



Canon

English Edition

SERVICE MANUAL

By Portable Document Format

EOS KISS DIGITAL X
EOS DIGITAL REBEL XTi
EOS 400D DIGITAL

C12-6151, 2

C12-6153, 4

C12-6155, 6

Preface

General

Technical

Repair

Adjustments

Parts Catalog

Circuit Diagrams

Software

Appendix

CLOSE

Canon

**EOS KISS DIGITAL X
EOS DIGITAL REBEL XTI
EOS 400D DIGITAL**

**REF. NO. C12-6151, 2
C12-6153, 4
C12-6155, 6**

SERVICE MANUAL

PREFACE

This manual contains information for servicing the product, and has the following sections:

General Information

Provides the basic information needed to understand the product.

(Operating instructions are not included. Refer to the products instruction book if necessary.)

Technical Information

Provides technical information about the mechanism and electronics of the product.

Repair Information

Provides information about disassembly and assembly, as well as tools and expendables to be used.

Adjustments

Provides information about adjustment items and procedures, as well as tools to be used.

Parts Catalog

Circuit Diagrams

Software Information

Appendix

General Information

Trademarks

The product names and company names described in this Service Manual are the registered trademarks of the individual companies.

Copyright

Canon Inc. retains the copyright to this Service Manual. Reproduction, publication (including on the World Wide Web), alteration, translation into another language, or other use of the data in whole or part, contained on this Service Manual without the written consent of Canon Inc. is prohibited.

CONTENTS

	Page
General Information	
1. FEATURES	1
1.1 High precision and high image quality	1
1.2 Dust-removal measures	1
1.3 Quick and easy shooting	1
1.4 Advanced features while retaining EOS KISS DIGITAL N's best features	2
1.5 Compact, lightweight, and luxury design	2
2. OVERVIEW	3
2.1 EOS D REBEL XTI / EOS 400D D body	3
3. DESIGN SPECIFICATIONS	17
4. NOMENCLATURE	46
4.1 Nomenclature	46
4.2 Dimensions	47
5. VISUAL INDICATORS	48
5.1 Viewfinder Information	48
5.2 LCD Panel Information and Model Dial	49
5.3 Functional display screens	51
5.4 LCD Monitor Menus	52
6. CUSTOM FUNCTIONS	57
6.1 Custom Function List	57
7. PROGRAM DIAGRAMS	58
7.1 Program Diagrams	58
7.2 E-TTL II autoflash program line	58
8. SYSTEM ACCESSORIES COMPATIBILITY TABLES	59
8.1 System Accessories	59
8.2. System Accessory Compatibility	60
9. OPERATION CAUTIONS	61
9.1 Agreed Answers for User Support	61

1. FEATURES (IMPROVEMENTS OVER THE EOS KISS DIGITAL N INDICATED IN BLUE.)

1.1 High precision and high image quality

- Highest resolution in its class: Approx. 10.1 effective megapixels, very fine and high image quality
- Large, single-plate 22.2 × 14.8mm CMOS sensor
 - Effective angle of view: Equivalent to 1.6 × normal EF lens focal length
- DIGIC II imaging engine for high-precision and natural color reproduction at high speed
- Picture Style for obtaining optimum images matching your shooting objective
 - Pressing the SET button displays the Picture Style selection screen.
- Six JPEG recording modes, RAW, RAW+JPEG (L/F) simultaneous recording
- Optimum auto white balance
- WB correction and WB bracketing provided
- Noise level detection, automatic noise reduction provided
 - [Auto] has been added to the long-exposure noise-reduction feature.
- Complies to Design rule for Camera File system 2.0 (compatible with Adobe RGB) and Exif 2.21

1.2 Dust-removal measures

- Three dust-removal measures
 - ① Self Cleaning Sensor Unit
 - Dust adhering on the front of the CMOS sensor is automatically removed.
 - ② Dust Delete Data detection and incorporation
 - The location and size of the dust adhering on the front of the CMOS sensor is detected, and Digital Photo Professional is used to erase the dust spots.
 - ③ Manual sensor cleaning

1.3 Quick and easy shooting

- Wide-area, high-speed, 9-point AF with center AF point compatible with f/2.8 lenses
- Startup time approx. 0.2 sec.
- Max. continuous shooting at 3 fps
- Continuous shooting: Max burst approx. 27 shots in JPEG Large/Fine, approx. 10 shots in RAW.
 - Based on Canon's testing standards and a 512MB CF card.
- 1/4000 sec. - 30 sec., bulb, X-sync at 1/200 sec.
- Wide 2.5-in. LCD monitor with approx. 230,000 pixels
 - Wide field of view of approx. 160° both vertically and horizontally. Easier-to-read (larger) menu text.
 - Brightness can be adjusted in 7 levels. Max. brightness is approx. 40% brighter than previous models. (EOS-1D Mark II, 5D and 30D).
 - Camera settings are displayed on the large LCD monitor in a similar layout as on an LCD panel. For shooting settings, the current mode, etc., is highlighted for better readability.
- Quickly selectable AF mode, ISO speed, metering mode, and WB mode
 - Cross keys are assigned to the above functions. On the displayed screen, select the desired setting and press the shutter button halfway.
- USB 2.0 Hi-Speed for fast image transfers to a personal computer

1.4 Advanced features while retaining EOS KISS DIGITAL N's best features

- Flash exposure compensation and other shooting features retained
- Compatible with all EF lenses, including EF-S lenses
- Eleven Custom Functions with 29 settings
- Improved Print/Share feature
 - Complete array of PictBridge features.
 - Print/Share button for easy printing and image transfer.
 - Image transfers to a personal computer as controlled by the camera.

1.5 Compact, lightweight, and luxury design

- 126.5 (W) × 94.2 (H) × 65 (D) mm, Weight: 510g
 - The depth is 1 mm thicker than the EOS KISS DIGITAL N.
- Stylish and classy form, exuding high reliability
 - The Canon logo has filled-in color.

2. OVERVIEW

2.1 EOS D REBEL XTI / EOS 400D D body

While retaining the EOS KISS DIGITAL N's basic concept of being compact, lightweight, and easy to use, the entry-level EOS D REBEL XTI / EOS 400D D boasts a major upgrade of the EOS KISS DIGITAL N's core features. They include a sensor with 10.10 effective megapixels (the highest in this camera class), a sensor with an automatic dust reduction system, Picture Styles, wide-area and high-speed 9-point AF, and a 2.5-in. LCD monitor.

The major features are outlined below, centering on the improvements over the EOS KISS DIGITAL N.

Table 001 Specifications Comparison of EOS D REBEL XTI / EOS 400D D and EOS KISS DIGITAL N
(Items in indicate advantages over the EOS KISS DIGITAL N.) (1/2)

Specification		EOS D REBEL XTI / EOS 400D D	EOS KISS DIGITAL N	
Image sensor	Image sensor	CMOS		
	Effective pixels [Approx. megapixels]	10.10	8.00	
	Image sensor size [mm]	22.2×14.8		
	Lens Crop Factor (35mm format)	1.6		
	Dust-delete feature	Auto	Yes	—
		Software	Yes	—
		Manual	Yes	
Color filter system	Primary colors			
Recording System	Recording media	Compact Flash		
	Slot Type/Qty	CF Type I, II/1		
	Image Type	JPEG	1. Large/Fine 2. Large/Normal 3. Medium/Fine 4. Medium/Normal 5. Small/Fine 6. Small/Normal	
		RAW	7. RAW+Large/Fine 8. RAW	
	RAW+JPEG simultaneous rec.	Separate RAW & JPEG (Large/Fine) images		
	Recorded pixels [Approx. megapixels]	Large	10.10	8.00
		Middle	5.30	4.15
		Small	2.50	2.00
		RAW	10.10	8.00
	Color space	sRGB	Yes	
		Adobe RGB	Yes (Exif2.21)	
	Image processing	Picture Style	Processing parameter	
	Max. images per folder	9999	100	
	Manual reset of file numbering	Yes	—	
Noise reduction	Auto / On / Off	On / Off		
Compatible Card Capacity	2 GB and higher			
Imaging processor	DIGIC II			
White Balance	Detection system	Image sensor		
	Settings	1. Auto / 2. Daylight / 3. Shade / 4. Cloudy / 5. Tungsten light / 6. White Fluorescent light / 7. Flash / 8. Custom		
	WB correction [levels]	Blue/amber bias: ±9 Magenta/green bias: ±9		
	WB bracketing	Amount	±3 levels in 1-level increments	
		Direction	Blue/amber bias Magenta/green bias	
Shutter Release		3 images with one shot		
Viewfinder	Coverage [Approx. %]	95		
	Magnification [×]	0.8		
	Eye point [mm]	21		
	Dioptric adjustment [dpt]	-3 - +1		
	Focusing Screen	Precision Matte		
	Depth-of-field Preview	Yes		
Autofocus	AF Points	9	7	
	Cross-type AF at f/2.8	Yes	—	
	Metering range [EV]	-0.5 - 18	0.5 - 18	
	AF Point Selection	Cross-type keys / Main dial		
	AF Mode	One-Shot / AI SERVO / AI Focus		
	User-selectable AF mode	Yes		
	Superimposed display	Illuminated dot within AF point		
	50 kph predictive AF [EF300mm f/2.8L IS USM, approx. m]	10		
	AF-assist beam	Stroboscopic flash		

Table 001 Specifications Comparison of EOS D REBEL XTI / EOS 400D D and EOS KISS DIGITAL N
(Items in indicate advantages over the EOS KISS DIGITAL N.) (2/2)

Specification		EOS D REBEL XTI / EOS 400D D	EOS KISS DIGITAL N	
Exposure Control	Sensor Zones	35		
	Metering range [EV]	1 - 20		
	Metering modes	Evaluative / Partial / Center-weighted averaged		
	User-selectable metering mode	Yes		
	Shooting Modes	1. Full Auto 2. Portrait 3. Landscape 4. Close-up 5. Sports 6. Night Portrait 7. Flash Off 8. Program AE 9. Shutter-priority AE 10. Aperture-priority AE 11. Manual exposure 12. Automatic Depth-of-field AE		
	ISO Speed	Basic Zone	Auto (100 - 400)	
		Creative Zone	100, 200, 400, 800, 1600	
	Exposure Compensation [increments and range]	1/3, 1/2 • ±2		
	AEB [increments and range]	1/3, 1/2 • ±2		
	AE Lock	Yes		
Flash exposure control	Evaluative metering	E-TTL II		
	Averaged metering	Yes (C.Fn-8-1)		
Shutter	Speeds [sec.]	1/4000 - 30, bulb, X=1/200		
Drive	Drive Modes	Single / Continuous / Self-timer		
	Continuous shooting [Approx. sec.]	One-Shot	3	
		AI SERVO	3	
	Max. Burst [Approx. shots]	JPEG	27	14 (Large/Fine)
	RAW	10	5	
Built-in Flash	GNo. [ISO100 • m]	13		
	Flash Coverage [mm]	17		
	Flash Exposure Compensation [increments and range]	1/3, 1/2 • ±2		
	FE Lock	Yes		
LCD Monitor	Screen Size [in.]	2.5	1.8	
	Pixels displayed [Approx.]	230,000	115,000	
	Viewing angle	Vertical/Horizontal: 160°	20° up, 60° down, 40° left/right	
	Brightness Levels	7	5	
Playback	Display Modes [Types]	Single (Basic info / Info / No info) / Index		
	Histogram	Brightness	Yes	Yes
		RGB	Yes	—
	Highlight alert	Yes		
	Zoom-in magnification [Approx. ×]	1.5 - 10 (During image review/playback)	1.5 - 10 (Playback)	
	Jump	By 10 shots / 100 shots / date		
	Image Rotation	Yes (90°, 270°)		
Image protect	Yes			
Menu Languages	15			
Custom Functions [Qty/settings]	11/29	9/24		
Recording format	Design rule for Camera File System [Ver.]	2.0		
	Exif [Ver.]	2.21		
Direct Printing / Printing	PictBridge (PTP) Compatibility	Yes (Extended functions)	Yes	
	CP/BJ Direct Compatibility	Yes		
	Direct Print	Yes		
	DPOF [Ver.]	1.1		
Direct Image Transfer	Yes	—		
Camera setting display / Guide function	LCD monitor (large-size display) / Yes	LCD monitor / —		
External Interface	USB [Ver.]	2.0 Hi-Speed		
	Video OUT (NTSC/PAL)	Yes		
	Remote control terminal	Yes (RS-60E3)		
	Wireless remote control	Yes (RC-1, RC-5)		
Startup time [Approx. sec.]	0.2	0.2		
Power Source	Possible Shots [23°C/73°F, FA50%]	360	400	
	Batteries	NB-2LH		
	AC Power	Yes		
	Date/Time Backup Battery	CR2016		
	Battery Grip	BG-E3 (size-AA batteries compatible)		
Exterior	Material	Plastic		
	Exterior Color	Silver / black		
	EF-S lens compatible	Yes		
Chassis Material	Stainless steel + plastic			
Dimensions [W × H × D]	126.5×94.2×65 mm	126.5×94.2×64 mm		
Weight [g]	510	485		

EOS D REBEL XTi / EOS 400D D

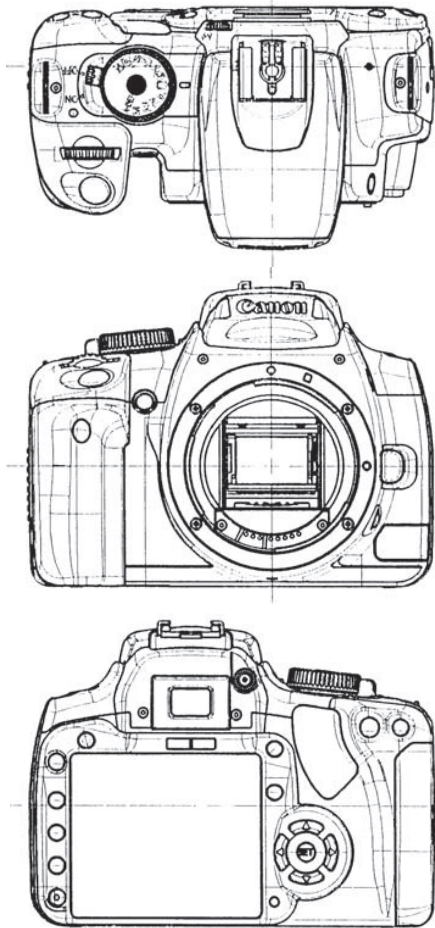

EOS KISS DIGITAL N

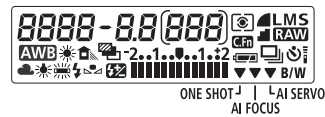
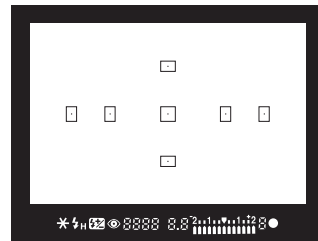
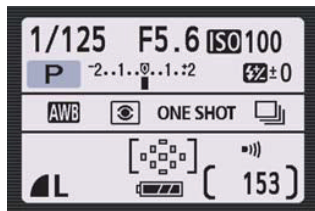
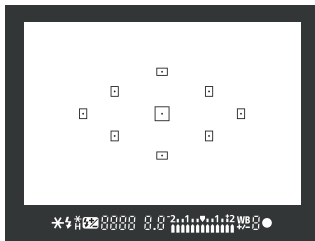
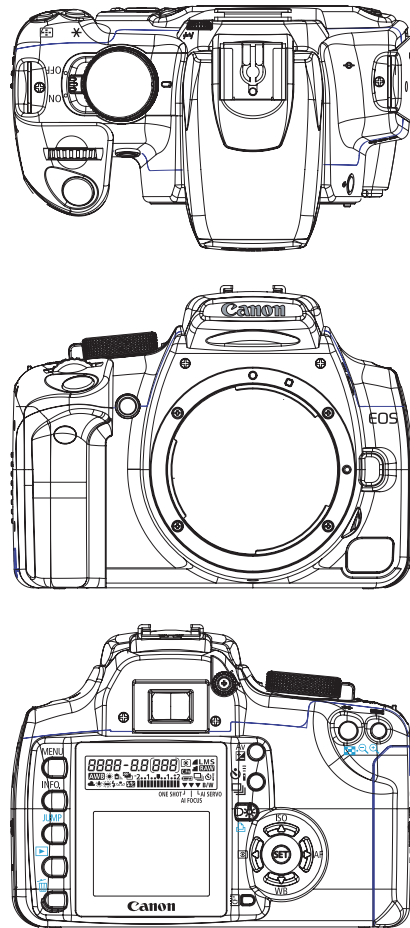

Fig. 001 EOS D REBEL XTi / EOS 400D D: Exterior comparison with EOS KISS DIGITAL N

1) Image recording

(1) Large CMOS sensor with approx. 10.10 effective megapixels

The CMOS sensor (Fig. 002) is 22.2 mm × 14.8 mm with 10.10 effective megapixels (the highest in this camera class). The effective lens crop factor is 1.6×.

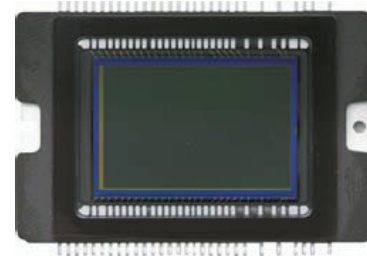

Fig. 002 CMOS sensor (actual size)

(2) DIGIC II

As with the EOS KISS DIGITAL N, the DIGIC II imaging engine is incorporated to obtain fine-detail and natural color reproduction at high speed.

(3) Recording quality

As with the EOS KISS DIGITAL N, six JPEG recording modes and RAW and RAW+JPEG are provided. Table 002 shows the number of pixels recorded in each recording mode.

Table 002 Image-Recording Pixels

Image-Recording Quality	Pixels
Large	3888 × 2592 (10.10 megapixels)
Medium	2816 × 1880 (5.30 megapixels)
Small	1936 × 1288 (2.50 megapixels)
RAW	3888 × 2592 (10.10 megapixels)

(4) ISO speed

As with the EOS KISS DIGITAL N, ISO 100 - 1600 can be set in whole-stop increments.

(5) Folder operations

● Maximum images per folder

Since up to 9999 images can be saved in a folder, the number of folders can be reduced to make it easier to find an image. The EOS KISS DIGITAL N required too many folders making it difficult to find an image.

● File numbering

The File numbering menu now has the Manual reset option (Fig. 003). This resets the file numbering to 0001 and saves subsequent images to a new folder. The folder cannot be user selected.

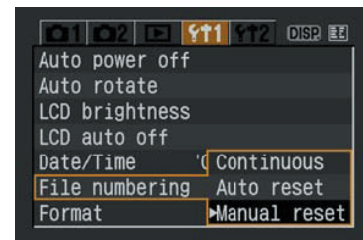

Fig. 003 File numbering screen

2) Image processing

(1) Picture Styles

The same Picture Styles found in the EOS 30D are incorporated. In the Creative Zone modes, when you press the SET button, the Picture Style selection screen appears (Fig. 004). It is now easier to select a Picture Style.

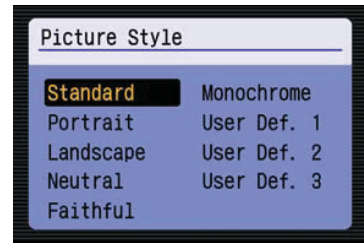

Fig. 004 Picture Style selection screen

(2) Noise reduction

As with the EOS 30D, the [Long exp. noise reduction] Custom Function can be set to [Off], [Auto], or [On].

With [Auto], noise reduction is performed automatically for exposures 1 sec. or longer if the noise peculiar to long exposures is detected. [On] can be set if the [Auto] setting fails to detect and reduce the noise. Note that while the noise reduction is performed on an image, the camera cannot take any pictures.

(3) White balance

The white balance settings, white balance correction, and bracketing are the same as with the EOS KISS DIGITAL N.

3) Dust reduction

The EOS D REBEL XTi / EOS 400D D is the first EOS DIGITAL camera to have the automatic dust reduction feature of imaging sensor to remove dust and bundled software to obtain Dust Delete Data to erase dust spots automatically. As with previous models, manual cleaning of the sensor is also possible.

(1) Self Cleaning Sensor Unit

Dust adhering to the low-pass filter in front of the sensor is removed by ultrasonic vibration (Fig. 005).

Normally, when the power switch is turned on or off, the Self Cleaning Sensor Unit operates automatically for about 1 sec. to remove any dust. The system can also be activated manually with a menu (Fig. 006). Since shooting-priority still takes effect, pressing the shutter button during the self-cleaning operation will interrupt the self-cleaning and return the camera to shooting ready.

The vibration and noise levels during the operation of the Self Cleaning Sensor Unit are low enough to be unnoticeable. You can hear a whispery noise only if you put the camera next to your ear during the self-cleaning operation.

The removed dust is held by dust-sticker material around the low-pass filter to prevent it from adhering to the sensor again.

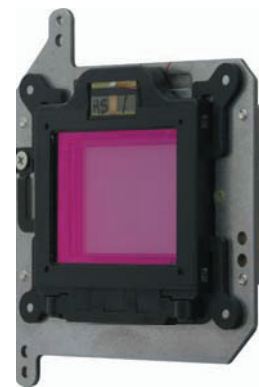

Fig. 005 Self Cleaning Sensor Unit

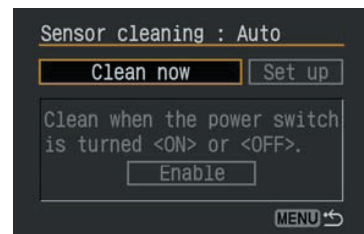

Fig. 006 Self Cleaning Sensor setting screen

(2) Dust Delete Data detection

The location and size of the dust adhering to the low-pass filter is detected, and that information is appended to the image data. The dust spots can then be removed from the image with Digital Photo Professional Ver 2.2's auto dust deletion feature (Ver.2.1 enhanced function of Copy Stamp tool).

The location and size of the dust is detected with the procedure using the [Dust Delete Data] menu as shown in Fig. 007. First, a picture of a solid-white, patternless object is taken very out of focus at a small aperture. It then takes about 6 sec. to obtain the Dust Delete Data.

When [OK] is selected in step 2 below, the Self Cleaning Sensor Unit will first operate, then it will go to the next step. The data for any dust not removed by the self-cleaning operation is obtained.

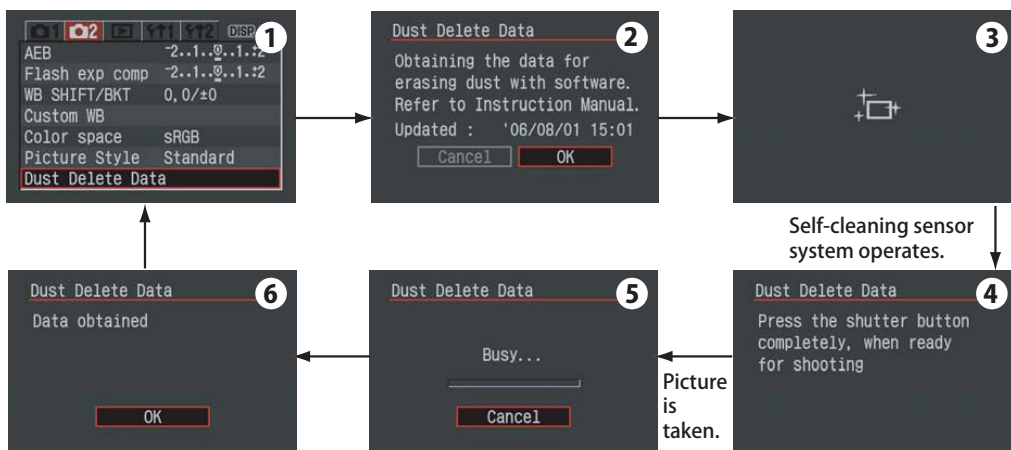

Fig. 007 Steps to obtain the Dust Delete Data

Shooting Conditions

- Attach a 50mm or longer lens to the camera.
- Use manual focus and set it to infinity.
- Set the subject distance to 20 - 30 cm/0.7 - 1.0 ft. Fill the viewfinder frame with a solid-white, patternless object and take the picture.
- The image data can be obtained even without a CF card installed in the camera.

When the screen in step 4 appears, the camera will be set automatically as shown in the table below:

Shooting Mode	Aperture-priority AE	Aperture	f/22
Shutter speed	1/2 sec. or faster	ISO Speed	800
Flash	Off	Drive Mode	Single

* Even if the focus mode is set to <AF>, manual focus will still take effect.

* Even if a CF card is installed in the camera, the image taken for the dust deletion will not be recorded.

The Dust Delete Data is appended to all subsequent images until it is updated again (via the above procedure). It is recommended to update the Dust Delete Data before a big shoot or after changing lenses in a dusty place. Digital Photo Professional uses the dust deletion data to detect the location of dust. If it deems that dust deletion would be effective, it automatically executes dust deletion at that location in the image.

If you want to stop the Dust Delete Data from being appended to the images, the Dust Delete Data must be erased. It can be erased with the [Clear all camera settings] menu.

4) Shooting Features

(1)Autofocus

● AF sensor

The EOS D REBEL XTi / EOS 400D D uses the same 9-point AF sensor (Fig. 008) as the EOS 30D. With f/2.8 and larger aperture lenses, the center AF point works as a high-precision, cross-type sensor. The AF can operate under ambient lighting ranging from EV -0.5 to EV 18. This range is one stop wider in low light than the EOS KISS DIGITAL N's.

*The EOS D REBEL XTi / EOS 400D D is Canon's first entry-level SLR with 9-point AF and cross-type sensor compatible with f/2.8.

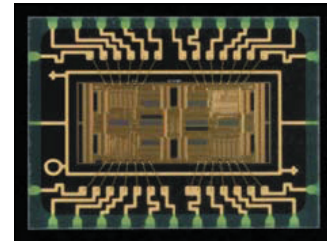

Fig. 008 AF sensor

●Selectable AF mode

In the Creative Zone modes, the AF mode (One-Shot AF, AI SERVO AF, or AI Servo AF) is user selectable.



Fig. 009 AF mode selection screen

●Selectable AF point

You can select the AF point by pressing the cross keys (or turning the main dial) while looking at the AF point selection screen (Fig. 010) or the superimposed AF points in the viewfinder. You can also toggle between automatic AF point selection and center AF point selection by pressing the SET button.

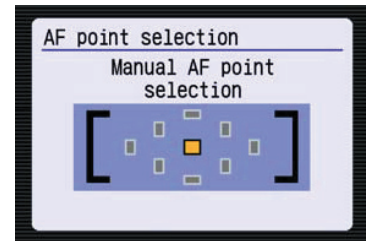

Fig. 010 AF point selection screen

(2)Drive mode

At a continuous shooting speed of approx. 3 fps, a maximum burst of 27 shots in Large/Fine mode is possible. The maximum burst in RAW mode is 10 shots (about twice that of the EOS KISS DIGITAL N). Although the higher number of pixels makes the image file size larger, continuous shooting still gives ample performance.

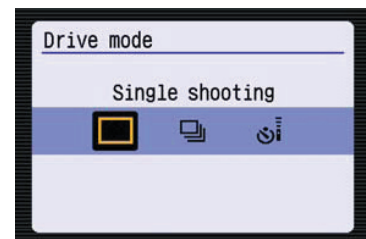

Fig. 011 Drive mode selection screen

(3)Shutter

The shutter unit has the same basic configuration as the EOS KISS DIGITAL N's. The shutter speed range is 1/4000 sec. - 30 sec. Bulb and X-sync at 1/200 sec. are also provided.

(4)Exposure control

The shooting modes, 35-zone metering sensor, and metering modes (evaluative, partial, center-weighted average metering) are all the same as the EOS KISS DIGITAL N's.

(5)Viewfinder

The focusing screen is the same Precision Matte screen as the EOS KISS DIGITAL N's.

Compared with the EOS KISS DIGITAL N, the viewfinder information has the following additional information (red-eye reduction icon eliminated):

- FE lock icon (blinks during FEB shooting)

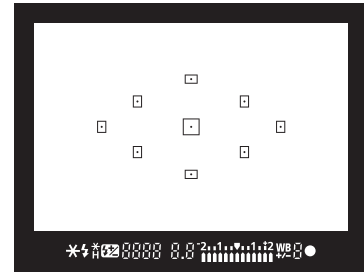

Fig. 012 Viewfinder

(6)Built-in flash

The built-in flash and control method are the same as the EOS KISS DIGITAL N's.

The icon displayed for flash exposure compensation set with the built-in flash is now different from the icon displayed for flash exposure compensation set with the external Speedlite. This enables the user to know which flash unit was used to set the flash exposure compensation. (Fig. 013)

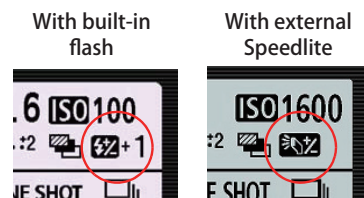

Fig. 013 Flash exposure compensation icon

(7)Compatible with EF-S lenses

The camera is compatible with all EF lenses including EF-S lenses.

5) Large-size LCD monitor and display

This is a 2.5-in. TFT LCD color monitor with about 230,000 pixels. It provides very fine image detail and a wide viewing angle. With the larger LCD monitor, the text in the menus is also bigger and easier to read.

(1) Camera setting display

Instead of having a separate LCD display panel, the EOS D REBEL XTI / EOS 400D D displays the camera settings on the LCD monitor in a similar layout as on an LCD panel. The settings are displayed when the camera is turned on. As shown in Fig. 014, the camera settings look larger on the 2.5-in. LCD monitor, making it easier to read than on the EOS KISS DIGITAL N. A lot of information is also displayed. Settings like the ISO speed, recording quality, white balance, and other information you need to always check are displayed. In the Basic Zone modes, the settings which the user cannot change is grayed out. (Fig. 015)

Cameras having a separate LCD panel always display the essential camera settings while the camera is turned on. So with the EOS D REBEL XTI / EOS 400D D, the camera settings are displayed at all times whenever possible.

If you press the shutter button halfway while viewing a menu or image on the LCD monitor, the camera settings will reappear. And as with other EOS DIGITAL cameras, you can start shooting anytime from any display mode.

If auto power off is disabled and the camera is left on, the LCD monitor will automatically turn off after 30 minutes. (Power will not turned off.)
 *Normally, the camera settings are displayed whenever the camera is turned on. To save battery power, you can have the LCD monitor remain OFF even after you turn on the camera's power switch. To do this, set C.Fn-11 [LCD display when power ON] to [Retain power OFF status]. This setting enables the camera to startup with the same LCD monitor status (ON/OFF) as when the power was turned off.

● LCD monitor brightness

LCD monitor is now adjustable in 7 levels, one level each expanded compared to previous models in both bright and dark sides. At its brightest setting, it can display the image about 40% brighter than at the brightest setting of EOS-1D Mark II, 5D and 30D. It makes it easier to review the images even in brightly lit outdoors. As for the darkest setting, the display is not too bright for your eyes to see even in the dark.

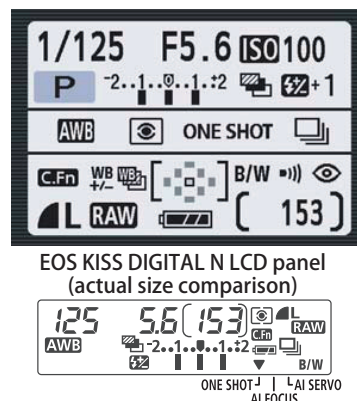

Fig. 014 Camera setting display

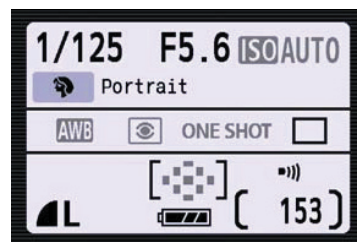

Fig. 015 Basic Zone mode display

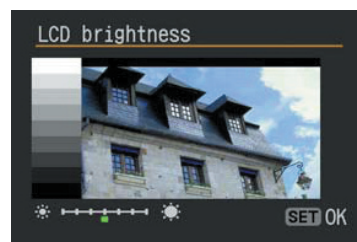

Fig. 016 LCD monitor brightness settings screen

● Display-off sensor

When your eye approaches the viewfinder eyepiece, the display-off sensor (Fig. 017) detects your face and turns off the LCD monitor automatically. This is to prevent the LCD monitor from being too bright for the eye. This display-off sensor can be disabled by setting the [LCD auto off] menu to [Disable].

The camera setting display can also be turned off and on manually with the <DISP> button (formerly INFO.). If the camera setting display is disabled, it will be difficult to discern whether the camera is turned on or not. A power lamp is therefore provided to indicate that the camera is on.

*Other than the face, any object that comes near the display-off sensor will turn off the camera setting display temporarily. The camera settings will be displayed again when the face or object goes away from the camera.

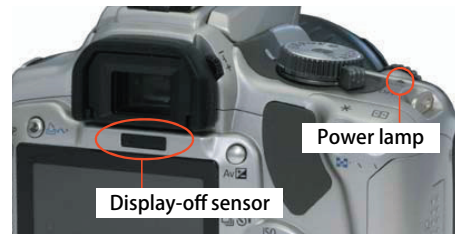

Fig. 017 Display-off sensor

(2) Menu display

As with the EOS KISS DIGITAL N, the tabbed menu screens are operated with the cross keys and SET button. Menu operation is possible even during the image writing to the CF card after continuous shooting. Note that functions already assigned to cross keys (ISO speed, etc.) are not included in the menus. Regarding the new and changed items, see the respective item's description.

*For a description of the menu options, see pages 52-56.

Table 003 Menu options

Shooting 1 menu	Shooting 2 menu	Playback menu	Set-up 1 menu	Set-up 2 menu
Quality	AEB	Protect	Auto power off	Language
Red-eye On/Off	Flash exp comp	Rotate	Auto rotate	Video system
Beep	WB SHIFT/BKT	Print order	LCD brightness	Custom Functions (C.Fn)
Shoot w/o card	Custom WB	Transfer order	LCD auto off	Clear settings
	Color space	Auto play	Date/Time	Sensor cleaning : Auto
	Picture Style	Review time	File numbering	Sensor cleaning : Manual
	Dust Delete Data	Histogram	Format	Firmware Ver.

: New item
 : Changed item

When an error occurs, the probable cause and solution are now displayed. (Fig. 018)

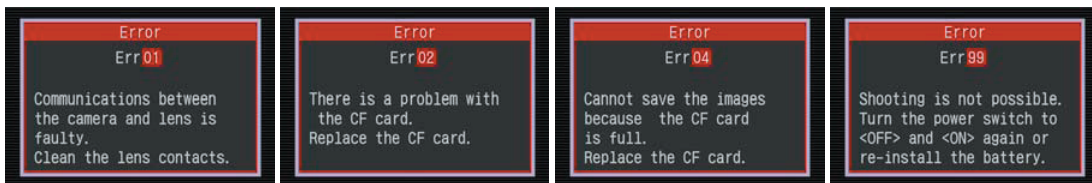

Fig. 018 Error information screen

(3) Image playback

● Magnified view

When C.Fn-10 for magnified view is set to [Image review and playback], magnified view will be possible during the image review immediately after shooting.

● Image information display

On the [Histogram] menu, either the [Brightness] or [RGB] can be selected for the histogram display. The image file size is also displayed. (For RAW+JPEG images, the JPEG file size is displayed.)



Fig. 019 Shooting information screen

● Rotation of vertical images

To display vertical images vertically on the camera's LCD monitor or personal computer screen (with compatible software), you now have a choice of rotating the vertical image to display it vertically on both the camera and personal computer or only on the personal computer or not rotating it at all.

*After shooting, if you set the [Rotate] menu to rotate vertical images and [Auto rotate] has been set to rotate the image on both the camera and personal computer, the image will be rotated in the specified direction for playback. If the image is set to rotate only on the personal computer or not rotate at all, then the image will not be rotated for the playback. (Same as with EOS 30D.)

6) Design and operation ease

(1) Design

While retaining the EOS KISS DIGITAL N's concept of being a stylish, compact and advanced digital SLR, the EOS D REBEL XTi / EOS 400D D has the following exterior and operation ease improvements.

● Exterior

- The black body has a leathery finish to make fingernail scratches less noticeable. The exterior looks solid and profound for a luxury look.
- The Canon logo is bigger to make it stand out better in the camera store.

● Operation ease

- To improve the holding ease for the right hand, a new grippy rubber for the thumb and a new grip shape have been incorporated. The grip is also thicker by 1 mm.
- The Print/Share button is now on the upper left on the back of the camera where the digital control buttons are concentrated. By clearly separating the digital control buttons and camera control buttons, the camera is easier to operate.

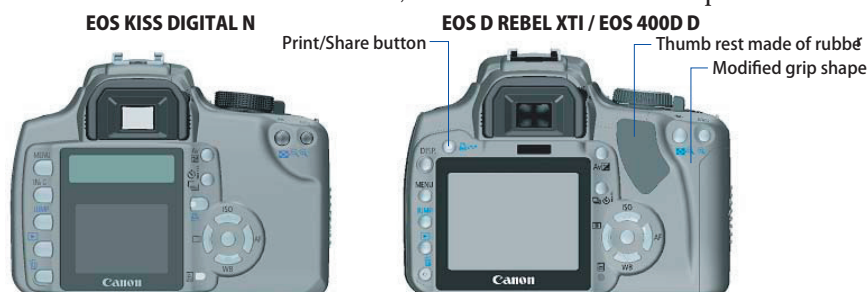

Fig. 020 Camera back

(2)Basic operation

●Startup time

Fast startup time taking approx. 0.2 sec. for the camera to be able to shoot after the power switch is turned on.

●Basic operation

Except for the cross keys assigned with functions such as the ISO speed setting, the basic camera controls are the same as with the EOS KISS DIGITAL N. The camera setting screen (Fig. 021 and 022) has an easy-to-read interface with the current active mode highlighted.

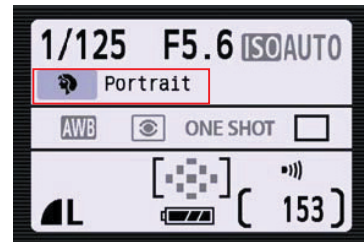

Fig. 021 Basic Zone mode screen

Cross key function assignments

The cross keys assigned with functions (ISO speed, AF mode, white balance, and metering mode settings) in the Creative Zone modes each display a dedicated screen (Fig. 022) for selecting the desired setting. This is an improvement over the EOS KISS DIGITAL N whose cross keys worked as a short-cut button to display the respective menu. The desired setting can be selected by using the cross key or main dial to select the setting or mode, and then pressing the shutter button halfway. The camera setting display will then reappear. Pressing the shutter button fully captures the image with the selected setting or mode in effect. This is similar to the EOS 30D's operation.



Fig. 022 Screens for cross key functions

About the <DISP> button

The <DISP> button turns the camera setting display on or off. However, if you press the button while a menu is displayed or during image playback, it works in the same way as EOS KISS DIGITAL N's <INFO> button.

In other words, if you press the <DISP> button while the menu is displayed, the camera setting display (Fig. 023) will appear. And if you press the <DISP> button during image playback, the shooting data will be displayed. During direct printing, the button toggles between a horizontal and vertical trimming frame.



Fig. 023 Camera Setting Display

7) Camera direct printing

(1)Interface

The USB 2.0 Hi-Speed port enables high-speed image transfers from the camera to a personal computer. Also, the PTP protocol is now used for both camera direct printing and transmissions to a personal computer. This makes it unnecessary to switch the communications setting.

(2)Camera direct printing

As with the EOS 30D, the paper size, printing effects, printing effect adjustment, printing layout capabilities and enhanced trimming options are provided. A Print/Share button is also provided. And in the EOS D REBEL XTI / EOS 400D D, the USB cable can now be disconnected when the image transfer to the printer is completed. (only possible with the printer compatible with this feature)

* After printing is started, <Print/Share> button' s blue lamp will blink during image transfer. When it is finished, it will light in blue, and then USB cable can be disconnected.

(3)Direct image transfer

As with the EOS 30D, images can be transferred directly to a personal computer just by operating the camera.

8) Custom Functions

Table 004 shows the Custom Functions provided.

* See page 53 for a description of each Custom Function.

Table 004 Custom Functions

C.Fn	Item
1	SET button/Cross keys funct.
2	Long exp. noise reduction
3	Flash sync. speed in Av mode
4	Shutter/AE lock button
5	AF-assist beam
6	Exposure level increments
7	Mirror lockup
8	E-TTL II
9	Shutter curtain sync.
10	Magnified view
11	CD display when power ON
	: New item
	: Changed item

9) Power source and battery life

The power source system is the same as the EOS KISS DIGITAL N's: Battery Pack NB-2LH, Battery Grip BG-E3, and AC Adapter Kit ACK-DC20.

With a fully-charged NB-2LH at 23°C/73°F, approx. 500 shots can be taken without flash use. With 50% flash use, approx. 370 shots can be taken.

* With the EOS KISS DIGITAL N: Approx. 600 shots without flash and approx. 400 shots with 50% flash use.

As with the EOS KISS DIGITAL N, the date/time backup battery is a lithium CR2016 battery housed in the battery compartment.

10) Dimensions and weight

Dimensions: 126.5 (W) × 94.2 (H) × 65 (D) mm / 4.98 (W) × 3.71 (H) × 2.56 (D) in.,

Weight: 510 g / 18 oz.

*To improve holding comfort, the grip was made slightly thicker. This has increased the camera depth dimension by 1 mm compared to the EOS KISS DIGITAL N.

*The weight is 25g heavier than the EOS KISS DIGITAL N, so as to accommodate the Self Cleaning Sensor Unit. EOS KISS DIGITAL N's weight is 485 g / 71.1 oz.

11) Accessories

The EOS D REBEL XTI / EOS 400D D is compatible with all EOS KISS DIGITAL N accessories. There are no new accessories.

3. DESIGN SPECIFICATIONS

(Specifications different from the EOS KISS DIGITAL N are indicated in blue.)

1. Type
 - 1-1 Type: Digital AF/AE single-lens reflex camera with built-in flash
 - 1-2 Compatible lenses: Canon EF and EF-S lenses
 - 1-3 Lens mount: Canon EF mount
 - 1-4 Lens restrictions: None
 - 1-5 Lens focal length: Equivalent to 1.6× the normal lens focal length

2. Image Sensor
 - 2-1 Type: High-sensitivity, high-resolution, single-plate, CMOS sensor
 - 2-2 Image sensor size: 22.2 mm × 14.8 mm
 - 2-3 Effective pixels: **Approx. 10.10 megapixels: 3904 (H) × 2598 (V) pixels**
 - 2-4 Total pixels: **Approx. 10.50 megapixels: 3996 (H) × 2622 (V) pixels**
 - 2-5 Pixel unit: **5.7 μm square**
 - 2-6 Aspect ratio: 2:3 (Vertical:Horizontal)
 - 2-7 Color filter type: RGB primary color filters
 - 2-8 Low-pass filter: Fixed position in front of the image sensor
 - 2-9 **Dust-delete feature:**
 - (1)Sensor cleaning: Auto (Menu)
 - The Self Cleaning Sensor Unit removes the dust adhering to the low-pass filter. Operation time is about 1 sec.
 - The self-cleaning can be enabled or disabled by setting "Clean when the power switch is turned <ON> or <OFF>" to [Enable] or [Disable]. Self-cleaning can also be performed immediately by selecting [Clean now].
 - (2)Dust Delete Data (Menu)
 - The coordinates of the dust adhering to the low-pass filter is detected by a test shot and the data is appended to the shooting data.
 - The Self Cleaning Sensor Unit operates automatically before the test shot is taken.
 - The dust coordinates appended to the shooting data is used by the bundled software to automatically erase the dust spots.
 - (3)Sensor cleaning: Manual (Menu)
 - Possible when a Battery Pack or AC adapter is used.
 - If the Battery Pack's power is inadequate or if BG-E3 size-AA batteries are used, manual cleaning will not be possible.
 - During manual cleaning with the reflex mirror locked up, the LCD monitor will indicate that sensor cleaning is in progress.
 - When the battery level is low, the following warnings are given: ①Beeper sound (It will sound even if [Beep] is set to [Off]). ②Warning message displayed on LCD monitor until the prohibited voltage is reached.

3. Recording System

3-1 Recording media: CF card

3-2 Media format: In accordance with the CF card
 (1)Formatted with the menu's [Format].
 (2)Compatible with 2 GB and higher CF cards.
 (3)The formatted CF card's volume name will be "EOS_DIGITAL."

3-3 Image type:

Image-Recording Quality		Pixels	Image Type
Large	Fine	3888×2592	JPEG
	Normal	(Approx. 10.10 megapixels)	
Medium	Fine	2816×1880	
	Normal	(Approx. 5.30 megapixels)	
Small	Fine	1936×1288	
	Normal	(Approx. 2.50 megapixels)	
RAW		3888×2592 (Approx. 10.10 megapixels)	Lossless RAW

3-4 RAW+JPEG simultaneous recording: RAW and JPEG (Large/Fine) images are recorded simultaneously.

3-5 File size and recording capacity:

Image-Recording Quality			Image File Size (Approx. MB)	Possible Shots (Approx. MB)
JPEG	Large	Fine	3.8	130
		Normal	2.0	249
	Middle	Fine	2.3	216
		Normal	1.2	410
	Small	Fine	1.3	376
		Normal	0.7	709
RAW			9.8	50
RAW+Large/Fine			—	36

*The above specifications are based on ISO 100 and Canon's testing standards.

*The number of possible shots is based on Canon's testing standards and a 512MB CF card.

*The actual single image size and possible shots depend on the subject, shooting mode, ISO speed, and [Picture Style](#).

*Since monochrome shooting produces smaller file sizes than with color, the number of possible shots will be higher.

3-6 Information recorded: Complies to Design rule for Camera File system.
 • The following is recorded when the image is captured: main, secondary (Exif information), manufacturer' s, thumbnails information.

3-7 Image recording format: Complies with Design rule for Camera File system 2.0 and Exif 2.21.

- 3-8 Folder setting:** 100CANON - 999CANON
- (1)If the CF card does not have a Design rule for Camera File system-compliant folder, one is created automatically.
 - (2)Another folder is created automatically if the file No. reaches 9999.
 - (3)If the folder No. reaches 999 and the file No. 9999, an [Err CF] message appears even if there is space remaining in the card. In that case, replace it with a different CF card. (When a newly formatted CF card is installed, the folder number starts from 100 and the image file number starts from 0001.)
 - (4)Up to 9999 images can be stored in a folder.
 - (5)If the [File numbering] menu is set to [Manual reset], a new folder is created and the image file numbering starts from 0001.
 - (6)Folder selection is not possible.
- 3-9 Image file name:** JPEG: IMG_****.JPG (The asterisks indicate the file number.)
RAW: IMG_****.CR2
- (1)If Adobe RGB is set, the "I" in IMG will be underscored.
 - (2)The extension for RAW images will be CR2 (Canon RAW 2nd Edition).
- 3-10 File No.:** The following **three types** of file numbers can be set:
- * If the folder No. reaches 999 and the file No. 9999, an [Err CF] message appears even if there is space remaining in the card. In that case, replace it with a different CF card (the number will start with folder No. 100 and file number 0001).
 - (1)Continuous numbering
 - * The continuous numbering of captured images will continue even after you replace the camera's CF card.
 - (2)Auto reset
 - * When you replace the camera's CF card, the numbering will be reset to start from 0001. If the new CF card already contains images, the numbering will continue from the last recorded image in the CF card.
 - (3)Manual reset
 - * The image file numbering is reset to 0001 and a new folder is created where subsequent images are saved.

3-11 Picture Style:

- 1)Basic Zone modes: Automatic settings
 - Portrait mode: Automatically set to "Portrait"
 - Landscape mode: Automatically set to "Landscape"
 - In shooting modes other than the above, automatically set to "Standard"
- 2)Creative Zone modes: Picture Style selection and settings are available. Default settings are as follows.

Item	Sharpness	Contrast	Color tone	Color saturation	Filter effect	Toning effect	PC Setting
①Standard	3	0	0	0	—	—	—
②Portrait	2	0	0	0	—	—	—
③Landscape	4	0	0	0	—	—	—
④Neutral	0	0	0	0	—	—	—
⑤Faithful	0	0	0	0	—	—	—
⑥Monochrome	3	0	—	—	None	None	—
⑦User Defined	3	0	0	0	—	—	Yes

- * If you press the JUMP button in modes ① to ⑦, you can adjust sharpness, contrast, color saturation, color tone, filter effects, and toning effects from their default settings.
- * You can use one of ① to ⑥ (or a Picture Style file set from the Camera Window software included in the package) as a base style, and adjust sharpness and other items, and register up to three styles of your own (⑦ User Defined 1-3).
- * Picture Style setting changes and registration can be done with the Picture Style menu screen. They cannot be done with the Picture Style selection screen which appears when you press the SET button.

3-12 Picture Style settings:

Item	Selections / Settings
Base style	Standard / Portrait / Landscape / Neutral / Faithful / Monochrome / Picture Style file
Sharpness	0 / 1 / 2 / 3 / 4 / 5 / 6 / 7
Contrast	-4 / -3 / -2 / -1 / 0 / +1 / +2 / +3 / +4
Color tone	-4 / -3 / -2 / -1 / 0 / +1 / +2 / +3 / +4
Color saturation	-4 / -3 / -2 / -1 / 0 / +1 / +2 / +3 / +4
Filter effect	N: None, Ye: Yellow, Or: Orange, R: Red, G: Green
Toning effect	N: None, S: Sepia, B: Blue, P: Purple, G: Green

- * A file for the color space will also be created for monochrome shooting.
- * During monochrome shooting, the camera setting display on the LCD monitor will show "B/W."
- * When C.Fn-01-2 (SET button func.: Picture Style) is set, pressing the SET button will display the Picture Style setting menu on the LCD monitor.
- * The settings will revert to the default settings if [Clear all camera settings] is set.

3-13 Color space:

- Selectable between sRGB and Adobe RGB.
 - Settable with the menu's [Color space].

4. Recording Media Drive

- 4-1 Type: Accepts CF card Types I and II
- 4-2 Slots: 1 slot with cover provided
- 4-3 CF card access indicator: Access lamp blinks
- 4-4 Read error warning: Error warning displayed in viewfinder and on LCD monitor. Shutter release is locked.
- 4-5 CF card initialization: Enabled
 - With the menu's [Format].
- 4-6 No CF card warning: Provided
 - (1)[No CF card] is displayed on LCD monitor.
 - (2)With the menu's [Shoot w/o card] the shutter release can be locked.

5. White Balance

- 5-1 Type: Auto white balance with the image sensor.
 - Pressing the bottom cross key displays [White balance].
- 5-2 Modes: Basic Zone modes: Set automatically to Auto (AWB)
Creative Zone mode: Selectable modes shown below.

	WB Mode	Color Temperature (Kelvin)
Auto	①Auto (AWB)	Approx. 3000 - 7000 K
Preset	②Daylight	Approx. 5200 K
	③Shade	Approx. 7000 K
	④Cloudy, twilight, sunset	Approx. 6000 K
	⑤Tungsten light	Approx. 3200 K
	⑥White fluorescent light	Approx. 4000 K
	⑦Flash	Approx. 6000 K
Manual	⑧Custom (MWB)*1	Approx. 2000 - 10000 K

* On the LCD monitor's camera setting display, the selected white balance mode's name and color temperature are displayed.

* 1 : Custom: First take a picture of a white subject serving as the white balance standard. Then set the [Custom WB] mode on the on-screen menu and to specify that image.

- 5-3 White balance correction: The color temperature of the WB modes (all listed in 5-2) can be corrected as follows:
 - (1)Blue/amber bias: ± 9 levels
 - (2)Magenta/green bias: ± 9 levels
 - Use the cross keys to adjust.
 - White balance correction cannot be applied outside 2000K - 10000K. (Although it is settable, the effect is not guaranteed.)

- 5-4 White balance bracketing:** Based on the color temperature of the current WB mode (among those listed in 5-2), WB bracketing for images at "Standard color temperature → blue bias → amber bias" or "Standard color temperature → magenta bias → green bias" is executed up to ± 3 stops in 1-stop increments with a single release of the shutter.
Bracketing range: up to ± 3 stops in 1-stop increments.
(1)The blue/amber bias and magenta/green bias cannot be set together.
(2)One level of the blue/amber bias is equivalent to 5 Mireds of a color conversion filter. For the magenta/green bias, there is no equivalent in Mireds.
(3)White balance correction cannot be applied outside 2000K - 10000K. (Although it is settable, the effect is not guaranteed.)
(4)When set together with white balance correction, WB bracketing cannot be set to more than ± 9 levels.
(5)White balance correction and AEB can also be set in combination with WB-BKT. (With AEB, 9 images will be saved to the CF card.)
(6)WB-BKT is not possible in RAW or RAW+JPEG modes.
(7)Since three images are recorded automatically with a single shot, the writing time to the CF card will take longer.

6. Viewfinder

- 6-1 Type:** Eye-level SLR (with pentamirror)
6-2 Focusing screen: Fixed
• Precision Matte
6-3 Dioptric adjustment: Adjustable from -3.0 dpt to +1.0 dpt.
6-4 Eye point: 21 mm
6-5 Coverage: Approx. 95% vertically and horizontally
6-6 Magnification: Approx. 0.8× (with 50mm lens at infinity, -1 dpt)

6-7 Viewfinder information:

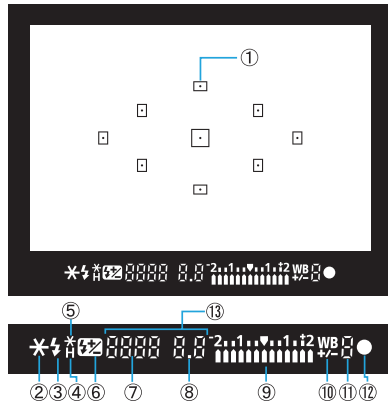

- 1) On the screen
 - ① AF points (9)
- 2) Below the screen (Major information)
 - ② AE lock, AEB in progress (blinks)
 - ③ Flash ready, insufficient flash warning during FE lock (blinks)
 - ④ High-speed sync (FP flash)
 - ⑤ FE lock, FEB shooting (blinks)
 - ⑥ Flash exposure compensation
 - ⑦ Shutter speed (if camera shake will occur, it blinks), bulb, FE lock (FEL), Processing data (buSY), built-in flash recycling (buSY)
 - ⑧ Aperture (if unsuitable, it blinks)
 - ⑨ Exposure level display: Exposure compensation, Manual exposure level, AEB level, Red-eye reduction lamp on time display
 - ⑩ White balance correction
 - ⑪ Max. burst
 - ⑫ AF focus confirmation (blinks when focus cannot be achieved), MF focus confirmation
 - ⑬ CF card full warning (FuLL CF), CF card error warning (Err CF), No CF card warning (no CF)

6-8 Mirror:

Quick-return half mirror (Transmittance:reflectance ratio of 40:60)

6-9 Viewfinder blackout time:

Approx. 170 ms at 1/60 sec. or faster speeds.

6-10 Mirror lockup:

Enabled with C.Fn-7-1.

- (1) SW-2 ON for mirror up → SW-1 OFF → SW-2 ON for shutter release.
- (2) Mirror lockup is maximum 30 sec. (after 30 sec., the mirror goes back down and exposure stops.)

6-11 Mirror cut-off:

No mirror cut-off with lenses up to EF600mm f/4L IS USM

6-12 Depth-of-field preview:

Enabled with depth-of-field preview button

- (1) Enabled in Creative Zone modes only.
- (2) With Speedlite 580EX, 550EX, 430EX, 420EX, MR-14EX, or MT-24EX, pressing the depth-of-field preview button fires a modeling flash.

6-13 Eyepiece shutter:

None (Eyepiece cover provided on strap)

6-14 Misc.:

Eyecup Ef provided

7. Autofocus

- 7-1 Type: TTL-CT-SIR with CMOS sensor
- 7-2 AF points: 9 AF points
- (1)The center AF point is sensitive to vertical and horizontal lines as a cross-type sensor (① a sensor sensitive to vertical lines to f/2.8, ② a two-line sensor sensitive to horizontal lines to f/5.6, ③ a sensor sensitive to vertical lines to f/5.6)
- (2)The remaining 8 points are sensors sensitive to vertical or horizontal lines to f/5.6.
- 7-3 Focusing modes: Press the right cross key to display [AF mode].
- The name of the selected AF mode is displayed in the camera setting display on the LCD monitor.
- 1)Autofocus
- In the Creative Zone modes, the following three modes can be selected:
- [One-Shot AF]
- When focus is achieved, the AF operation stops and locks (AF lock).
- (1)AF-priority (The shutter can be released only when focus is achieved.)
 - (2)During evaluative metering, AE lock is set when focus is achieved.
 - (3)In metering modes other than evaluative metering, exposure metering continues in real-time until the shutter is released.
 - (4)With applicable USM lenses, electronic ring manual focusing can be used after focus is achieved with One-Shot AF or if focus cannot be achieved with One-Shot AF.
 - (5)Automatically set in the Portrait, Landscape, Close-up, and Night Portrait modes.
- [Predictive AI Servo AF]
- Tracks subject movement and focuses continuously until the start of exposure.
- (1)1st shot during SW-1 ON
 - Creative Zone modes: Shutter-release priority (shutter releases after the lens drive stops during focusing).
 - Sports, Full Auto, No Flash modes (AI Servo AF): AF priority
 - (2)2nd shot onward during continuous shooting: Shutter releases after the lens drive stops during subject tracking.
 - (3)Set automatically in the Sports mode, beeper sounds. No focus confirmation light.
 - (4)Creative Zone modes: No beeper, no focus confirmation light.
 - (5)If focusing is impossible, the focus confirmation icon blinks.
 - (6)The USM lens' electronic manual focusing will work if the camera cannot autofocus the subject.

- [AI Focus AF (Automatic switching between One-Shot/Predictive AI Servo AF)]
- When the AF point which achieved focus in the One-Shot AF mode detects subject movement, the AI Servo AF mode takes over.
- (1)Automatically set in the Full Auto and No Flash modes.
 - (2)In the Basic Zone and Creative Zone modes, the beeper will sound when AI SERVO AF operates during the AI Focus AF mode.
- 2)Manual focus (MF)
- After the lens focus mode is switched to MF, manual focusing is enabled with the focusing ring.
- (1)When focus is achieved, the focus confirmation icon and superimposed display lights up.
 - (2)During automatic AF point selection, all **nine AF points** are activated. During manual AF point selection, the selected AF point is activated.
 - (3)During continuous shooting, electronic ring manual focusing is enabled during the exposure.
- 7-4 **Focusing point selection:**
- 1)Automatic selection
- The camera selects the AF point automatically and focuses the subject.
- (1)One-Shot AF
One of **the nine AF points** is selected automatically to focus the optimum subject.
 - (2)AI SERVO AF
At the start of focusing, the center AF point focuses the subject. AI Servo AF continues even if the subject later moves away from the center AF point to another AF point.
 - (3)Normally, it focuses the closest subject.
 - (4)When the AF point selection is automatic, multiple AF points within the in-focus range will light up.
 - (5)Automatically set in the Basic Zone modes and A-DEP.
- 2)Manual AF point selection
- Focuses with one, user-selected AF point.
- Settable in the Creative Zone modes (except A-DEP).
- 7-5 **AF point selection operation:**
- After pressing the AF point selection button, select the AF point with the cross keys or main dial.
- If C.Fn-1-4 has been set, the AF point can be selected directly with the cross keys while the exposure metering is active. (Press the AF point selection button to set automatic AF point selection, press the SET button to select the center AF point, or press the cross keys to select the top, bottom, left, or right AF point.

7-6	AF point display:	Indicated by superimposed display in the viewfinder and on the LCD monitor .
7-7	AF activation:	AF is activated by pressing the shutter button halfway (SW-1)
7-8	AF operation speed:	Same with the EOS 30D (One shot AF)
7-9	Focus confirmation:	Indicated by superimposed display in viewfinder, focus confirmation light, and beeper. (1)In both the Basic and Creative Zone modes, when the AI Focus AF mode is set and the camera switches to AI Servo AF, the beeper will sound. The beeper will also sound in the Sports mode. (2)In the Creative Zone modes, the beeper will not sound when AI Servo AF is set. (3)No focus confirmation indicator in the AI SERVO AF mode. (4)The focus confirmation beeper can be enabled or disabled with the menu's [Beeper].
7-10	AF precision:	Same as EOS 30D
7-11	AF working range:	EV -0.5 - 18 (at 23°C/73°F and ISO 100, under Canon's testing standards)
7-12	AF-assist beam:	Intermittent firing of built-in flash. (1)Effective range: Approx. 4 m/13.1 ft at center, approx. 3.5 m/11.5 ft at periphery. (2)Conditions for emission: Emitted automatically when necessary under low light (EV 4 or lower at ISO 100), linked to all 9 AF points . →Not emitted in the Landscape, Sports, and Flash OFF modes. →In a Creative Zone mode, emitted automatically when the built-in flash has been popped up manually. →Emission can be disabled/enabled with C.Fn-5. (3)Emission time (1 burst), frequency, times (stops when the focus confirmation signal is detected) Approx. 250 ms or less, approx. 28 Hz, Max. 8 times (4)With external EOS Speedlite The external Speedlite's AF-assist beam is used. →When a speedlite equipped with an AF-assist beam other than the 580EX, 550EX, 430EX, 420EX, and ST-E2, is used, the AF-assist beam will be emitted only when AF point selection is automatic or manually selected at the center. (When a speedlite other than the 580EX, 430EX and 420EX is used, the AF-assist beam may not be emitted depending on AF point selection. Also, the subject may not be properly focused even if the beam is emitted. In that case, focus on the center AF point.)

8. Exposure Control

- 8-1 **Type:** Max. aperture TTL metering with 35-zone SPC with the following selectable modes:
 (1)Evaluative metering (linked to all AF points)
 (2)Partial metering (approx. 9% of viewfinder)
 (3)Center-weighted average metering
 →In the Basic Zone modes, (1) is set automatically. In the Creative Zone modes, (1) to (3) are selectable.
 →Press the left cross key to display [Metering mode].
 →Partial metering cannot be linked to the AF point.
 →The name of the selected metering mode is displayed in the camera settings display on the LCD monitor.
- 8-2 **Exposure modes:** 1)Program AE (shiftable)
 2)Shutter-priority AE
 3)Aperture-priority AE
 4)Depth-of-field AE (A-DEP, non-shiftable)
 5)Full Auto (Program AE, non-shiftable)
 6)Programmed Image Control modes (6)
 (1)The name of the shooting mode selected with the Mode Dial is displayed in the camera settings display on the LCD monitor.
 (2)Portrait, Landscape, Close-up, Sports, Night Portrait, Flash OFF
 7)Manual exposure (including bulb)
 8)E-TTL II autoflash program AE
 • C.Fn-8-0: Evaluative metering, C.Fn-8-1: Averaged metering
- 8-3 **Metering range:** EV 1-20 (at 23°C/73°F with 50 mm f/1.4 lens at ISO 100, under Canon's testing standards)
- 8-4 **Exposure beyond range warning:** Shutter speed and aperture displays blink on the LCD monitor and in the viewfinder.
- 8-5 **Exposure metering:** Activated when shutter button is pressed halfway (SW-1 ON).
 • Metering time: Approx. 4 sec. before exposure and approx. 2 sec. after exposure.

8-6 ISO Speed:

1) Basic Zone modes: Automatically set by the camera

(ISO)

Shooting Mode	AE Shooting		With Built-in Flash	With External Speedlite
	Slower than 1/500 sec.	1/500 sec. or faster		
Full Auto	400	100 - 400	400	400
Portrait	100		400	400
Landscape	100 - 400		—	400
Close-up	400	100 - 400	400	400
Sports	400		—	400
Night Portrait	400	100 - 400	400	400
Flash Off	400	100 - 400	—	—

* In the Basic Zone modes, the ISO speed cannot be set manually.

* During continuous shooting, the ISO speed does not change.

* In the Landscape mode, if the shutter speed (Tv-auto) is faster than 1.25 times the reciprocal of lens focal length, ISO 100 is set.

2) Creative Zone modes: 100, 200, 400, 800, 1600

(1) In Creative Zone modes, the ISO speed cannot be set automatically.

(2) Pressing the top cross key displays [ISO speed].

8-7 Exposure Compensation: 1) Manual exposure compensation

(1) Activation: Settable in Creative Zone modes. (excluding Manual mode)

(2) Bracketing range: Up to ± 2 stops in 1/2- or 1/3-stop increments

(3) Bracketing factor: See the bracketing factor used for the respective shooting mode below.

Shooting Mode	Shutter Speed	Aperture
Program AE	Yes	Yes
Shutter-priority AE	—	Yes
Aperture-priority AE	Yes	—
Depth-of-field AE	Yes	Yes
Manual	Yes	—

(4) Exposure compensation cancellation: Set the compensation amount to 0.

Note: If (1) and (2) are set in combination, the AEB amount will be shifted by the exposure compensation amount.

2) AEB (Auto Exposure Bracketing)

(1) Activation: In Creative Zone modes, settable with the menu screen.

- During AEB: The AEB icon and AEB level on the LCD monitor blinks, and the AE lock icon and AEB level blinks in the viewfinder.

(2) Bracketing range: Up to ± 2 stops in 1/2- or 1/3-stop increments

		(3)Bracketing sequence: Standard exposure, decreased exposure, and increased exposure
		<ul style="list-style-type: none"> • Taken in accordance with the drive mode. • If the self-timer is used, the three bracketed shots will be exposed successively after the self-timer delay. • May be used in combination with WB-BKT. (In this case, nine images will be generated.)
		(4)Bracketing factor: Same as for 1).
		(5)AEB cancellation: Set the AEB amount to 0.
8-8	AE Lock:	<p>1)Auto AE lock</p> <ul style="list-style-type: none"> • In the One-Shot AF mode with evaluative metering, AE lock takes effect when focus is achieved. <p>2)Manual AE lock</p> <p>(1)Enabled with AE lock button. (Pressing the button again renews AE lock.)</p> <p>(2)No AE lock in Basic Zone modes.</p> <p>(3)During evaluative metering, AE lock is applied to the exposure setting obtained by the selected AF point. During center partial or center-weighted average metering, AE lock is applied to the exposure setting obtained by the center AF point.</p> <p>(4)When the built-in flash or an EX-series Speedlite is used, the AE lock button works as an FE lock button.</p>
8-9	Multiple exposures:	Not possible
9. Shutter		
9-1	Type:	Vertical-travel, mechanical, focal-plane shutter with all speeds electronically-controlled
		<ul style="list-style-type: none"> • Mechanical shutter: 1st and 2nd shutter curtains both have dedicated magnet control. (Curtain speed: 2.9 ms/15 mm)
9-2	Shutter speeds:	<p>1/4000 sec. to 30 sec. X-sync at 1/200 sec.</p> <p>(1)Settable in 1/3- and 1/2-stop increments in shutter speed-priority AE and manual modes.</p> <p>(2)If the camera settings are already displayed when the bulb exposure starts, the elapsed exposure time will be displayed on the LCD monitor.</p> <p>(3)Max. bulb exposure: Approx. 2 hours. (When elapsed time is displayed, it is approx. 1.5 hours.)</p>
9-3	Shutter release:	Soft-touch electromagnetic release
9-4	Shutter-release time lag:	<p>1)During SW-1 ON, time lag between SW-2 ON and start of exposure: Approx. 100 ms</p> <p>2)Time lag between simultaneous SW-1/SW-2 ON and start of exposure: Approx. 240 ms</p> <ul style="list-style-type: none"> • With aperture stopdown up to 3.5 stops and excluding AF operation time.

- 9-5 **Noise reduction:** Enabled with C.Fn-02 [Noise reduction] set to [Auto] or [On].
 (1)[Auto]: The noise level is detected automatically and noise reduction is performed.
 (2)[On]: Noise reduction is performed on exposures 1 sec. or longer.
 (3)The noise reduction process will take the same amount of time as the exposure time.
- 9-6 **Self-timer:** 10-sec. delay
 (1)After starting, the self-timer can be canceled by pressing the Drive button.
 (2)With C.Fn-7-1 [Mirror lockup], the self-timer delay is 2-sec.
- 9-7 **Self-timer operation indicator:** 1)Red-eye reduction lamp (blinks for the first 8 sec., then lights for the remaining 2 sec.)
 2)LCD monitor (Shot counter counts down from 10 to 1 in 1-sec. increments.)
 3)Electronic beeper (Beeps at 2 Hz for the first 8 sec., then at 8 Hz for last 2 sec.)
- 9-8 **Camera shake warning:** Warning provided in Full Auto and Basic Zone modes.
 • If the shutter speed (Tv-auto) is 0 to 0.5 stops slower than the reciprocal of the lens focal length \times 1.25, the shutter speed display blinks.

10. Drive

- 10-1 **Drive modes:** ① Single ② Continuous shooting ③ Self-timer/Remote control
 (1)Creative Zone modes: ① - ③ are settable.
 (2)Basic Zone modes: ① or ② set automatically depending on the shooting mode and ③ is settable.
- 10-2 **Continuous shooting:** Depending on the shooting conditions, the image-processing method switches automatically.
 (1)When the recording quality is JPEG, image processing is executed even during continuous shooting.
 (2)With RAW, RAW+JPEG, and WB-BKT, image processing is not executed during continuous shooting.

- 10-3 **Continuous shooting speed:** With Battery Pack NB-2LH (Approx. max. shots/sec.)

One-shot AF / MF		3.0
AI SERVO AF	USM lens	
	Non-USM lens	

*With 1/250 sec. or faster shutter speed at all recording quality modes.

10-4 Maximum burst:

Based on Canon's testing standards with 512MB CF card.

Image-Recording Quality	Maximum Burst (Approx.)
Large/Fine	27
Large/Normal	58
Medium/Fine	47
Medium/Normal	112
Small/Fine	98
Small/Normal	326
RAW	10
RAW+Large/Fine	8

*Based on Canon's testing standards with 512MB high-speed CF card.

*The maximum burst is displayed at the bottom of the viewfinder ("9" is displayed if it is 9 shots or higher, or "8" to "0" are displayed if less than 9). The maximum burst is displayed even when the drive mode is Single or Self-timer. (Note that the max. burst will be displayed even if there is no CF card installed.)

*In the B/W mode, the max. burst will be higher than when you shoot in color.

*When the buffer memory becomes full, shooting will not be possible until at least one image in the internal memory is recorded onto the CF card.

*Menu operations are possible during image processing.

10-5 Battery life:

1) With Battery Pack NB-2LH

Battery	Temperature	Shooting Conditions	
		AE100%	AE50%, FA50%
NB-2LH × 1	At 23°C/73°F	Approx. 500	Approx. 360
	At 0°C/32°F	Approx. 370	Approx. 280

2) With BG-E3+Battery Pack NB-2LH

Battery	Temperature	Shooting Conditions	
		AE100%	AE50%, FA50%
NB-2LH × 1	Same as 1)		
NB-2LH × 2	At 23°C/73°F	Approx. 1000	Approx. 720
	At 0°C/32°F	Approx. 740	Approx. 560

* Shooting conditions: Fully charged battery pack, EF50mm f/1.8 II, image review time 2 sec., Large/Fine image quality, and with MicroDrive 1 GB.

* Complies to CIPA testing standards.

* For details, see the BG-E3 Technical Information.

10-6 Image review:

Image review time right after image capture is settable with the menu's [Review time].

(1) Settable to off, 2 sec., 4 sec., 8 sec., or Hold.

(2) If you press the **DISP** button during image review, you can switch the Info display on or off.

11. Built-in Flash

- 11-1 **Type:** Auto pop-up, retractable, built-in flash in the pentaprism
- 11-2 **Guide No.:** Guide No. 13 (at ISO 100 in meters)
- 11-3 **Recycling time:** Approx. 3 sec.
- 11-4 **Flash-ready indicator:** Flash-ready indicator lights on in viewfinder
 - When the flash recycles, the flash icon and "buSy" are displayed and the shutter release locks.
- 11-5 **Flash coverage:** Up to 17 mm focal length (equivalent to 27 mm in 135 format)
- 11-6 **Flash button:** In Creative Zone modes, the button pops up the flash.
- 11-7 **Firing conditions:**
 - 1) Creative Zone modes: After pop-up, fires at all times.
 - 2) Basic Zone modes (except Landscape, Sports, Flash off): Auto pop-up and firing under low-light and backlit conditions.
- 11-8 **Flash sync speed:** Max. X-sync speed 1/200 sec.
 - (1) In Full Auto, Portrait, Close-up, Program, and A-DEP modes: Set automatically to 1/200 sec. to 1/60 sec.
 - (2) In the Night Portrait mode: Set automatically to 1/200 sec. to 2 sec.
 - (3) In Tv and M modes: Set manually to 1/200 sec. or slower.
 - (4) In Av mode: Set automatically to 1/200 sec. to 30 sec. depending on the aperture setting.

11-9 **Flash aperture:** The flash aperture is set as shown below.

Shooting Mode	Av-set	Av-auto		Remarks
		E-TTL P	Tv-AE	
① Program AE		Yes		
② Shutter-priority AE			Yes	
③ Aperture-priority AE	Yes			
④ Depth-of-field AE		Yes		The result is the same as ①
⑤ Full Auto		Yes		
⑥ Portrait		Yes		
⑦ Close-up		Yes		
⑧ Night Portrait		Yes		f/2.8 restriction for max. aperture
⑨ Manual	Yes			

* In the Landscape, Sports, and Flash OFF modes, the built-in flash will not fire. With an external Speedlite, it will fire in the Landscape and Sports modes (same result as ①).

- 11-10 **Autoflash system:** E-TTL II autoflash
- 11-11 **Flash level control:** Automatic flash output reduction for backlit conditions and daylight flash.

- 11-12 Flash exposure compensation:
- 1) Setting precondition: In Creative Zone modes
 - 2) Compensation amount: Up to ± 2 stops in 1/3- or 1/2-stop increments
 - 3) Cancellation: Set exposure level to 0
 - 4) Up to ± 2 stops in 1/3- or 1/2-stop increments.
 - (1) Flash exposure compensation for built-in flash and Speedlite can be set with the camera.
 - (2) An icon indicates whether the flash exposure compensation was set with the built-in flash or external Speedlite.

11-13 Effective flash range: (m/ft)

ISO	EF-S18-55 mm f/3.5-5.6	
	WIDE: 18 mm	TELE: 55 mm
100	1 - 3.7 / 3.3 - 12.1	1 - 2.3 / 3.3 - 7.5
200	1 - 5.3 / 3.3 - 17.4	1 - 3.3 / 3.3 - 10.8
400	1 - 7.4 / 3.3 - 24.3	1 - 4.6 / 3.3 - 15.1
800	1 - 10.5 / 3.3 - 34.4	1 - 6.6 / 3.3 - 21.7
1600	1 - 14.9 / 3.3 - 48.9	1 - 9.3 / 3.3 - 30.5

- * If the focusing distance is shorter than 1 meter / 3.3 feet and no hood is attached to the lens, the flash will be partially obstructed by the lens barrel.
- * If you use a high ISO speed, short focusing distance, and the maximum aperture, overexposure may result.
- * The maximum range is calculated by dividing the respective ISO speed's nominal Guide No. by the f/number.

- 11-14 Improper FE lock warning: During FE lock, the flash icon blinks.
- 11-15 Sufficient flash indicator: None
- 11-16 Flash-sync timing: 1st-curtain sync
 • With C.Fn-9-1 (Shutter curtain sync.), 2nd-curtain sync is possible.
- 11-17 Flash duration: 1 ms or shorter
- 11-18 Color temperature: Equivalent to daylight
- 11-19 Optical axis space: Lens axis to flash center: 92.0 mm
- 11-20 Power source: Supplied by camera's power source
- 11-21 Red-eye reduction: When the built-in flash pops up, the red-eye reduction lamp lights and then the flash fires.
 (1) Type: Illumination by lamp
 (2) Compatible modes: Operates in all modes except Landscape, Sports, and Flash OFF.
 (3) Setting method: With the menu's [Red-eye On/Off].
 (4) Conditions for illumination: Lights after focus is achieved when the shutter button is pressed halfway (SW-1) in the One-Shot AF mode.
 (In the AI SERVO AF or MF mode, the red-eye reduction lamp lights immediately at SW-1.)

(5)Illumination duration: Lamp lights during SW-1 ON. Light level decreases after 1.5 sec.

(With the self-timer, it lights 2 sec. before shutter release.)

(6)Lamp ON indicator: Exposure level display in viewfinder (dot display disappears for the first 1.5 sec.)

(7)Shutter-release lock: None (Shutter-release priority)

Note: With an external EOS-dedicated Speedlite, the red-eye reduction lamp does not light.

12. External Speedlite

12-1 Flash sync contacts:

Hot shoe: X-sync contacts

(1)Locking pin hole provided to prevent Speedlite slippage.

(2)No PC terminal.

12-2 Flash auto:

Enabled with the camera's Program AE mode

(1)With EX-series Speedlites

Compatible with all Speedlite features.

(2)With Canon A-TTL/TTL autoflash external Speedlites

Works in manual and stroboscopic modes and with external flash.

Does not fire in A-TTL/TTL autoflash modes.

Note 1: Does not work with Speedlites not having manual and stroboscopic modes.

Note 2: Cannot be used with TTL Hot Shoe Adapter (flash does not fire even in the Manual/Stroboscopic flash mode).

(3)With non-Canon flash units:

Note 1: On-camera unit can synchronize at 1/200 sec. or slower.

Note 2: Studio flash can synchronize at 1/60 sec. or slower (testing recommended).

12-3 Flash exposure compensation:

1)Manual setting

(1)Up to ± 2 stops in 1/3- or 1/2-stop increments.

(2)If flash exposure compensation is set with both the camera and Speedlite, the Speedlite's setting will override the camera's setting.

2)FEB (Flash Exposure Bracketing)

(1)Settable with the 580EX, 550EX, MR-14EX or MT-24EX.

(2)During continuous shooting, it stops automatically after three shots.

(3)When the flash fails to recharge fast enough during continuous shooting with FEB, AE shooting takes effect. FEB resumes when the flash is ready.

12-4 Modeling flash:

Enabled with the 580EX, 550EX, 430EX, 420EX, MR-14EX, MT24EX.

• In Creative Zone modes, press the depth-of-field preview button to fire at 70 Hz for 1 sec.

- 12-5 **Wireless flash:** Enabled with the 580EX, 550EX, 430EX, 420EX, MR-14EX, MT24EX, or ST-E2.
 (1)Three-group (A, B, C) slave control, a flash output ratio (A:B) control, FEB, and modeling flash (with flash output ratio) are enabled.
 (2)The 430EX and 420EX can be used as slaves only, and the MR-14EX and MT24EX can be used as the master unit only.

13. LCD Monitor

- 13-1 **Type:** TFT color, liquid-crystal monitor
 13-2 **Screen size:** 2.5 in.
 13-3 **Pixels:** Approx. 230,000 pixels
 13-4 **Coverage:** Approx. 100%
 13-5 **Viewing angle:** Approx. 160° vertically and horizontally
 13-6 **Brightness adjustment:** 7 levels
 • Settable with menu's [LCD brightness].
 • Gray chart displayed along with the image.
 13-7 **Angle adjustment:** None
 13-8 **Protective cover:** None

14. Playback

- 14-1 **Image display format:** 1)Single image
 (1)During the image display, press the **DISP** button to switch among normal (image+basic info), image only (no info) and image info display (information+reduced image)
 (2)Press the left or right cross key to view the previous or next image.
 2)9-image index
 • During the image display, press the **DISP** button to switch between normal (9 images+basic info) and 9 images only (no info)
 3)Magnified zoom
 • During the image display, press the **DISP** button to switch between normal (magnified image+basic info) and magnified image only (no info)
 4)Auto play
 5)Auto review right after shooting
 (1)Except when the menu's [Review time: Off] is set, the last image captured is displayed.
 (2)When **C.Fn-10-1** is set, the image can be magnified in the image display right after shooting.
 14-2 **Display conditions:** Images saved in Design rule for Camera File system format.
 (1)If the image is not in the Design rule for Camera File system format, [?] is displayed on the LCD monitor.
 (2)Also applicable to the index's thumbnail images.

14-3 Information display: 1) Shooting information display (Camera Information)
 Pressing the DISP button displays the following in a menu format:
 Date/time, [Picture Style](#), Color space, WB correction amount/WB-BKT setting, [auto rotate display](#), Auto power-off, [automatic sensor cleaning](#), CF card remaining capacity
 Note: In the Basic Zone modes, items that cannot be set will not be displayed (ISO Auto is displayed).

2) Image info display (Playback INFO)
 When an image is displayed and you press the DISP button, the following information will be displayed together with a reduced image:

File No., Reduced image, Histogram (Brightness/[RGB](#)), Color space, Shooting date/time, ISO speed, Metering mode, Shooting mode, Shutter speed, Aperture, Exposure compensation amount, Flash exposure compensation amount, White balance correction amount, Playback image number/Total images recorded, Protect, Recording quality, White balance, Monochrome, [Image file size](#)

Note 1: When an image taken in RAW+JPEG mode is played back, the JPEG file size is displayed.

Note 2: If a JPEG image not in the Design rule for Camera File system format is selected, [!] is displayed.

Note 3: If an image that cannot be displayed is selected, [?] is displayed.

14-4 Highlight alert: In the single image (Info) display mode, the highlight portions containing no image information will blink.

14-5 Histogram display: 1) Brightness 2) [RGB](#)
 • [Switchable with menu's \[Histogram\]](#).

14-6 Magnify zoom display: With the Magnify button, the image can be magnified from the single image display from approx. 1.5× to 10× in 15 steps.

Magnify	Magnify button
Reduce	Reduce button
Scrolls the magnified view in the up, down, left, and right directions.	Cross keys
View next image	Main Dial (The previous or next image can be viewed while the magnified position remains the same.)

* The magnified view starts at the center of the image.

* When C.Fn-10-1 is set, press the [Print/Share](#) button and [Magnify/Reduce](#) button simultaneously to magnify or reduce the image during the image review right after shooting.

14-7 Index display: Single image display or press the Reduce button for 9-image display

• Press the cross keys to view the images.

- 14-8 Rotated display:**
- 1)Manual
 - With the menu's [Rotate], the image can be rotated clockwise in 90°, 270° and 0°.
 - 2)Auto rotate
 - (1)Settable with the menu's [Auto rotate].
 - (2)When Auto rotate is [On (camera, PC)] and a vertical image is played back in horizontal orientation on the camera or on the computer screen (with compatible applications), the camera rotates the image automatically to the vertical orientation.
 - (3) Image rotation doesn't apply to the image review right after shooting.
 - (4)When Auto rotate is [On (PC)] or [Off], the camera does not rotate the image automatically when it is played back.
- 14-9 Jump:**
- 1)Press the Jump button to switch menu tabs (Shooting 1 & 2, Playback, Set-up 1 & 2) or browse images during image playback.
 - 2)The image-browsing function works during ① Single image display, ② 9-image index display, and ③ Magnified view.
 - (1) In the case of ①, pressing the top or bottom cross key will switch to the Jump mode (1. Jump by 10 images, 2. Jump by 100 images, or 3. Jump by date). Pressing the left or right cross key will browse images according to the 1, 2, or 3 setting.
 - (2)In the case of ①-3., the display will jump to the first image of the specified date.
 - (3)In the case of ②, pressing the left or right cross key will jump to the previous or next 9-image index page.
 - (4)In the case of ③, pressing the left or right cross key will jump by 10 images.
- 14-10 Video output:**
- Compatible with NTSC/PAL, video output terminals
- Select the type with the menu's [Video system]. Use Video Cable VC-100.

15. Protection/Deletion of Recorded Images

- 15-1 Protection:**
- A single image can be protected or unprotected.
- With the menu's [Protect].
- 15-2 Erase:**
- A single image or all images stored in a Compact Flash card can be erased if they are unprotected.
- (1)During playback, press the Erase button ([Erase] [All] will be displayed).
 - (2)Images erase-protected with the camera cannot be erased (except during formatting).

16. Menus

- 16-1 **Description:** 1) Shooting 1 menu: 4 items, 2) Shooting 2 menu: 7 items, 3) Playback menu: 7 items, 4) Set-up 1 menu: 7 items, 5) Set-up 2 menu: 7 items
*The menu tabs are color-coded: Red for 1) and 2), blue for 3), and yellow for 4) and 5).
- 16-2 **LCD monitor language:** Any of the following 15 languages can be selected: English, German, French, Dutch, Danish, Finnish, Italian, Norwegian, Swedish, Spanish, Simplified Chinese, Japanese, Traditional Chinese, Korean and Russian.
- 16-3 **Firmware updating:** Enabled by the user.

17. CP Direct/Bubble Jet Direct

(Hereinafter CP Direct abbreviated as CPD and Bubble Jet Direct as BJD.)

- 17-1 **Configuration:** Camera, CPD/BJD-compatible printer, interface cable IFC-400PCU
• Even while the printing screen is displayed (except during printing), the camera can instantly switch to shooting mode when you press the shutter button halfway (SW-1 ON).
- 17-2 **Operation method:** By operating the camera, the image is printed directly by the BJD/CPD-compatible printer.
- 17-3 **Compatible printers:** CPD-series, BJD-series printers
- 17-4 **Paper sizes:** CPD: Card, L, postcard
BJD: A4, L, 2L, card, postcard (when Japanese is selected)
- 17-5 **Transmission protocol:** Canon-developed protocol
- 17-6 **Data transfer system:** Data transfer from camera to printer
CPD: YMC, BJD: JPEG
• With CPD, image processing is executed by the camera, and with BJD, it is executed by the printer.
- 17-7 **Printable images:** Design rule for Camera File system-compliant JPEG images
• JPEG images in RAW+JPEG images can be printed, but not RAW images.
- 17-8 **Printing system:** 1)Single image printing 2)DPOF batch printing
(1)Both CPD/BJD compatible with 1) and 2).
(2)Printing cancellation: Enabled with 1) and 2). Resumable after cancellation: Enabled with 2).
(3)When CPD is connected, image printing in progress cannot be canceled. The printing of all the remaining images will be canceled. When BJD is connected, the printing is canceled and the paper will be discharged.
(4)If an error occurs, [Stop] or [Resume] (Continue) may appear or only [Stop] may appear depending on the error type.

17-9 Style settings:

- 1)CPD: On-screen settings (single or split screen)
BJD: Paper (L, 2L, postcard, A4, card)
*BJD: If Japanese is not selected as the language, the choices will be Card#1, Card#2, Card#3, LTR, and A4 instead.
- 2)Borders (Borders or borderless)
- 3)Date (ON/OFF)

17-10 Trimming:

Trim horizontally up to 8 steps, vertically up to 5 steps.

Reduce frame	Magnify button
Enlarge frame	Reduce button
Moves the frame up, down, left, or right	Cross keys
Rotate frame	DISP button

- (1)Trimming is not possible with DPOF-specified images printed directly.
- (2)The trimming frame will initially appear at the center of the image.
- (3)The trimming aspect ratio will depend on the style setting.
- (4)If the trimming has been set and then the style is changed, the [Readjust trimming] message will appear.
- (5)If the trimmed image is magnified too much and the image becomes rough, the trimming frame will change from green to red.
- (6)When the trimming frame is first displayed or when there is no operation for 5 sec., the guidance icon will appear. The guidance icon disappears during an operation and only the trimming frame is displayed.
- (7)When operation is done with a TV set via the video output, the trimming frame might not be displayed properly.

17-11 Direct Print:

With camera's [Print/Share button](#)

- (1)When the camera is connected to a printer and you press the playback button, the [Print/Share button](#) lamp lights in blue. After you select the image and press the Print/Share button, the printing starts. During the printing, the lamp blinks in blue.
- (2)On the image playback screen, the Direct Printing icon and the print settings (paper size, borders, date, etc.) are displayed.
- (3)If a BJD printer is connected, you need to check if the paper size is properly set. (If a CPD printer is connected, this is not required as the size of paper installed is recognized automatically.)
- (4)To change the print settings, press the SET button before printing. (Same procedure as normal direct printing.)

18. PictBridge

- 18-1 Configuration: Camera, CPD/BJD printer, interface cable IFC-400PCU
 • Even while the printing screen is displayed (except during printing), the camera can instantly switch to shooting mode when you press the shutter button halfway (SW-1 ON).
- 18-2 Operation method: By operating the camera, the image is printed directly by the PictBridge-compatible printer.
- 18-3 Compatible printers: PictBridge-compatible printers
- 18-4 Paper sizes: 9×13 cm*, 13×18 cm*, 10×14.8 cm*, CreditCard (5.4×8.6 cm), 4"×6"*, 5"×7"*, 8.5"×11"*, A4*, 11"×17"*, A3*, A3+/13×19*, roll paper (9 cm/4" /13 cm/21 cm), 8.9×25.4 cm (panorama), 4"×8"*, 10"×12"*, 8"×10"*, 14"×17"*
 (1)Selectable paper sizes may differ depending on the printer.
 (2)Papers with a "*" mark enable shooting information to be printed as well.
 (Applicable only to Canon printers compatible with this feature.)
 (3)Names of paper sizes may differ depending on the language (Japanese, English, etc.).
- 18-5 Paper types: Plain, Photo (Photo Paper Plus Glossy), Fast Photo (Photo Paper Pro), Fine Art (Fine Art paper, photo rag), Semi-glossy (Super Photo paper, silky), Default (Photo Paper Plus Glossy)
 (1)Canon paper names (in Japan) are in parentheses above.
 (2)Selectable paper types may differ depending on the printer.
- 18-6 Printing effects (Image optimization): 1)With Canon printers:
 Natural, Natural M, B/W, Cool tone, Warm tone, ON (Exif print), Off (no printing effects), VIVID, NR (noise reduction), VIVID-NR, Default (Exif print)
 (1)Selectable printer effects may differ depending on the printer.

(2)If the JUMP button is pressed when selecting printing effects, printing adjustments are available as shown in the table below.

	Off	On/Vivid	Natural	Natural M	B/W / Cool tone / Warm tone
Brightness	-3 - 0 - +3	-3 - 0 - +3	-3 - 0 - +3	-3 - 0 - +3	-3 - 0 - +3
Adjust levels	Off	Auto	Auto	Off / Auto / Manual	Off / Auto / Manual
 Brightener	Off/On	Off/On	Off/On	Off/On	Off/On
Red-eye corr.	Off/On	Off/On	Off/On	Off/On	Off/On
Detail set.	Contrast	0	0	0	-3 - 0 - +3
	Saturation	0	0	0	-3 - 0 - +3
	Color tone	0	0	0	-3 - 0 - +3
	Color balance	0, 0	0, 0	0, 0	B/A, M/G: ±9

* Settings in gray cells are displayed, but cannot be changed.

* If [Clear all] is selected, settings will be [Brightness]: 0, [Adjust levels /  Brightener / Red-eye corr.]: Off, [Contrast / Saturation / Color tone]: 0, and [Color balance]: 0, 0.

* The  Brightener and Red-eye correction are done by the printer.

2)With non-Canon printers:

ON, OFF, Default

(1)The settings for ON/Default are set by the printer manufacturer.

(2)Selectable printer effects may differ depending on the printer.

18-7 Trimming:

Trim horizontally up to 16 steps, vertically up to 10 steps.

• The trimming method will depend on the CPD/BJD printer.

18-8 Layout:

Borders, borderless, 2/4/8/9/16/20/35-image layout (duplicate images on one sheet), print+shooting information, 20-image index+shooting information, 35-image contact sheet index, standard setting (borderless with Canon printers)

(1)Selectable layouts may differ depending on the printer.

(2)In the case of 20-image index+shooting information and 35-image contact sheet index, images specified with DPOF will be printed. Selectable when A4 or 8.5×11" (Letter) is set (possible only with Canon printers compatible with this feature).

(3)Print+shooting information can be set only when the paper size is 9×13cm or larger (possible only with Canon printers compatible with this feature.)

- 18-9 Date and file No. imprinting: Date, file No., Both, Off, Default setting (set to Off by Canon printers).
 • If the printer cannot imprint the date, the date will not be imprinted even if this feature is enabled.
- 18-10 DPOF-compatible: DPOF print ordering possible
 (1)If both Standard and Index have been set, only Standard will take effect for the printing.
 (2)Even if file number imprinting is enabled, it will not be imprinted. (BJ printers are not compatible with file number imprinting.)
- 18-11 Transmission protocol: PTP
- 18-12 Data transfer system: JPEG
- 18-13 Printable images: Design rule for Camera File system-compliant JPEG images
 • JPEG images in RAW+JPEG images can be printed, but not RAW images.
- 18-14 Direct Print: With camera's Print/Share button
 (1)When the camera is connected to a printer and you press the playback button, the Print/Share button lamp lights in blue. After you select the image and press the Print/Share button, the printing starts. During the printing, the lamp blinks in blue.
 (2)On the image playback screen, the Direct Printing icon and the print settings (paper size, borders, date, etc.) are displayed.
 (3)To change the print settings, press the SET button before printing. (Same procedure as normal direct printing.)

19. Print specification (DPOF)

- 19-1 System: Complies to DPOF Version 1.1
- 19-2 Specification with print screen:
 1)Individual images
 2)All images in CF card
 • Print specification is not possible for RAW images.
- 19-3 Print type:
 1)Standard
 2)Index
 3)Both
- 19-4 Date/File No. print:

Print type		CPD		BJD		PictBridge	
		Date	File No.	Date	File No.	Date	File No.
Standard		Yes	Yes	Yes	No	△	△
Index		Yes	Yes	No	No	△	△
Both	Standard	Yes	Yes	Yes	No	△	△
	Index	Yes	Yes	No	No	△	△

* For index prints, both the date and file No. cannot be set to [ON].
 * For index prints with BJD, the date or file No. will not be imprinted even if it is set to [ON].
 * Whether using PictBridge is possible or not depends on the printer.

- 19-5 **Camera direct:** With a CPD/BJD printer or PictBridge printer connected, batch printing of specified images is possible.
- Printed after the paper size and borders on/off are specified.

20. Direct Image Transfer

- 20-1 **Configuration:** Camera, PC (Windows / Macintosh), interface cable IFC-400PCU
- Even while the direct image transfer screen is displayed (except during actual image transfer), the camera can instantly switch to shooting mode when you press the shutter button halfway (SW-1 ON).
- 20-2 **Compatible PC:** Windows and Macintosh computers with EOS DIGITAL Solution Disk Ver. 1.2 installed.
- ① Connect the camera to the PC, ② Select [EOS Utility] in the event dialog that appears on the PC, ③ Transfer an image.
 - ② If it's set to use [EOS Utility] all the time, step ② is not necessary.
- 20-3 **Transmission protocol:** PTP
- 20-4 **Transferable images:** JPEG / RAW images
- If images were taken in RAW+JPEG mode, RAW and JPEG images are transferred to the PC.
- 20-5 **Image transfer:** Images are transferred to PC when the SET button or Print/Share button is pressed.
- (1) All images
 - All images stored in a CF card are transferred to the PC.
 - (2) All images not yet transferred
 - Only images that haven't been transferred to the PC are automatically selected for transfer.
 - (3) Images marked for transfer
 - Images designated in the menu's [Transfer order] are transferred to the PC. In [Transfer order], you can choose either [Order] for individual images or [All] for all images. Procedures for marking images for transfer are the same as for marking individual images for DPOF.
 - Up to 998 images can be marked.
 - (4) Select image and transfer
 - Select images to transfer, and transfer them to the PC.
 - (5) Wallpaper for computer
 - Select an image to use as the background (wallpaper) for the computer screen, and transfer it to the PC.
 - A JPEG image is automatically converted into a BMP image to be transferred, and appears as the background (wallpaper) for the computer screen.
 - RAW images cannot be transferred.

21. Customization

21-1 Custom Functions: [11 Custom Functions with 29 settings](#) settable with the camera.

22. External Interface

22-1 Digital terminal: USB 2.0 Hi-Speed, mini B port
 22-2 Video output terminal: Provided (NTSC/PAL)
 22-3 Remote control terminal: Compatible with Remote Switch RS-60E3 (2.5 mm dia. mini-jack)
 22-4 Wireless remote control
 1)Compatible with Remote Controller RC-1 and RC-5
 2)Wireless remote control receiver built-in inside the camera grip.
 (1)Compatible shooting modes: All
 (2)Operation setting: When the Drive mode button is pressed, the self-timer/ wireless remote control timer icon is displayed on the [LCD monitor](#).
 (3)Operation range: Within approx. 5 m/16.4 ft. (at front and center)
 (4)Operation indicator: (RC-1: Shutter release after 2 sec. and when RC-5 is used.) Same as last 2 sec. of self-timer indicator.

23. Power Source

23-1 Battery: Battery Pack MB-2LH × 1
 (1)With the AC Adapter Kit ACK700, AC power is possible.
 (2)With BG-E3, two battery packs can be used. Or six size-AA batteries can be used.
 23-2 Main switch: Two settings: OFF/ON
 • Power turns off if the CF card slot cover or battery compartment cover is opened.
 23-3 Start-up time: Approx. 0.2 sec.
 23-4 Battery check: Automatic battery check when the main switch is turned on. The battery level is indicated by one of [four levels](#) on [the LCD monitor](#).
 23-5 Power-saving feature (Auto power off): Power turns off after the set time of non-operation elapses.
 • Select from the menu's [Auto power off] the time: [30 sec.](#), 1, 2, 4, 8, 15 min, or off.
 23-6 Date/time back-up battery: 1)Lithium CR2016 button battery × 1
 2)Battery life approx. 5 years
 (1)No backup battery warning.
 (2)Date/time is reset when the battery is replaced.

24. Body (Chassis) Material	Stainless steel and polycarbonate with glass fiber
25. Exterior	
25-1 Exterior material:	ABS resin, polycarbonate resin, polycarbonate resin with special conductive fiber
25-2 Exterior color:	Titanium silver or satin black
25-3 Tripod socket:	CU 1/4
26. Dimensions	126.5 (W) × 94.2 (H) × 65 (D) mm 4.98 (W) × 3.71 (H) × 2.56 (D) in.
27. Weight	510 g / 18 oz. (1)Excludes battery pack, CF card, and body cap. (2)Includes backup battery and eyecup.
28. Operating Environment	
28-1 Operating temperature:	0°C to 40°C / 32 to 104°F
28-2 Operating humidity:	85% or less
29. Accessories	
29-1 Grip:	Battery Grip BG-E3 • For details, see the BG-E3 Technical Information.
29-2 Battery Pack:	Battery Pack NB-2LH Battery: Lithium-ion Rated voltage: 7.4 V DC Rated capacity: Approx. 720 mAh Recharging time: Approx. 90 min. Operating temperature: 0°C to 40°C / 32 to 104°F Dimensions: 33.3 (W) × 16.2 (H) × 45.2 (D) mm 1.31 (W) × 0.64 (H) × 1.78 (D) in. Weight: 43 g / 1.52 oz.
29-3 Battery Charger:	Battery Charger CB-2LW, CB-2LT, CB-2LTE
29-4 AC power:	AC Adapter Kit ACK-DC20/ACK700 • Compact Power Adapter CA-PS700, DC Coupler DR-700, and power cable provided.
29-5 Interface cable:	Interface Cable IFC-400PCU
29-6 Video cable:	Video Cable VC-100
29-7 Case:	Semi-hard Case EH18-L
29-8 Strap:	Wide Strap EW-100DBII
29-9 EOS System Accessories:	See the System Accessory Compatibility Table.

4. NOMENCLATURE (FEATURES DIFFERENT FROM THE EOS KISS DIGITAL N ARE INDICATED IN BLUE.)

4.1 Nomenclature

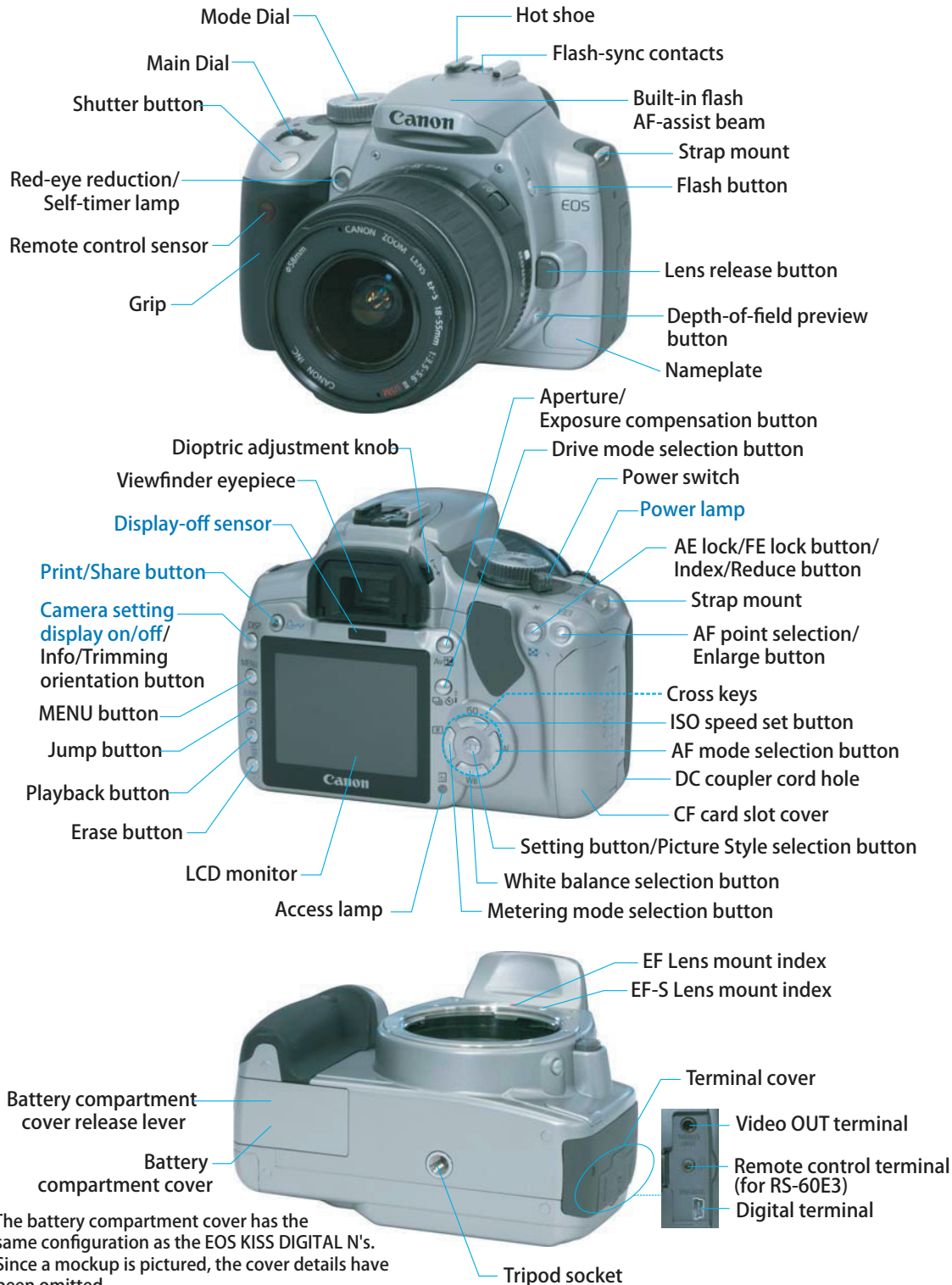

*The battery compartment cover has the same configuration as the EOS KISS DIGITAL N's. Since a mockup is pictured, the cover details have been omitted.

Fig. 024 Nomenclature

4.2 Dimensions

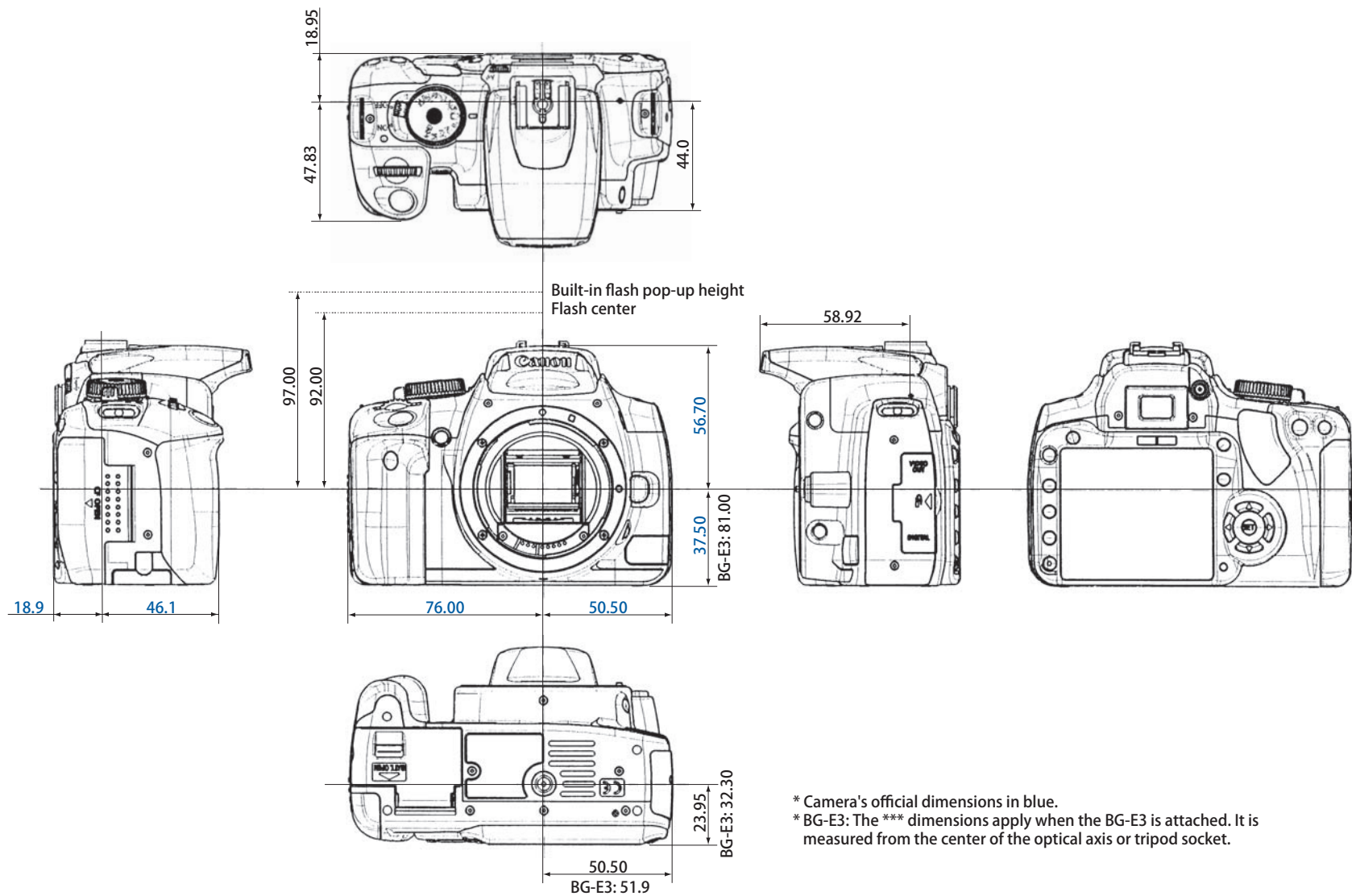

Fig. 025 Six Exterior Views

5. VISUAL INDICATORS

5.1 Viewfinder Information

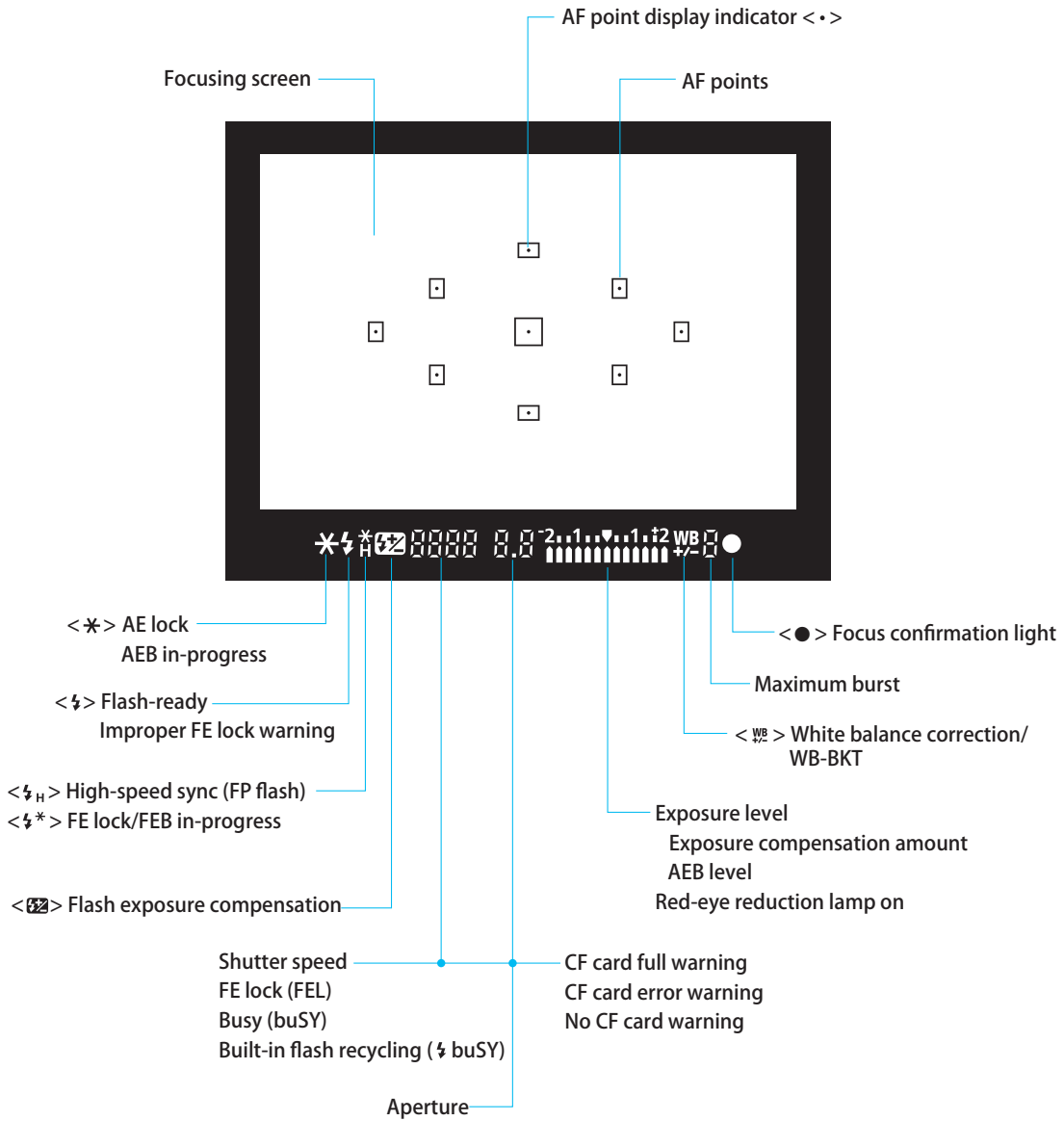

Fig. 026 Viewfinder Information

5.2 LCD Panel Information and Model Dial

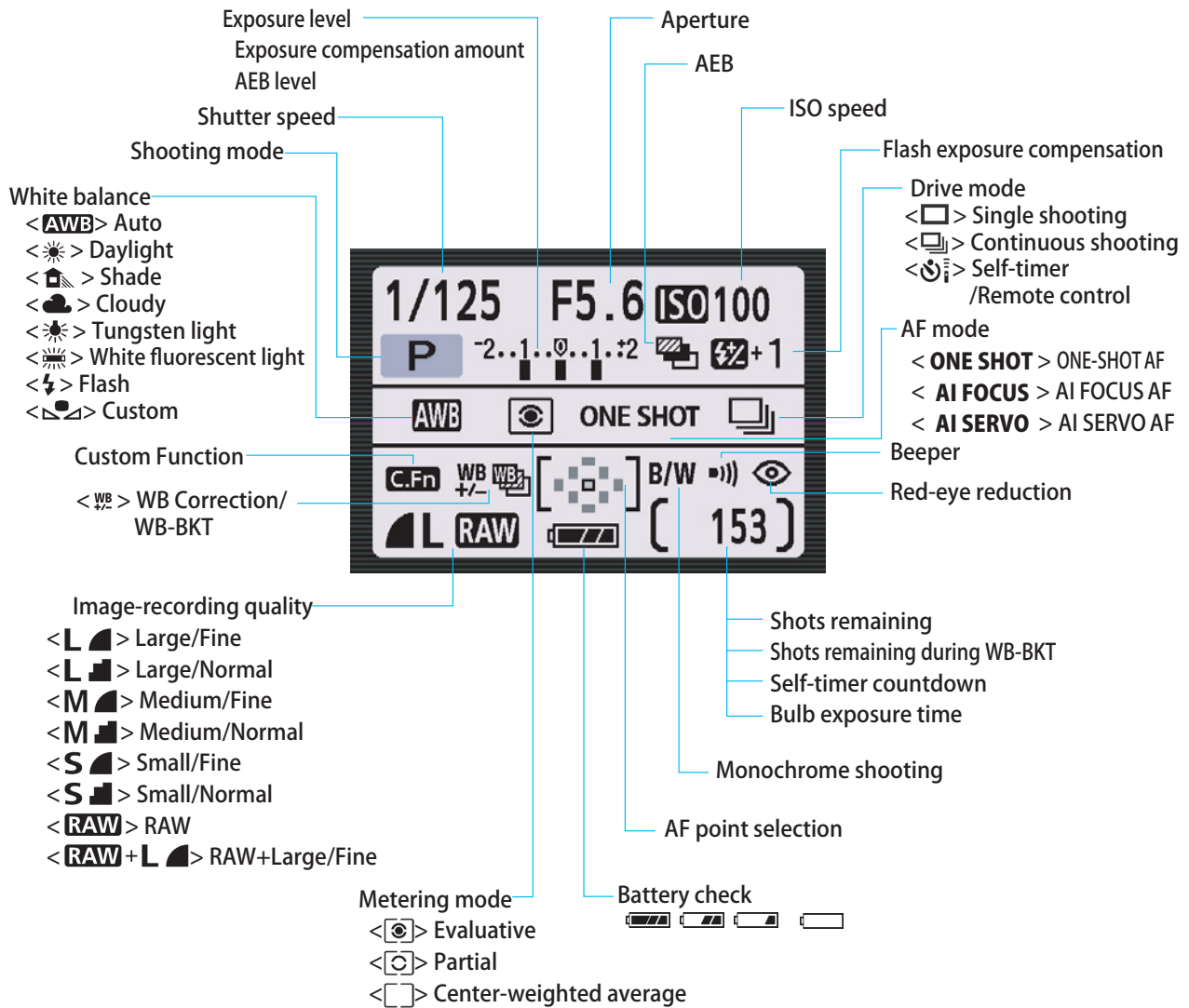

Fig. 027 Camera setting display on LCD monitor

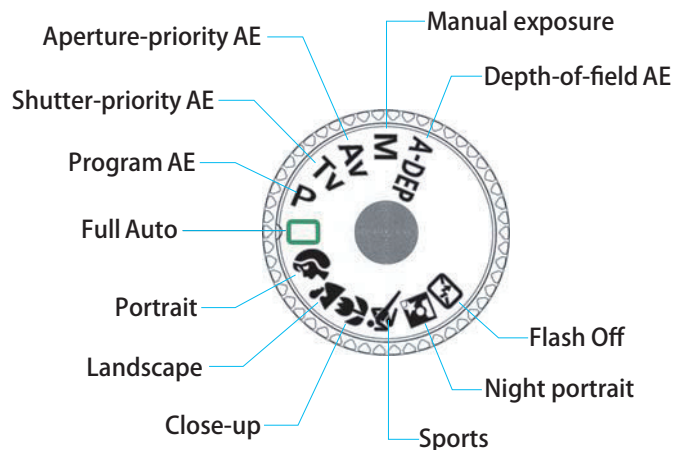

Fig. 28 Mode Dial

Table 005 Shooting Mode Feature Availability

Shooting mode	AF					Drive			Metering			AEL	Exp. Comp.		Built-in Flash				External	FEL		
	ONE SHOT	AI SERVO	AI FOCUS	AF Point Selection		AF-assist beam										Auto	Manual	Flash OFF				Red-eye
① Full Auto			●	●		●	●		○	●					●			○	○			
② Portrait	●			●		●		●	○	●					●			○	○			
③ Landscape	●			●			●		○	●							●		○	○		
④ Close-up	●			●		●	●		○	●					●			○	○			
⑤ Sports		●		●				●	○	●							●		○	○		
⑥ Night Portrait	●			●		●	●		○	●					●			○	○			
⑦ Flash OFF			●	●			●		○	●							●					
⑧ Standard Program AE	○	○	○	○	○	○	○	○	○	○	○	○	○	○		○		○	○	○	○	○
⑨ Shutter-priority AE	○	○	○	○	○	○	○	○	○	○	○	○	○	○		○		○	○	○	○	○
⑩ Aperture-priority AE	○	○	○	○	○	○	○	○	○	○	○	○	○	○		○		○	○	○	○	○
⑪ Manual	○	○	○	○	○	○	○	○	○	○	○	○	○	○		○		○	○	○	○	○
⑫ Depth-of-field AE	●	—	—	●		○	○	○	○	○	○	○	○	○		○		○	○	○	○	○

Shooting mode	Picture Style				Image-Recording Quality			ISO Speed		White Balance				Color Space			
	Standard	Selectable			JPEG	RAW	RAW+	Auto	Manual		Selectable	MWB		WB-BKT	sRGB		
① Full Auto	●				○			●		●					●		○
② Portrait			●		○			●		●					●		○
③ Landscape				●	○			●		●					●		○
④ Close-up	●				○			●		●					●		○
⑤ Sports	●				○			●		●					●		○
⑥ Night Portrait	●				○			●		●					●		○
⑦ Flash OFF	●				○			●		●					●		○
⑧ Standard Program AE	○	○	○	○	○	○	○		○	○	○	○	○	○	○	○	○
⑨ Shutter-priority AE	○	○	○	○	○	○	○		○	○	○	○	○	○	○	○	○
⑩ Aperture-priority AE	○	○	○	○	○	○	○		○	○	○	○	○	○	○	○	○
⑪ Manual	○	○	○	○	○	○	○		○	○	○	○	○	○	○	○	○
⑫ Depth-of-field AE	○	○	○	○	○	○	○		○	○	○	○	○	○	○	○	○

● : Automatically set.

○ : Selectable, settable, or functional.

— : Selectable but not functional.

*When AI SERVO AF is set in a Creative Zone mode, the beeper will not sound.























5.3 Functional display screens

		EOS D REBEL XTI / EOS 400D D	EOS KISS DIGITAL N
Shooting (Red)	1	 <p>Quality L Red-eye On/Off Off Beep On Shoot w/o card On</p>	 <p>Quality L Red-eye On/Off Off Beep On AF mode ONE SHOT Metering mode [M] ISO speed 100</p>
	2	 <p>AEB -2..1..0..1..2 Flash exp comp -2..1..0..1..2 WB SHIFT/BKT 0, 0/±0 Custom WB Color space sRGB Picture Style Standard Dust Delete Data</p>	 <p>AEB -2..1..0..1..2* Flash exp comp -2..1..0..1..2* White balance [W] WB SHIFT/BKT 0, 0/±0 Custom WB Color space sRGB Parameters Parameter 1</p>
Playback (Blue)		 <p>Protect Rotate Print order Transfer order Auto play Review time 2 sec. Histogram Brightness</p>	 <p>Protect Rotate Print order Auto play Review time 2 sec.</p>
Setup (Yellow)	1	 <p>Auto power off 30 sec. Auto rotate On [A] LCD brightness [L] LCD auto off Enable Date/Time 08/01/06 15:40 File numbering Continuous Format</p>	 <p>Auto power off 1 min. Auto rotate On LCD brightness [L] Date/Time 02/21/06 17:32 File numbering Continuous Format Shoot w/o card On</p>
	2	 <p>Language English Video system NTSC Custom Functions(C. Fn) Clear settings Sensor cleaning : Auto Sensor cleaning : Manual Firmware Ver. 1.0.0</p>	 <p>Language English Video system NTSC Communication Print/PTP Custom Functions(C. Fn) Clear settings Sensor cleaning Firmware Ver. 1.0.0</p>
Custom Function		 <p>Custom Function [01] [A] SET button/Cross keys funct. 0:SET:Picture Style 01 02 03 04 05 06 07 08 09 10 11 0 0 0 0 0 0 0 0 0 0</p>	 <p>Custom Function [01] [A] SET button/Cross keys funct. 0:Normal 01 02 03 04 05 06 07 08 09 0 0 0 0 0 0 0 0 0</p>

Fig. 029 EOS D REBEL XTI / EOS 400D D and EOS KISS DIGITAL N Menu Comparison

5.4 LCD Monitor Menus

1) Shooting Menu

Color	Basic	Creative	Item	Description	
Shooting 1 Commands	△	○	Quality	(→ Setting screen)	
				 	 
				 	 
				 	 
				 	 
	○	○	Red-eye On/Off	Off	
				On	
	○	○	Beep	On	
				Off	
	○	○	Shoot w/o card	On	
Off					

* In the Basic Zone modes, the RAW and RAW+JPEG recording modes are not displayed.

Fig. 030 Menu Functions (Shooting 1)

Color	Basic	Creative	Item	Description			
Shooting 2 Commands	×	○	AEB	0, ±1/3, ±2/3, ±1, ±1_1/3, ±1_2/3, ±2 (C.Fn-6-0) 0, ±1/2, ±1, ±1_1/2, ±2 (C.Fn-6-1)			
	×	○	Flash exp comp	0, ±1/3, ±2/3, ±1, ±1_1/3, ±1_2/3, ±2 (C.Fn-6-0) 0, ±1/2, ±1, ±1_1/2, ±2 (C.Fn-6-1)			
	×	○	WB SHIFT/BKT	(→ Setting screen)	WB correction: B: 9-0-A: 9, M: 9-0-G: 9 WB-BKT setting: B/A or M/G bias. 0, ±1, ±2, ±3		
	×	○	Custom WB	(→ Image selection screen/SET button: Set)			
	×	○	Color space	sRGB			
				Adobe RGB			
					Standard	Sharpness	0, 1, 2, 3, 4, 5, 6, 7
					Portrait	Contrast	-4, -3, -2, -1, 0, +1, +2, +3, +4
					Landscape	Saturation	-4, -3, -2, -1, 0, +1, +2, +3, +4
					Neutral	Color tone	-4, -3, -2, -1, 0, +1, +2, +3, +4
				Faithful			
×	○	Picture Style	(→ Picture Style selection screen)	Monochrome	Sharpness Contrast Filter effect Toning effect	0, 1, 2, 3, 4, 5, 6, 7 -4, -3, -2, -1, 0, +1, +2, +3, +4 N:None/Ye:Yellow/Or:Orange/ R:Red/G:Green N:None/S:Sepia/B:Blue/P:Purple/ G:Green	
				User Def. 1 - 3	A Picture Style is selected to modify and register it.		
×	○	Dust Delete Data	OK	(→ Setting screen)			
			Cancel				

* In the Basic Zone modes, the Shooting 2 menu is not displayed.

Fig. 031 Menu Functions (Shooting 2)

2) Playback Menu

Color	Basic	Creative	Item	Description		
Playback Commands	<input type="radio"/>	<input type="radio"/>	Protect	(\rightarrow Image selection screen/SET button: Protect, cancel)		
	<input type="radio"/>	<input type="radio"/>	Rotate	(\rightarrow Image selection screen/SET button: 90°\rightarrow270°\rightarrow0°)		
	<input type="radio"/>	<input type="radio"/>	Print order	(\rightarrowPrint setting screen)	Order	(\rightarrow Image selection screen, quantity setting)
	Set up	Print Type			Standard/Index/Both	
		Date			On/Off	
		File No.			On/Off	
	All	Mark all				
	Print	Clear all				
	<input type="radio"/>	<input type="radio"/>	Transfer order	(\rightarrow Setting screen)	Order	(\rightarrow Image selection screen / Setting)
					All	Mark all
					Clear all	
	<input type="radio"/>	<input type="radio"/>	Auto play	(\rightarrow Autoplay screen/SET button: Playback, Pause)		
	<input type="radio"/>	<input type="radio"/>	Review time	Off		
				2 sec.		
4 sec.						
8 sec.						
			Hold			
<input type="radio"/>	<input type="radio"/>	Histogram	Brightness			
			RGB			

Fig. 032 Menu Functions (Playback)

3) Set-up Menu



Color	Basic	Creative	Item	Description
Set-up 1 Commands	<input type="radio"/>	<input type="radio"/>	Auto power off	30 sec.
				1 min.
				2 min.
				4 min.
				8 min.
				15 min.
				Off
	<input type="radio"/>	<input type="radio"/>	Auto rotate	On  
				On 
				Off
<input type="radio"/>	<input type="radio"/>	LCD brightness	(→ Setting screen/7 levels with Quick Control Dial, image and gray chart also displayed)	
<input type="radio"/>	<input type="radio"/>	LCD auto off	Enable	
			Disable	
<input type="radio"/>	<input type="radio"/>	Date/Time	(→ Setting screen) yy/mm/dd, mm/dd/yy, dd/mm/yy	
<input type="radio"/>	<input type="radio"/>	File numbering	Continuous	
			Auto reset	
			Manual reset	
<input type="radio"/>	<input type="radio"/>	Format	(→ CF card formatting screen/Cancel/OK)	

Fig. 033 Menu Functions (Setup 1)

Color	Basic	Creative	Item	Description			
Set-up 2 Commands	○	○	Language	(→ Setting screen)	English (English)	Suomi (Finnish)	Русский (Russian)
					Deutsch (German)	Italiano (Italian)	简体中文 (Simplified Chinese)
					Français (French)	Norsk (Norwegian)	繁体中文 (Traditional Chinese)
					Nederlands (Dutch)	Svenska (Swedish)	한국어 (Korean)
					Dansk (Danish)	Español (Spanish)	日本語 (Japanese)
	○	○	Video system	NTSC			
				PAL			
	×	○	Custom Functions(C.Fn)	(→ Setting screen/C.Fn-01 to 11)			
	×	○	Clear settings	(→ Setting screen)	Clear all camera settings	Cancel/OK	
					Clear all Custom Functions	Cancel/OK	
				Clean now			
○	○	Sensor cleaning : Auto	(→ Setting screen)	Clean when the power switch is turned <ON> or <OFF>.	Enable		
					Disable		
×	○	Sensor cleaning : Manual	(→ Sensor cleaning screen/Cancel/OK)				
×	○	Firmware Ver. *	(→ Firmware update screen/Cancel/OK)				

* Factory defaults:
 For Japan: Japanese/NTSC/Year, month, day
 For N. America: English/NTSC/Month, day, year
 Other regions: English/PAL/Day, month, year

Fig. 034 Menu Functions (Setup 2)

6. CUSTOM FUNCTIONS

6.1 Custom Function List

Table 006 Custom Functions

C.Fn	Item	No.	Setting
1	SET button/Cross keys funct.	0	SET:Picture Style
		1	SET:Quality
		2	SET:Flash exp comp
		3	SET:Playback
		4	Cross keys:AF frame selec.
2	Long exp. noise reduction	0	Off
		1	Auto
		2	On
3	Flash sync. speed in Av mode	0	Auto
		1	1/200sec. (fixed)
4	Shutter/AE lock button	0	AF/AE lock
		1	AE lock/AF
		2	AF/AF lock, no AE lock
		3	AE/AF, no AE lock
5	AF-assist beam	0	Emits
		1	Does not emit
		2	Only external flash emits
6	Exposure level increments	0	1/3-stop
		1	1/2-stop
7	Mirror lockup	0	Disable
		1	Enable
8	E-TTL II	0	Evaluative
		1	Average
9	Shutter curtain sync.	0	1st-curtain sync.
		1	2nd-curtain sync.
10	Magnified view	0	Image playback only
		1	Image review and playback
11	LCD display when power ON	0	Display
		1	Retain power OFF status

*C.Fn-1: Assigns the function to the SET button or to the cross keys for shooting.

7. PROGRAM DIAGRAMS

7.1 Program Diagrams

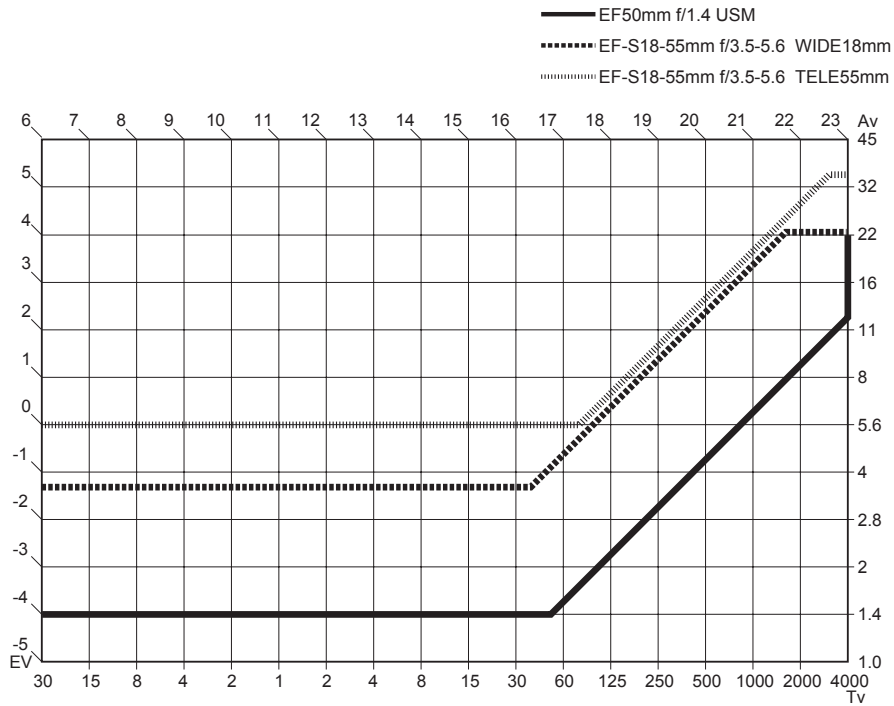

Fig. 035 Normal Program AE Lines

7.2 E-TTL II autoflash program line

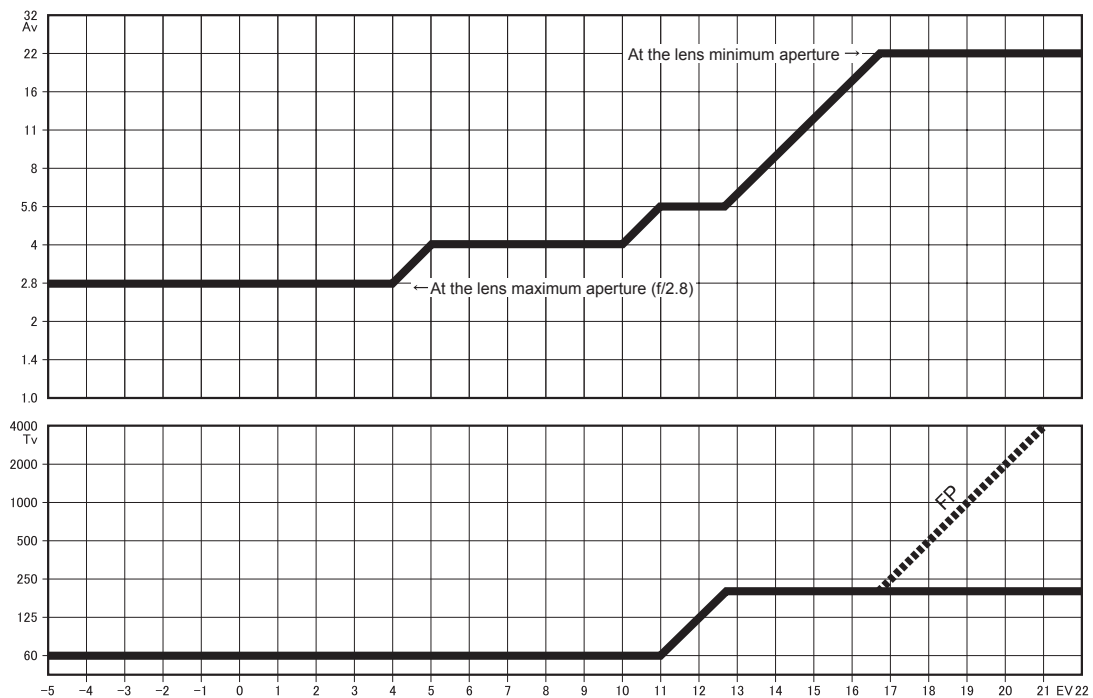

Fig. 026 E-TTL II autoflash program line (EF50mm f/1.4 USM, at ISO 100)

8. SYSTEM ACCESSORIES COMPATIBILITY TABLES

8.1 System Accessories

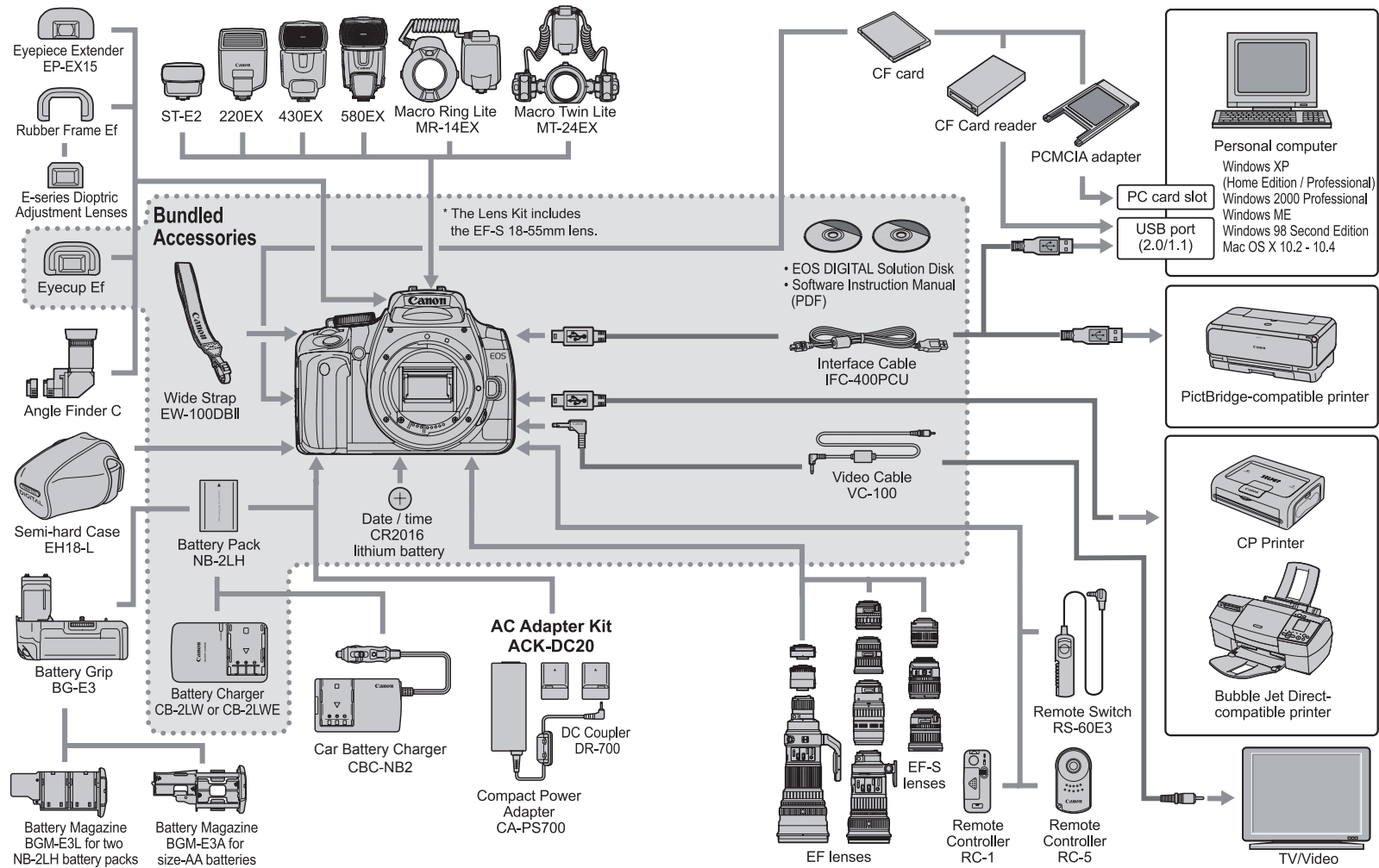

Fig. 037 System map

8.2. System Accessory Compatibility

Note that the following system accessories have some restrictions when used with the EOS D REBEL XTI / EOS 400D D.

Table 007 Accessories with Restrictions

Interchangeable Lenses	
Lens Mount Converter FD-EOS	Although it can be used with manual exposure, exposure error occurs. Therefore, these items will be officially listed as incompatible.
Macro Lens Mount Converter FD-EOS	
Speedlites	
480EG	Not compatible
540EZ	Compatible with manual flash (does not fire in A-TTL/ TTL autoflash modes).
430EZ	
420EZ	
ML-3	Not compatible (since it only has autoflash modes, it cannot fire).
300EZ	
200E	
Wired multi-Speedlite accessories	Not compatible (since it cannot fire in Manual flash mode when used with TTL hot shoe adapter).

System accessories not listed above are completely compatible with the EOS D REBEL XTI / EOS 400D D.

9. OPERATION CAUTIONS

9.1 Agreed Answers for User Support

Cautions	Remarks
[Imaging sensor]	
1. When cleaning the CMOS sensor, use only a hand blower to blow off dust, etc. Never touch the CMOS surface with any brush, cloth, or cleaning agent. Also do not use pressurized (canned) air or gas to clean the CMOS sensor.	This is to prevent damage to the sensor.
2. If there is a strong light source within the image area, ghosting might occur at a symmetrical position or near the light source.	As per the design of low-pass filter.
[Image Recording and Playback]	
3. While the access lamp is blinking, do not shake or subject the camera to any physical shock and do not open the Compact Flash card slot cover or remove the battery.	Doing so may damage the stored images, Compact Flash card, or even the camera itself.
4. Do not leave or use the camera near a strong magnetic field such as a television, audio speaker, or magnet.	A magnetic or electromagnetic field can adversely affect the image on the LCD monitor. It may also prevent proper shooting and image recording and damage images in the Compact Flash card.
5. Do not leave or use the camera near an electronic transmission tower, etc., which emits a strong magnetic field.	The electric wave can adversely affect the image on the LCD monitor. It may also prevent proper shooting and image recording and damage images in the Compact Flash card.
6. If a high ISO speed is set, fewer images can be captured.	As per the design. (The LCD panel will show the remaining shots which varies depending on the ISO speed.)
7. When an image captured with Adobe RGB is displayed on the LCD monitor or TV set, displayed in an sRGB environment, or printed by an sRGB printer, the image will have low color saturation.	This occurs because the color space is not suitable. (Compared to sRGB, Adobe RGB's color reproduction range is wider. If the image is displayed via sRGB without profile conversion, the color reproduction range becomes narrow.) (To obtain accurate reproduction of Adobe RGB in an sRGB environment, use image-editing software like Adobe Photoshop to convert the profile to sRGB.)
[White balance]	
8. When WB-BKT is set, the shots remaining will decrease to about one-third of the normal quantity.	With WB-BKT, each shot yields three images. The number of shooting times remaining is displayed when WB-BKT is set.
[AF]	
9. With the EF70-200mm f/2.8L USM attached with an Extender, use the center AF point to focus.	Although focusing is possible with all 9 AF points, the focusing precision can be guaranteed only with the center AF point.
10. If you use the AI SERVO AF mode with flash, the AF-assist beam will not be emitted by the camera or external Speedlite.	Since AF-assist beam does not match predictive AF very well. ONE-SHOT AF is recommended for flash photography.

Cautions	Remarks
[Flash]	
11. With EOS-dedicated Speedlites other than the EX-series, autoflash is not possible.	This camera it does not have a flash exposure sensor compatible with A-TTL/TTL. (The flash will not fire in the A-TTL/TTL autoflash mode. Use the manual flash mode instead. EOS-dedicated Speedlites not having a manual flash mode and wired, multi-Speedlite accessories cannot be used.)
12. When using the Landscape or Sports mode, do not use an EOS-dedicated, external Speedlite.	The flash would fire at all times and the photo might not come out as you desire.
13. When using the built-in flash, detach any lens hood from the lens.	This is to prevent flash coverage cut-off.
14. Do not connect a high-voltage flash unit to the hot shoe.	It may not fire.
[Custom Functions]	
15. With C.Fn-7-1 (mirror lockup) set, do not point the camera toward the sun or any bright light source.	Doing so can damage the shutter curtains, cause stray light to enter, or damage the imaging sensor.
[Camera Direct]	
16. When printing via BJ Direct with borders enabled and date imprinted, the date is imprinted on the border.	The problem lies with the BJ printer. Does not occur with CP printers. (BJ Direct is set to imprint the date within the image area of an image having a 4:3 ratio produced by a PowerShot camera. So printing an EOS digital camera's 3:2 ratio image having a shorter vertical dimension will make the date fall on the border. The same problem occurs with DPOF.)
17. When printing via CP Direct with the date imprinted, the imprinted date looks light if the image background is light or if it falls on the border.	The problem lies with the CP printer.
[Interface]	
18. Do not excessively bend or disassemble the interfaceable.	Malfunction may result due to cable disconnection or short-circuiting.
19. Before displaying captured images on a TV monitor, check whether it uses the NTSC or PAL system.	If the TV monitor uses a different system, the images will not be displayed properly. (The default setting is NTSC for the Japan and N. America, and PAL for other countries.)
20. When the EOS D REBEL XTi / EOS 400D D is connected to a TV set and the pictures are displayed, part of the image is hidden.	Caused by the TV screen display design.
[LCD Monitor]	
21. When the LCD monitor is on, there might be black, red, or green dots that are always visible.	These are dead pixels which number 0.02% or less of the LCD monitor's total number of effective pixels. The recorded images are not affected.
22. Do not press on the LCD monitor with your fingers or subject it to strong vibration or physical shock.	Doing so may result uneven color or break of the LCD monitor.
[Camera & Misc.]	
23. There is a small noise when the camera is shaken.	This is the sound of the ball in the camera orientation detection unit.

Technical Information

Trademarks

The product names and company names described in this Service Manual are the registered trademarks of the individual companies.

Copyright

Canon Inc. retains the copyright to this Service Manual. Reproduction, publication (including on the World Wide Web), alteration, translation into another language, or other use of the data in whole or part, contained on this Service Manual without the written consent of Canon Inc. is prohibited.

CONTENTS

	Page
Technical Information	
1. Technical Description	1
1.1 Image sensor • CMOS sensor	1
1.2 Image recording and processing	3
1.3 Dust reduction feature	5
1.4 AF system	8
1.5 Viewfinder	11
1.6 Exposure control	11
1.7 Drive	12
1.8 Built-in flash	13
1.9 LCD monitor and basic operation concept	14
1.10 Camera direct printing/Print order (DPOF)	16
1.11 Direct image transfer	16
1.12 Power source	16
1.13 Internal construction	17

1. TECHNICAL DESCRIPTION

1.1 Image sensor • CMOS sensor

1) Overview

The large CMOS sensor (Fig. 001) developed and manufactured by Canon has enabled the camera to attain the top overall performance in its class. It features high resolution (approx. 10.10 effective megapixels), wide ISO speed range (ISO 100-1600), and low noise.

Table 001 CMOS sensor specifications

Specification	EOS D REBEL XTI / EOS 400D D	EOS KISS DIGITAL N
Effective pixels [approx.]	3904×2598 (Approx. 10.10 million)	3472×2312 (Approx. 8.00 million)
Total pixels [approx.]	3996×2622 (Approx. 10.50 million)	3520×2328 (Approx. 8.20 million)
Effective sensor size [mm]	22.2×14.8	
Pixel size [μm]	5.7	6.4
Color filter	RGB primary color filter	
Aspect ratio	3 : 2	

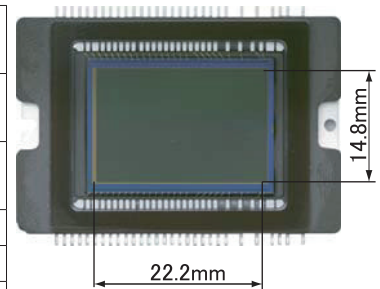

Fig. 001 CMOS sensor

2) Wide-range ISO speed and low noise

Thanks to the following new technologies, the ISO speed range is the same as the EOS KISS DIGITAL N's even with the pixel size of $5.7 \mu\text{m}$ square. (Table 002)

Table 002 CMOS sensor specifications

Camera	ISO Speed	Pixel Size [μm]
EOS D REBEL XTI / EOS 400D D	100 - 1600	5.7
EOS KISS DIGITAL N	100 - 1600	6.4
EOS 30D	100 - 1600 • 3200	6.4
EOS-1D Mark II N	50 • 100 - 1600 • 3200	8.2
EOS-1Ds Mark II	50 • 100 - 1600 • 3200	7.2

(1)At high ISO speed

The spacing between the on-chip microlenses is now about half that of the EOS KISS DIGITAL N. This improves the light convergence. Also, by optimizing the output amplifier, low noise is attained. And as with the EOS KISS DIGITAL N, the second-generation, on-chip, noise-reduction circuit minimizes random noise and removes fixed-pattern noise. As a result, the same S/N ratio and ISO 1600 as with the EOS KISS DIGITAL N are attained.

(2)At low ISO speed

With finer processing and optimized photo diode construction, the photo diode is able to accumulate a good amount of light. The dynamic range at the low ISO speed is on par with the EOS KISS DIGITAL N's dynamic range attaining an equivalent of ISO 100.

3) Faster speed

With the two-channel, high-speed clock reading and improved performance of the output amp, signal reading is faster with low noise. The continuous shooting speed of 3 fps is the same as the EOS KISS DIGITAL N's.

4) Energy saving

To minimize the increased power consumption due to the high-speed reading, the output amp's power consumption was absolutely minimized. Also, during long exposures, power to the output amp is cut off and the standard current for the circuit drive is also cut off as with the EOS KISS DIGITAL N.

5) Infrared-blocking, low-pass filter

The construction of the infrared-blocking, low-pass filter is as shown in Fig. 002.

With the EOS D REBEL XTI / EOS 400D D, low-pass filter 1 is part of the Self Cleaning Sensor Unit.

(1)Low-pass filter 1

This separates the subject image into two images horizontally. The front of the filter is coated with a dichroic mirror to reflect infrared light.

(2)Phase plate

The images separated by low-pass filter 1 are converted from linear polarization to circular polarization. The phase plate is for preparing the polarized components, enabling low-pass filter 2 to correctly separate the subject image into four square images.

(3)Infrared-absorption glass

Together with the dichroic mirror coated on the front of the low-pass filter, this infrared-absorption glass has a hybrid construction to reflect and absorb infrared light. Red ghosting and color casts caused by reflections on the sensor surface, etc., are effectively suppressed by the infrared-blocking filter.

(4)Low-pass filter 2

The subject image separated into two images horizontally by the low-pass filter is separated vertically into two images by this low-pass filter 2. The image is thereby properly separated into four square images. The image separation width for the vertical and horizontal images is optimized for the sensor pitch. This minimizes color artifacts caused by minute horizontal- and vertical-line patterns.

As with the EOS 5D, low-pass filter 2 also serves as the CMOS sensor package's cover glass. This eliminates having a relatively expensive glass cover and reduces the cost.

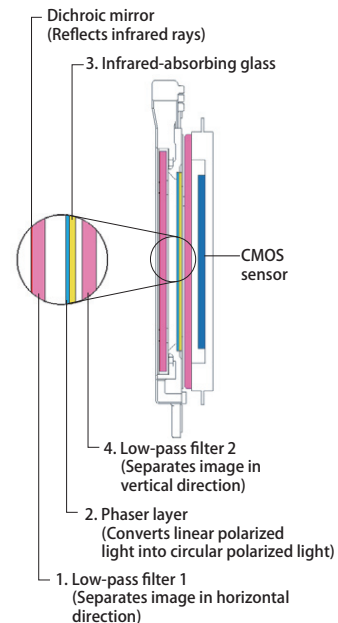

Fig. 002 Cross section of infrared cut, low-pass filter

1.2 Image recording and processing

As with the EOS KISS DIGITAL N, image processing is done by DIGIC II and the startup time is approx. 0.2 sec. RAW+JPEG simultaneous recording, conformance to Design rule for Camera File System Version 2.0/Exif Version 2.21, the color space, and the white balance are also the same as with the EOS KISS DIGITAL N. However, the specifications of the recording quality, noise reduction, folder and file numbering have been improved with the EOS D REBEL XTi / EOS 400D D. Specifications of the Picture Styles and image-creation characteristics are the same as with the EOS 5D and EOS 30D.



Fig. 003 Image-recording quality selection screen

1) Recording quality and file size

Table 003 Recording Quality and File Size

Image-recording Quality		Pixels [Approx.]	Image Type	Compression Rate	Single Image Size [Approx. MB]	Possible Shots [Approx.]	Printing Size
Large	Fine	3888×2592 (10.10 megapixels)	JPEG	Low compression	3.8	130	A3 or larger
	Normal			High compression	2.0	249	
Medium	Fine	2816×1880 (5.30 megapixels)		Low compression	2.3	216	A5 - A4
	Normal			High compression	1.2	410	
Small	Fine	1936×1288 (2.50 megapixels)		Low compression	1.3	376	A5 or smaller
	Normal			High compression	0.7	709	
RAW		3888×2592 (10.10 megapixels)	RAW	RAW: Lossless	9.8	50	A3 or larger
RAW+Large/Fine		—	RAW + JPEG	Compression	—	36	

* The number of possible shots is based on Canon's testing standards and 512MB CF card.

* The single image size and number of possible shots will vary depending on the subject, shooting mode, ISO speed, Picture Style, etc.

* With B/W shooting, the single image size is smaller.

2) Noise reduction feature

As with the EOS 5D and EOS 30D, Custom Function C.Fn-02 [Long exp. noise reduction] can be set to [Auto] or [On].

[1: Auto]

If the exposure time is 1 sec. or longer, detection of noise caused by the long exposure or high air temperature (spots or red fringing at image corners) is performed. Noise reduction is performed only if noise is detected.

[2: On]

Noise reduction is always performed for images shot with an exposure time of 1 sec. or longer. This is effective for the noise that rarely occurs even in a low-temperature environment (when such noise cannot be detected automatically).

*In the case of both the [Auto] and [On] settings, noise reduction will be performed as described above regardless of the ISO speed setting.

*Shooting is not possible during the noise reduction process.

3) Image recording to CF card

(1)Writing to CF card

The same high-speed data writing as the EOS KISS DIGITAL N is attained.

(2)Folder and file numbering

As with the EOS 30D, one folder can now contain up to 9999 images. Also, the [File numbering] menu now has the [Manual reset] option to manually reset the file numbering and create a new folder. Thus, the images can be better organized. For example, pictures taken today can be stored in a different folder from the folder containing pictures taken yesterday. Note that the folder cannot be user-selected.

1.3 Dust reduction feature

1) Overview

Digital SLRs having interchangeable lenses are susceptible to dust entering the camera when the lens is changed. The dust can then adhere to the imaging sensor and show up as dust spots on the images. A feature to remove dust on the sensor has been most desirable. The EOS D REBEL XTi / EOS 400D D incorporates a three-step, dust-reduction feature to effectively remove dust spots from images.

(1) Self Cleaning Sensor Unit

Dust adhering to low-pass filter 1 in front of the imaging sensor is shaken off. (Fig. 004)

(2) Dust Delete Data acquisition and appending

The Dust Delete Data is obtained and appended to the image to enable the software to erase the dust spots automatically.

(3) Manual cleaning of imaging sensor

With mirror lockup, you can clean the sensor manually.

Based on the Self Cleaning Sensor Unit and Dust Delete Data acquisition and appending feature, the overall strategy of not generating, not attracting, and not leaving dust is pursued as follows:

● Not generating dust

- The shutter unit (same as EOS KISS DIGITAL N) generates minimal dust.
- The body cap is now made of a material which minimizes dust caused by normal wear and rubbing. (Incorporated since the first half of 2005.)

● Not attracting dust

- The low-pass filter is treated with an anti-static charge process to prevent static-charged dust from adhering to it.

● Not leaving dust

- Self Cleaning Sensor Unit.
- Dust Delete Data acquisition and appending.

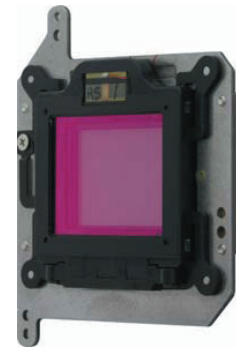

Fig. 004 Self Cleaning Sensor Unit

2) Self Cleaning Sensor Unit

Prior to developing this unit, we analyzed the causes of visible dust and their types and sizes. The dust becomes most noticeable at small apertures. We studied what sizes of dust were the worst offenders at small apertures. The Self Cleaning Sensor Unit was then developed to effectively eliminate those types of dust.

(1) Unit configuration

Low-pass filter 1 on the front of the sensor is attached to an ultrasonic vibrating unit driven by a piezoelectric element. By subjecting low-pass filter 1 to ultrasonic vibrations, the adhering dust is shaken off the surface (Fig. 005). The removed dust then sticks to an absorbent material* ringing the low-pass filter 1. This unit also has an internal O-ring around the

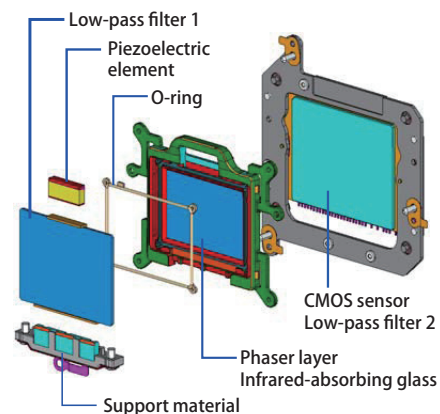

Fig. 005 Unit configuration

perimeter to keep out dust.

* Absorbent material: This is industrial-grade, double-sided tape. It does not lose its stickiness even after a lot of dust adheres to it.

Also, compared to a rival manufacturer's dust-removal system which uses a vibrating glass, the EOS D REBEL XTi / EOS 400D D uses low-pass filter 1 which vibrates directly to shake off dust. Therefore, the optical performance is not degraded by an extra sheet of glass, and compactness is maintained. The camera body size is still the same as the EOS KISS DIGITAL N.

(2) Unit operation timing

① Auto

The default setting has the self-cleaning unit operating for 1 sec. when the camera's power switch is turned on or off. During the self-cleaning operation, the LCD monitor displays the self-cleaning system logo. (Fig. 006 and 007)

② Manual

The self-cleaning system can also be activated manually with the menu. Note that shooting priority still takes effect. If you press the shutter button halfway or press the menu button during the self-cleaning operation (in either the Auto or Manual modes), the cleaning operation will stop and the camera will be ready to shoot.

③ Off

If you use the Dust Delete Data feature and do not want to change the data of the dust coordinates, you can disable the self-cleaning operation so it does not operate when the power is turned on or off.

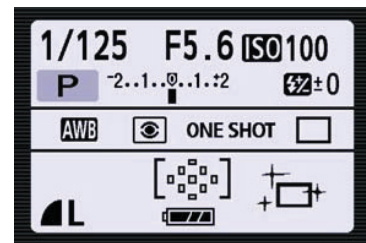

Fig. 006 Power on screen

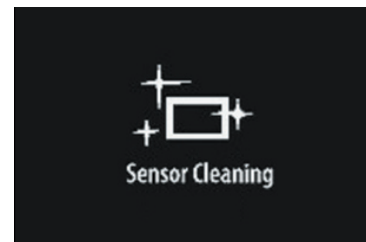

Fig. 007 Power off screen

(3) Power consumption

Since the self-cleaning system is powered by an extremely low amount of power, it hardly affects the number of possible shots with the battery.

● Disabling the self-cleaning unit

To prevent the piezoelectric element from overheating, the self-cleaning unit cannot operate for 3 sec. after any operation. Also, if the self-cleaning unit is operated five consecutive times within 10 sec., it will not work for 10 sec. afterward.

While the self-cleaning unit is disabled, if you select [Sensor cleaning: Auto], the [Clean now] option will be grayed out and cannot be selected. (Fig. 008)

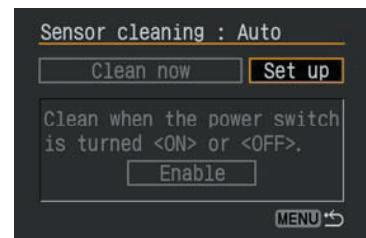

Fig. 008 [Clean now] when cleaning is disabled

3) Dust Delete Data

In case the Self Cleaning Sensor Unit cannot remove all the dust, the Dust Delete Data is obtained and appended to the image so that DPP Ver. 2.2 can erase the remaining dust spots on the image automatically.

(1) Obtaining and appending Dust Delete Data

The shadows created by the dust particles adhering to low-pass filter 1 are detected by the imaging sensor. The most troubling dust particles are then singled out and their location coordinates are obtained as Dust Delete Data. This data is appended to the image. (Fig. 009) After the shutter is released, it takes about 6 sec. to obtain the Dust Delete Data.

To obtain the Dust Delete Data, you have to take a picture so that the shadows of the dust particles show up easily in the image. Note that in the following cases, the Dust Delete Data cannot be obtained properly. A message telling you to try again will appear on the screen. (Fig. 010)

- The picture was overexposed or underexposed by 2 stops or more.
- The lighting of the white paper is very uneven.
 - * Any common light source is fine.

The Dust Delete Data obtained is appended to the both JPEG and RAW images regardless of the shooting mode. The Dust Delete Data is only a few kilobytes, so it will not affect the continuous shooting speed, maximum burst, etc.

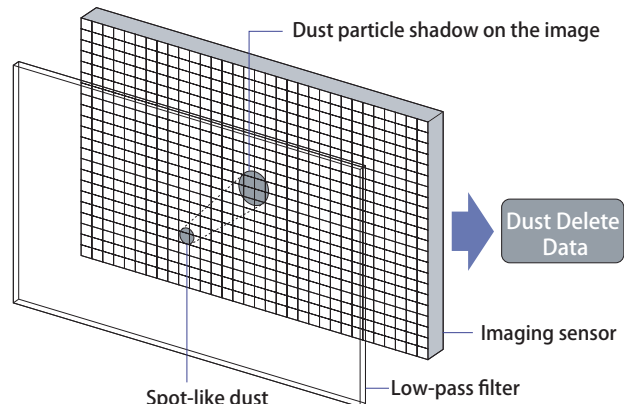

Fig. 009 Obtaining Dust Delete Data

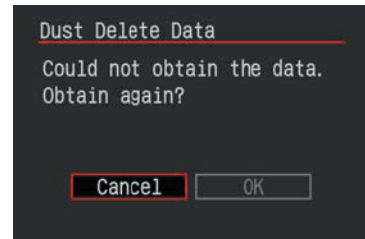

Fig. 010 Retry screen to obtain Dust Delete Data

(2)Automatic erasure by Digital Photo Professional (DPP)

DPP Ver. 2.1 had the copy stamp tool for manually selecting and erasing round dust spots. This feature has been improved with the DPP Ver. 2.2 which can use the Dust Delete Data to erase the dust spots automatically.

With an image appended with Dust Delete Data, the automatic dust spot erasing process activates and erases dust spots by starting the copy stamp tool and pressing the [Auto fix (tentative name)] button. (Fig. 011) With DPP Ver. 2.2, the dust spots at the locations specified by the Dust Delete Data are detected and erased if doing so is deemed effective.

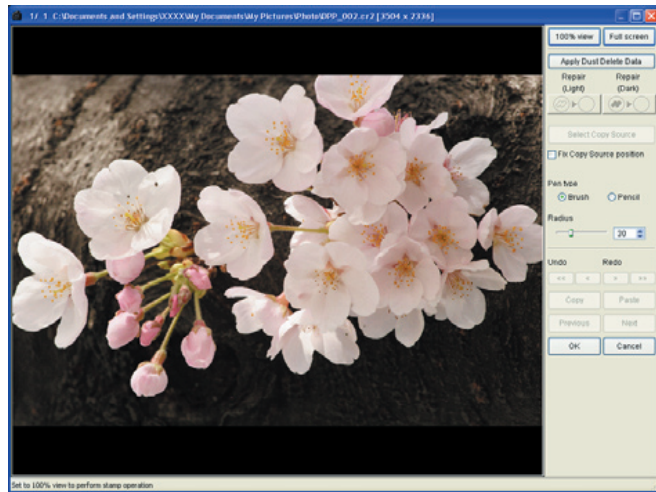

Fig. 011 DPP dust-erasing screen

1.4 AF system

1) AF unit and AF sensor

The camera has the same 9-point AF sensor (Fig. 012) and AF unit as the EOS 30D. The EOS D REBEL XTi / EOS 400D D is the first entry-level EOS Digital camera to have a cross-type, center AF point compatible with f/2.8. Also, since the AF system is the same as the EOS 30D's, the EOS D REBEL XTi / EOS 400D D has the following AF performance improvements over the EOS KISS DIGITAL N. The EOS D REBEL XTi / EOS 400D D has the same wide-area focusing as the EOS 30D (Fig. 013).

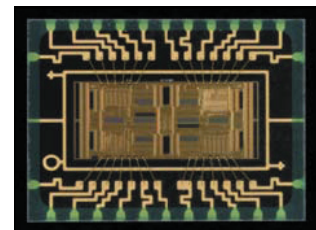

Fig. 012 AF sensor

(1)Improved AF detection precision

- Vertical-line sensitive sensor for f/2.8 at the center

With an f/2.8 or brighter lens, the center AF point detects the focus with the f/2.8 light flux. The base line of the center AF point's vertical-line sensitive sensor is twice as long as an AF point compatible with f/5.6. This makes focusing detection more sensitive.

The center AF point also has a vertical-line sensitive sensor compatible with f/5.6. Therefore, cross-type focusing is possible with any EF lens.*

* Exceptions are the EF50mm f/2.5 MACRO and EF28-80mm f/2.8-4L USM lenses.

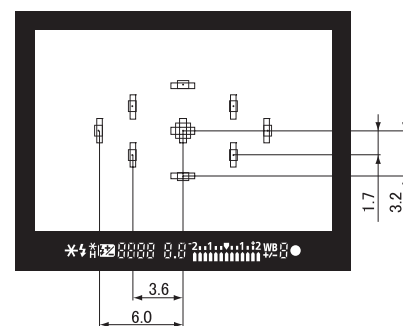

Fig. 013 Focusing area

- **Two-line focusing with the center AF point's horizontal-line sensitive sensor at f/5.6**
The center AF point's horizontal-line sensitive sensor for f/5.6 has a two-line, zigzag pattern. By having redundant focusing, the focusing detection becomes more consistent.

- **Improved AF precision with fine-tuning**
As with the EOS 30D, fine-tuning has been incorporated to improve the AF precision.

(2)Improved performance under low light

The focusing performance under low light has been improved by 1 stop. Focusing is now possible within EV -0.5 to EV 18.

(3)Wider focusing area

- Diagonal configuration of AF points (in and around the prime area (golden section)).
- Improved subject focus tracking with nine AF points.

2) AF speed and calculation

As with the EOS 30D, a high-performance, 32-bit RISC microcomputer is used for high-speed processing. It executes preceding AF processing, and the SI display and focusing at the same time as the lens driving and reflex mirror action. The AF speed is therefore on par with the EOS 30D.

The algorithm for AI SERVO AF continuous shooting has been fine-tuned and optimized to attain 3 fps.

3) AF mode

In the Creative Zone modes, the following AF modes can be selected: One-Shot AF, AI Focus AF, and AI SERVO AF (Fig. 014). In the Basic Zone modes, the optimum AF mode is selected automatically.

In the Sports, Flash Off, and Basic Zone's Full Auto modes, the beeper sounds softly (with the beeper enabled) while focus is achieved with AI SERVO AF.

*In the Creative Zone modes with AI SERVO AF, the beeper does not sound while focus is achieved.

*The AF mode can be set even while the lens focus mode switch is set to MF. However, "MF" will be displayed on the LCD monitor when it displays the camera settings.



Fig. 014 AF mode selection screen

4) AI SERVO AF

(1) Predictive AF

With an EF300mm f/2.8L IS USM lens, the camera can focus-track a moving subject approaching at 50 kph up to about 10 meters/32.8 feet away.

The predictive AF calculation is the same as with the EOS KISS DIGITAL N.

(2) Still subjects

As with the EOS 30D, the lens drive keeps still when focusing a still subject with AI SERVO AF. If the subject begins to move, the camera can begin to focus-track the subject immediately since the focus detection is conducted continuously.

(3) Pressing the shutter button suddenly

As with the EOS 30D, if you press the shutter button completely in one quick stroke (no halfway pressing), the lens will focus, if possible, before the picture is taken. If focusing is not possible, the picture will be taken anyway to give priority to taking the picture.

5) Automatic AF point selection

With the same algorithm used by the EOS 30D, a high probability of selecting the desired AF point automatically is attained.

6) Manual AF point selection

The selection procedure is the same as with the EOS KISS DIGITAL N. With the EOS D REBEL XTI / EOS 400D D, you can select the AF point on the LCD monitor's large display (Fig. 015).

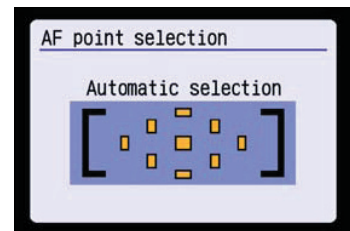

Fig. 015 AF point selection screen

7) AF-assist beam

As with the EOS KISS DIGITAL N, the AF-assist beam is a series of stroboscopic flashes. The working range is approx. 4 meters/13.1 feet at the center and approx. 3.5 meters/11.5 feet at the other 8 AF points.

Table 004 AF-assist beam with External Speedlites

Speedlite	Automatic Selection	Manual Selection			
		Center	Top/Bottom	Left/Right	Mid-left/Mid-right
580EX	○	○	○	○	○
550EX	○	○	×	○	○
430EX	○	○	○	○	○
420EX	○	○	○	○	○
380EX	○*	○	×	×	×
220EX	○*	○	×	×	×
ST-E2	○	○	×	○	○

* Focus can be achieved only with the center AF point.

1.5 Viewfinder

The viewfinder optics (0.80× magnification, 95% coverage, 21mm eyepoint, dioptic adjustment range -3.0 to +1.0 dpt), focusing screen (Precision Matte), and viewfinder blackout time (170 ms) are the same as the EOS KISS DIGITAL N's.

1) Superimposed display

The camera uses the same basic configuration as the EOS KISS DIGITAL N for its superimposed display optics. The SI display is provided for all nine AF points.

1.6 Exposure control

1) Exposure metering

The camera uses the same evaluative metering and E-TTL II algorithm as the EOS 30D with nine AF points. Three metering modes are provided: Evaluative metering, partial metering at center (approx. 9% of viewfinder area), and center-weighted average metering.

2) Exposure control modes

As with the EOS KISS DIGITAL N, eleven AE modes and a manual exposure mode are provided.

3) Shutter

The shutter unit has the same basic configuration* as the EOS KISS DIGITAL N's shutter unit. For bulb exposures, the maximum battery life with a fully-charged NB-2LH battery is approx. 2 hours (When elapsed time is displayed, it is approx. 1.5 hours.)

*To accommodate the Self Cleaning Sensor Unit space-wise, a very slight design modification has been incorporated.

4) ISO speed

The ISO speed setting range (ISO 100-1600 in whole-stop increments) and ISO Auto (Table 005) are the same as with the EOS KISS DIGITAL N.

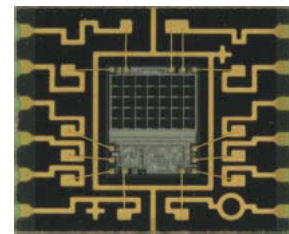

Fig. 016 Metering sensor

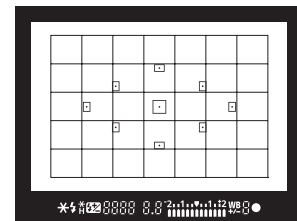

Fig. 017 Metering zones

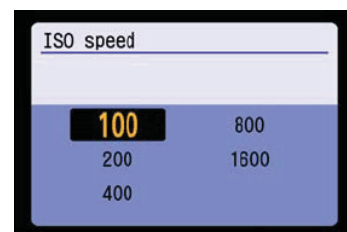

Fig. 018 ISO speed setting screen

Table 005 Automatic ISO Speed Settings

	No Flash	W/built-in flash	W/external Speedlite
	100 - 400	400	400
	100	400	400
	100 - 400	—	400
	100 - 400	400	400
	400	—	400
	100 - 400	400	400
	100 - 400	—	400

1.7 Drive

1) Continuous shooting speed

The maximum continuous shooting speed is approx. 3 fps (in both the One-Shot AF and AI SERVO AF modes). This is achieved by a number of features: The reflex mirror drive and shutter drive are controlled independently, the CMOS sensor enabling high-speed signal reading, and DIGIC II enabling high-speed image processing.



Fig. 019 Drive mode setting screen

2) Maximum burst during continuous shooting

The maximum burst in Large/Fine mode is approx. 27 shots for JPEG and 10 shots for RAW (twice as many as with the EOS KISS DIGITAL N) (Table 006). Also, with white balance bracketing, up 6 shots can be taken continuously (only 2 shots with the EOS KISS DIGITAL N).

Table 006 Maximum burst during continuous shooting

Recording Quality	L/F	L/N	M/F	M/N	S/F	S/N	RAW	RAW+L/F
Max. Burst [Approx.]	27	58	47	112	98	326	10	8

* The figures above are based on Canon's testing standards with a 512MB CF card. (The figures can also vary depending on the CF card.)

* As with the EOS KISS DIGITAL N, image processing occurs even during continuous shooting. This increases the maximum burst.

* During white balance bracketing, the maximum burst during continuous shooting will be lower.

3) Number of possible shots

Table 007 shows the minimum and maximum figures for the number of possible shots are measured in simulated actual shooting conditions while complying the CIPA (Camera & Imaging Products Association) testing standards.

Table 007 Battery Life [Approx. number of shots]

Temperature	Shooting Conditions	
	AE100%	AE50% FA50%
At 23°C /73°F	500	360
At 0°C / 32°F	370	280

* Based on one fully-charged NB-2LH battery and CIPA testing standards.

Using any of the following features can conserve battery power:

(1) Auto power-off now set to 30 sec.

With the EOS KISS DIGITAL N, the shortest power-off time was 1 min. The default setting for auto power-off is now 30 sec. This is to conserve more power and increase the number of possible shots (Fig. 020).

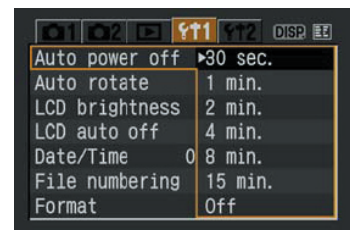

Fig. 020 Auto power-off setting screen

(2) LCD monitor On/Off with <DISP.> button

Since the LCD monitor can now be turned off/on with the <DISP.> button, battery power can be saved even if auto power-off has been disabled or set to a long time period. You can display the camera settings only when needed. To make it easier to press the <DISP.> button, it is positioned at the top of the column of digital-operation buttons on the camera back.

(3)Custom Function : LCD display when power is switched on

With the C.Fn-11-1 set to [Retain power OFF status] (Fig. 021), the camera settings will not be displayed. This will increase the number of possible shots to the same level as the EOS KISS DIGITAL N.

* In the Full Auto mode, since you need not worry about the shutter speed and aperture settings, using both C.Fn-11-1 and <DISP.> to display the camera settings only when necessary will further save battery power.

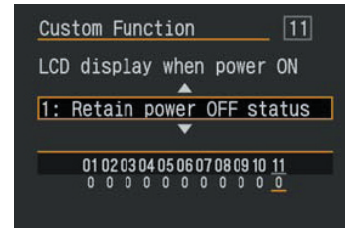

Fig. 021 C.Fn-11-1 screen

1.8 Built-in flash

The same flash unit (Guide No. 13) as the EOS KISS DIGITAL N's is used. To prevent the built-in flash's cover and fresnel from overheating and getting heat damage, the flash firing is restricted (as shown in Table 008) after you take 20 consecutive flash shots at an interval shorter than 10 sec. The degree of heating is the same as with the EOS KISS DIGITAL N and EOS 30D, and this anti-overheating feature has been incorporated for product safety.

If this safety feature prevents a flash picture from being taken, the "⚡ buSY" icon appears in the viewfinder and the "BUSY⚡" icon appears on the LCD monitor.

* The EOS KISS DIGITAL N and EOS 30D also have a safety feature to prevent overheating after 20 continuous flash shots. However, the cameras still immediately allows continuous flash shooting up to 20 shots if you let go of the shutter button and press it again to shoot. Since the safety feature was not really effective in these two cameras, the EOS D REBEL XTi / EOS 400D D now incorporates the above flash restrictions in both the single and continuous shooting modes.

Table 008 Flash Restrictions

Elapsed Time	Allowable Flash Shots
10 sec. - 40 sec.	1
40 sec. - 90 sec.	5
90 sec. -10 min.	10
10 min. or longer	20

1.9 LCD monitor and basic operation concept

1) LCD monitor

A 2.5-in., 230,000-pixel, color TFT LCD monitor (Fig. 022) with a wide viewing angle is used. Compared to the EOS KISS DIGITAL N's 1.8-in. LCD monitor, the display area is about twice as large. Also, to improve the menu's readability, the font size has been greatly increased.

The LCD monitor illumination is provided by three LED backlight modules. The brightness adjustment range has been expanded by one level at both the minimum and maximum levels.

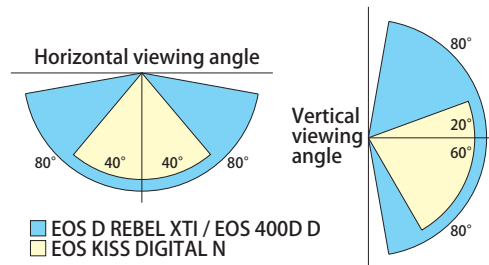

Fig. 022 Actual LCD monitor viewing angle

• About the maximum brightness

To make the image display easily visible even in the bright outdoors, the brightness level can now be set higher by one level compared to previous models (Fig. 023). Thanks to a highly transparent LCD monitor and very bright LED module (about 1.5 times brighter than the EOS 5D and EOS 30D's screens), the screen brightness is about 40% higher than the maximum brightness of the screens found on the EOS-1D Mark II, EOS 5D, and 30D. The maximum brightness setting changes the gamma characteristic to increase the midtones. It makes the image look more overexposed, and the highlight detail tends to be lost. Therefore, when checking the image's exposure and colors, the brightness level must be set to one of the middle five levels.

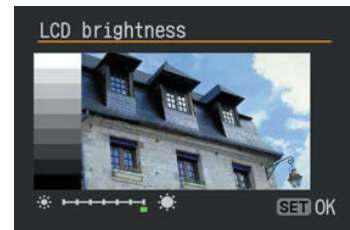

Fig. 023 Brightness adjustment screen

• About the minimum brightness

Since the EOS D REBEL XTI / EOS 400D D displays the camera settings at all times, set the screen brightness to a suitable level which would not be too bright in the dark.

(1) Display-off sensor

When you put your eye on the eyepiece, the display-off sensor (located below the eyepiece) senses your face and turns off the camera settings display automatically. This is to prevent the LCD monitor's brightness from disturbing your eye while looking at the viewfinder.

The display-off sensor consists of an IRED emitter and light-receiving sensor (Fig. 024). When the IRED light reflecting off the face is detected by the light-receiving sensor, the LCD monitor turns off automatically.

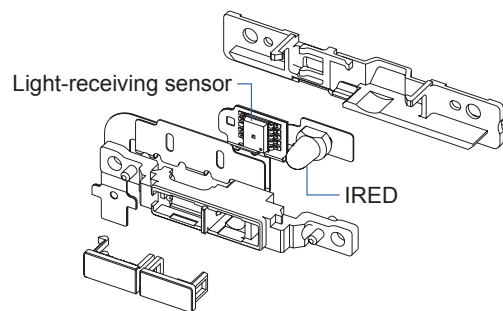

Fig. 024 Display-off sensor configuration

* If you are wearing sunglasses, it will disperse the IRED light and the display-off sensor might not be able to detect your face.

* If a fluorescent light inverter is within 30 cm/1.0 feet of the display-off sensor, a misoperation may cause the LCD monitor to turn off automatically.

2) Basic operation concept

(1) Basic operation

The basic operation procedure of using the main dial, cross keys, and various buttons to select and set functions is the same as with the EOS KISS DIGITAL N. One difference is the EOS D REBEL XTI / EOS 400D D's default operation to switch the screen display between the camera settings, menu screen, and image playback (Fig. 025). This is due to the camera settings now being displayed on the LCD monitor instead of on a separate LCD panel. The screen-switching procedure is described below.

• Displaying the camera settings on the LCD monitor at all times

Other than when the menu screen or image playback is displayed, the camera settings are displayed at all times.

• While the menu screen or image playback is displayed, pressing the shutter button halfway will display the camera settings

With previous cameras, pressing the shutter button halfway turned off the LCD monitor. With the EOS D REBEL XTI / EOS 400D D, it returns the screen to the camera settings display.

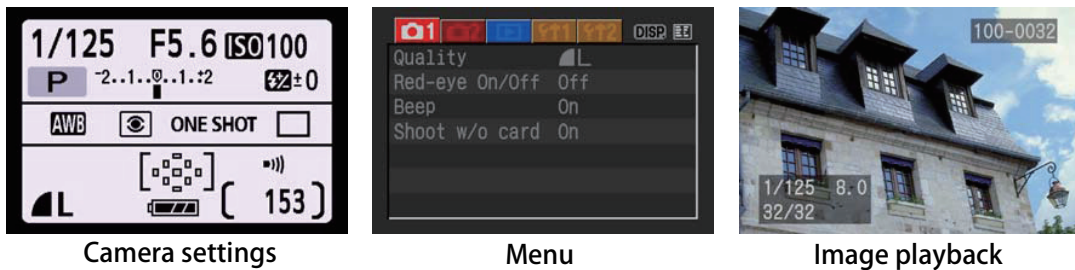

Fig. 025 LCD monitor display screens

(2) SET button and cross key function assignments

The SET button is for selecting the Picture Style directly. This is the default function. It promotes the use of Picture Styles which really differentiates the camera from its rivals (EOS D REBEL XTI / EOS 400D D: C.Fn-01-2). Also, the Picture Style logo is imprinted below the SET button (Fig. 026) to further promote this function.

The cross keys are assigned with functions to set the ISO speed, AF mode, white balance, and metering mode. The procedures to set the ISO speed, AF mode, white balance, and metering mode are the same as with the EOS 30D. The setting takes effect from the moment it is selected. You no longer need to press the SET button to register the setting.

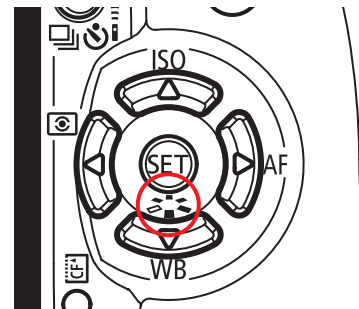

Fig. 026 Cross key

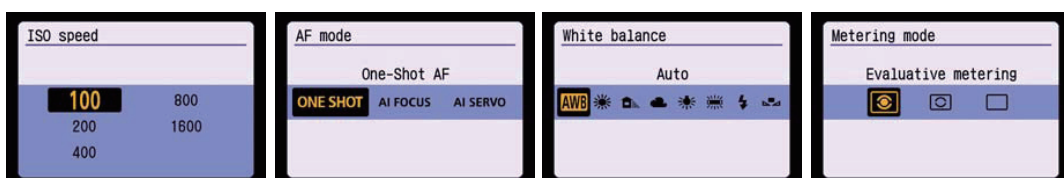

Fig. 027 Screens for selecting the cross key's function assignment

3) Image playback

The EOS D REBEL XTI / EOS 400D D can now display a magnified view during the image review immediately after shooting. Automatic image rotation and the RGB histogram display are also provided. Other than the above, the image playback specifications are the same as the EOS KISS DIGITAL N's.

1.10 Camera direct printing/Print order (DPOF)

The specifications are the same as with the EOS 30D.

With the EOS KISS DIGITAL N, it was necessary to use the [Communication] menu when switching between direct printing and connection to a personal computer. With the EOS D REBEL XTI / EOS 400D D, the communication method is now the same for both, making it unnecessary to switch it. The menu therefore no longer has the [Communication] setting.

1.11 Direct image transfer

The specifications are the same as with the EOS 30D.

1.12 Power source

The power source system is the same as the EOS KISS DIGITAL N as follows:

- Camera power source: NB-2LH
- AC power: ACK-DC20
- Battery Grip BG-E3: BGM-E3L (NB-2LH×2), BGM-E3A (size-AA battery×6)

1.13 Internal construction

1) Exterior covers and internal construction

The camera body construction is almost the same as the EOS KISS DIGITAL N's. A stainless steel chassis and a mirror box made of high-strength engineering plastic make the body as strong as the EOS KISS DIGITAL N's body (Fig. 028).

As with the EOS KISS DIGITAL N, the camera's top, front, and rear covers are made of special engineering plastic for lightweight, high strength, and electromagnetic shielding.

The exterior surface is coated with a leathery paint finish to make fingernail scratches less noticeable. The camera will come in two color versions, silver and black.

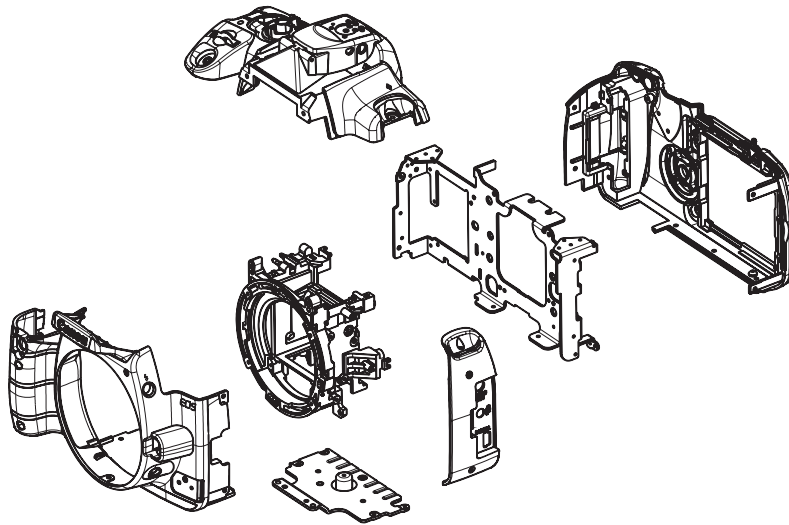

Fig. 028 Exterior covers and internal construction

2) Internal components and configuration

The basic internal components and configuration are the same as the EOS KISS DIGITAL N. The following units have been added or modified. Table 009 shows the parts breakdown and parts count. Also, Fig. 030 on page 19 shows the cross section at the center, and Figs. 031 and 032 on page 20 show the location of major parts.

- Self Cleaning Sensor Unit added
- Display-off sensor unit added
- LCD monitor size increased from 1.8 in. to 2.5 in.
- LCD panel eliminated

Table 009 Parts count

Item	EOS D REBEL XTi / EOS 400D D	EOS KISS DIGITAL N
Optics	21	18
Mechanical parts	245	220
Electrical parts	1046	915
Circuit boards	21	19
Lead wires	12	12
Total (Official)	1345	1184
Screws and washers	163	135
Total	1508	1319

* The shutter unit is counted as 1 part.

* The E-ring is counted as a washer.

* The official total excludes the screws and washers.

3) Shutter-release mechanism

The shutter-release mechanism, release stroke, torque (Table 010), and shutter-release time lag are the same as the EOS KISS DIGITAL N's.

Table 010 Shutter-release stroke and pressure

State	Stroke	Pressure
Shutter button protrusion	0.78mm	—
Standby position to SW-1 ON	0.5mm	0.1kgf
SW-1 ON to SW-2 ON	0.2mm	0.3kgf

4) Electrical components

While based on the EOS KISS DIGITAL N's electrical components, the EOS D REBEL XTi / EOS 400D D's electrical components are compatible with the new features such as the 10.10-megapixel CMOS sensor, Self Cleaning Sensor Unit, display-off sensor, and 2.5-in. LCD monitor.

As with the EOS KISS DIGITAL N, the EOS D REBEL XTi / EOS 400D D's main circuit board is a highly-integrated, 8-layer board fitted with the digital control circuit, camera control circuit, image-signal processing circuit, and DC/DC converter circuit. In addition, there are five hard boards (Fig. 029), and sixteen flexible boards.

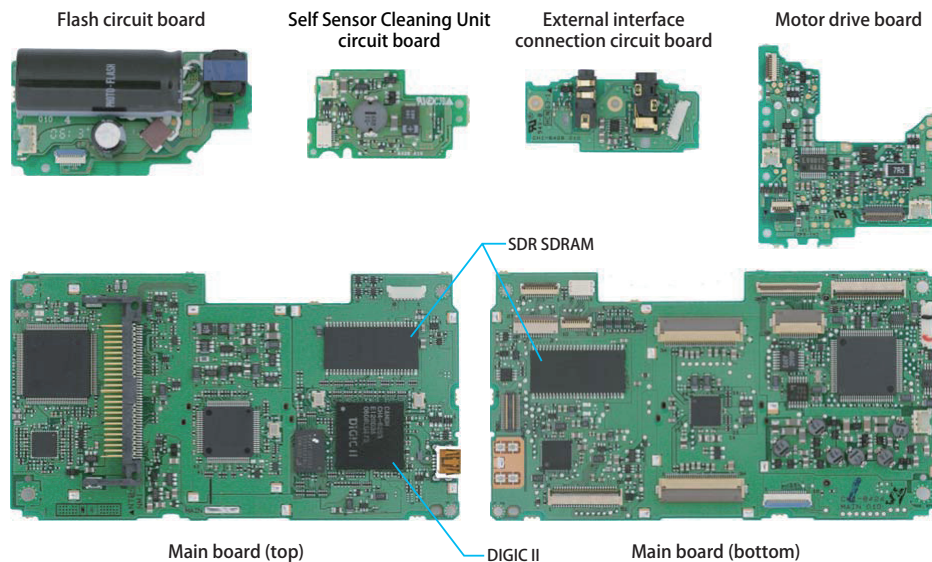

Fig. 029 Major hard boards

5) Compliance to RoHS directive (Restriction of the Use of Certain Hazardous Substances in Electrical and Electronic Equipment)

The RoHS directive will ban the use of the following six toxic substances in any electrical and electronic equipment: Lead, mercury, cadmium, hexavalent chromium, polybrominated biphenyl, and polybrominated diphenyl ether. It will take effect from July 1, 2006 and be applied to products sold in the EU. All of the EOS D REBEL XTi / EOS 400D D's parts conform to this directive.

*RoHS directive: Restriction of the use of certain Hazardous Substances in electrical and electronic equipment.

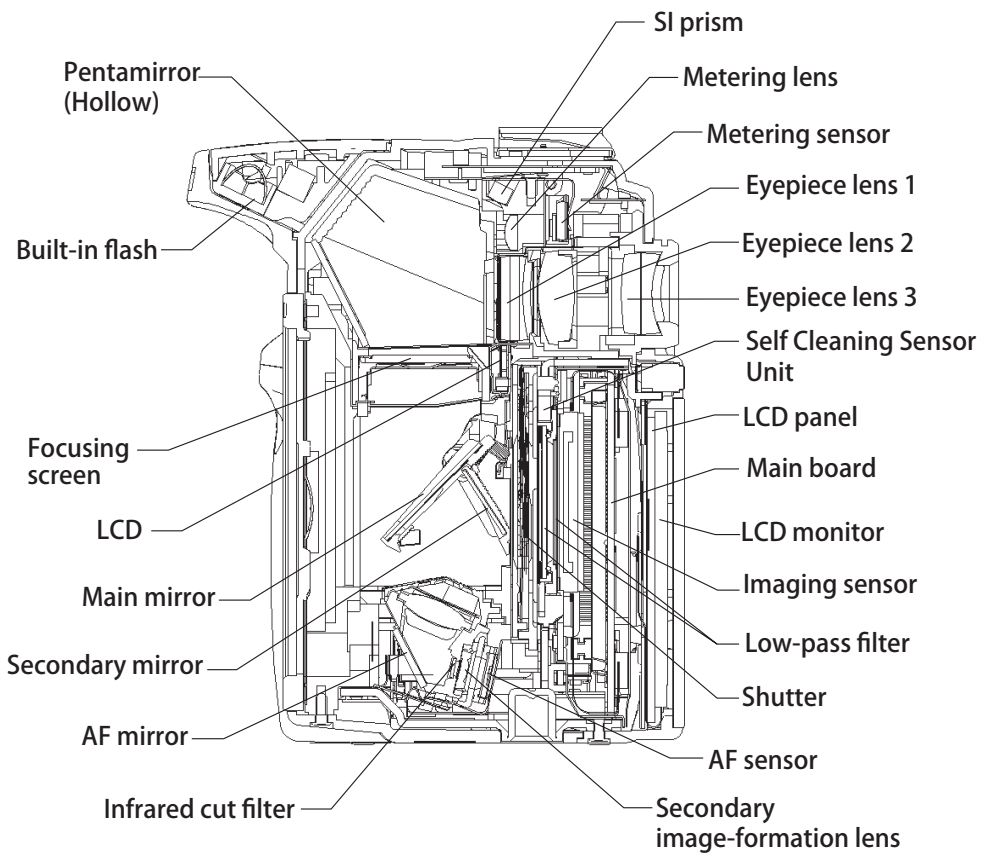

Fig. 030 Cross section at center

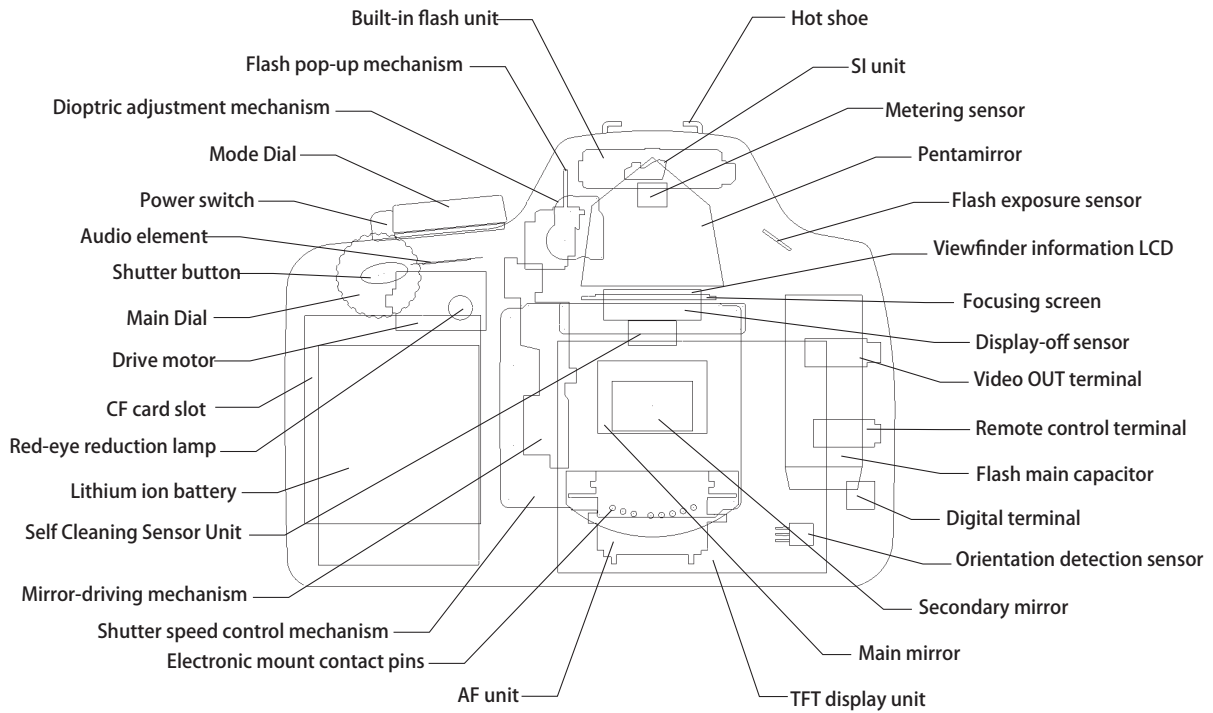

Fig. 031 Location of major mechanical components

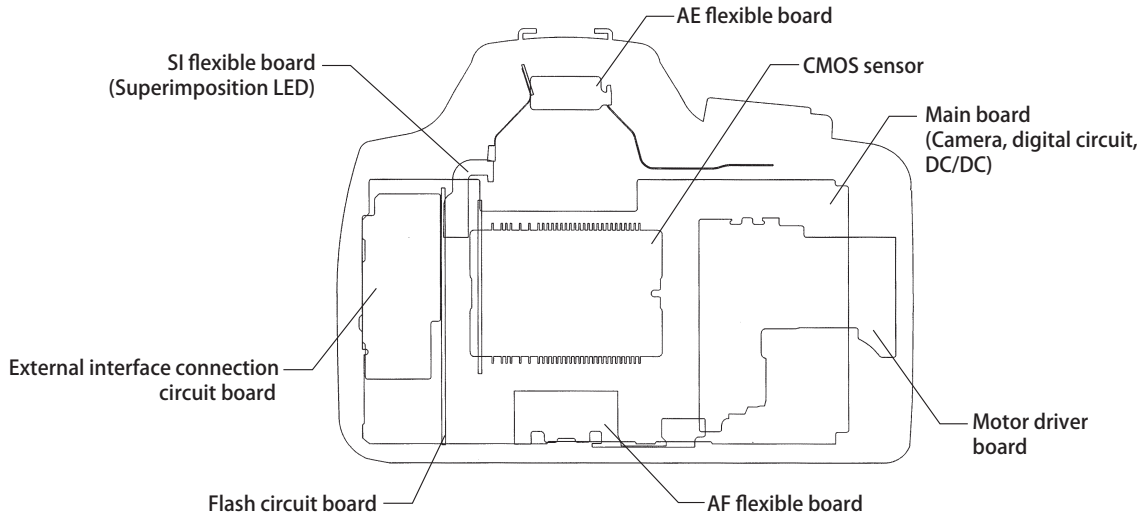

Fig. 032 Location of major circuit boards

Repair Information

Trademarks

The product names and company names described in this Service Manual are the registered trademarks of the individual companies.

Copyright

Canon Inc. retains the copyright to this Service Manual. Reproduction, publication (including on the World Wide Web), alteration, translation into another language, or other use of the data in whole or part, contained on this Service Manual without the written consent of Canon Inc. is prohibited.

CONTENTS

Repair Information	Page
1. REPAIR PREPARATIONS	1
1.1 Initial Check List	1
1.2 Cleaning Methods	2
1.3 Power Current Consumption Check	7
1.4 Residual Battery Display Check	8
1.5 Preparation of resistance part	8
1.6 Serial No. Replacement	9
1.7 How to Remove Connectors and Lead Wires	9
1.8 Self Cleaning Sensor Unit	10
1.9 Repair Tools and Material List	11
2. DISASSEMBLY AND ASSEMBLY	12
2.1 Disassembly of Side Cover and Back Cover	12
2.2 Removal of Front Cover Unit and Top Cover Unit	16
2.3 Removal of the Tripod Socket Plate, Main PCB, Interface PCB, CMOS Sensor Ass'y, and AF Unit	21
2.4 Removal of the Main Base Plate Ass'y, Flash PCB, ASD PCB, and MD PCB	27
2.5 Removal of the Mirror Box Ass'y, Shutter Ass'y, and Finder Unit	30
2.6 Disassembly of the Main Base Plate Ass'y	35
2.7 Disassembly of the Front Cover Ass'y	37
2.8 Disassembly of the Top Cover Ass'y	38
2.9 Disassembly of the Back Cover Ass'y	40

1. REPAIR PREPARATIONS

1.1 Initial Check List

1) Repair Workplace Environment

- Make sure that the workplace is protected from static electricity and also be sure to use antistatic wrist straps when assembling and disassembling.
- Before using major measuring tools (Light Source, AF Chart Stand, Standard Tool Lens, or Flange Back Tester), be sure to make an inspection and keep a record of the results routinely.
- Prepare a workplace that can be used as a dark room where there is more than 2.5 meters of space available.

2) Discharge Positions and Charge Inhibit Positions

After replacing the front cover, be sure to discharge from the main capacitor.

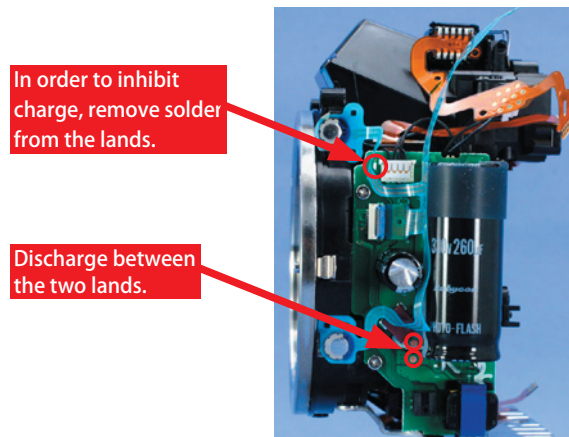

Fig. 001

3) Major Precautions

Before assembly, be sure to check the following precautions.



Fig. 002

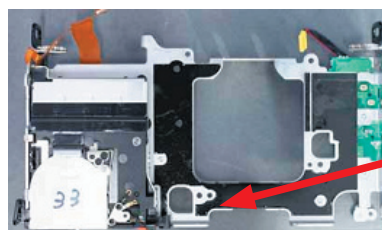

Fig. 003

Before attaching flexes, be sure to clean them with lens tissue soaked with Ethanol along the printed pattern of the flexes.



Fig. 004



Fig. 005

1.2 Cleaning Methods

1) Cleaning dust off the imaging surface (LPF surface)

Standard: Make sure that DIA (Digital Image Analyzer) displays “PASS” in the dust check when handling dust cleaning requests from users or when returning repaired products to users.

(1) Check images in DIA

DIA detects dust elements and counts the number. Based on the location, size, and number of dust specks, DIA judges “PASS” or “FAIL”.

1. Take a picture.

Shooting Conditions

- EF 50/1.8 lens
- Av Priority AE (F22)
- ISO 100, AWB
- JPEG Large/Fine
- Light Source (EF-1,8000 or Light Box)
- WB, tungsten

2. Download the image to a PC.

3. Open the JPEG file in DIA

4. The result of the judgment

If “FAIL” is displayed, click the number you want to check, and clean the dust after checking its position.

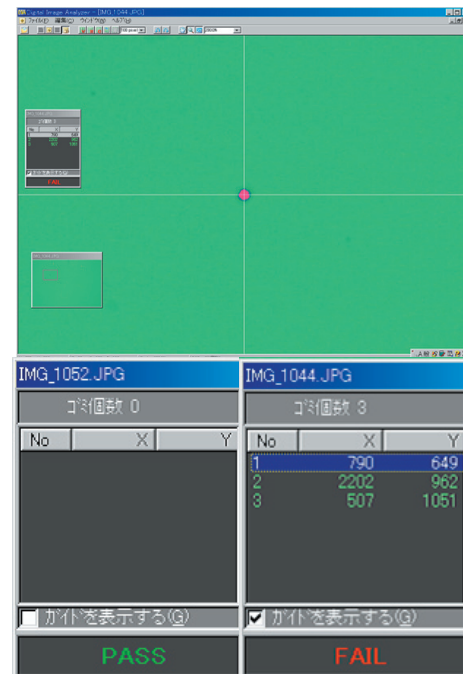

Fig. 006

(2) Cleaning the imaging surface (LPF surface)

Clean the parts of the imaging surface indicated in DIA using the dust loupe (CY9-1132). When the number of specks of dust is low, use a cotton swab to clean the locations where there is dust. Also, if you want to clean the entire surface, set the sensor cleaning to manual and clean it with 60g of pressure. Finally, clean it from the bottom edges to the top edges.

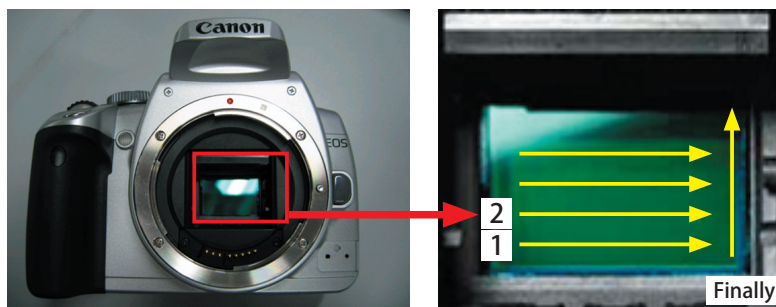

Fig. 007

2) Mirror Cleaning

Make sure that the adhesiveness of the main mirror and the sub-mirror has not decreased, and then blow off the dust with a blower. Clean up dust that was not blown off with lens tissue soaked with a small amount of Ethanol. (If too much Ethanol is applied, the adhesiveness of the main mirror becomes weak.)



Fig. 008

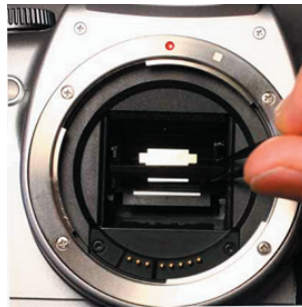

Fig. 009

3) Cleaning inside the Eyepiece Cover

(1) Cleaning before attaching Eyepiece Cover Unit

Blow off the dust with a blower, being careful not to touch the part circled in red. Clean up any dust that remains with a lens tissue soaked with Ethanol.

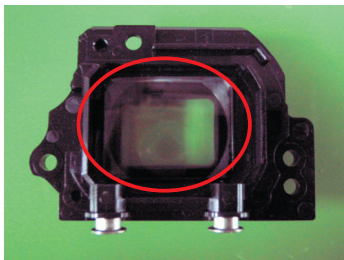

Fig. 010



Fig. 011

(2) Cleaning the Eyecup part

If the Eyecup part gets dirty with sand dust, blow off as much of it as possible with a blower. When cleaning off any remaining dust with lens tissue soaked with Ethanol, be sure to remove it from where it is without moving the tissue from side to side. Moving the tissue from side to side more than necessary may cause scratches on the surface.

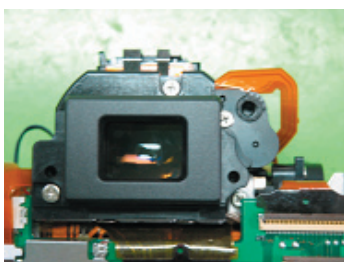

Fig. 012

4) Cleaning inside the viewfinder

(1) Disassembly of the Focusing Screen

- Place the camera upside down so that the mount part faces to the front.
- Grasp the clasp of the focusing screen retainer with tweezers and lift it in the direction of the main mirror to remove the retainer.
- Grasp the part of the focusing screen circled in red in the figure with tweezers and remove it without deforming the mirror cushion.
- Tilt the camera so that the mount faces directly upward and remove the focusing washers.

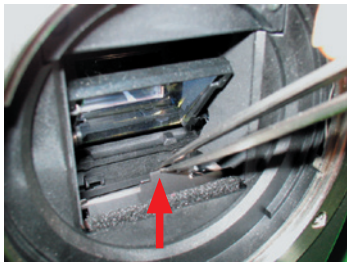

Fig. 013

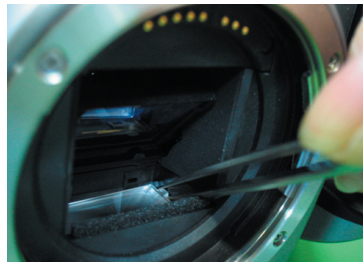

Fig. 014



Fig. 015

(2) Cleaning

- Blow off dust or fuzz inside the mirror box, being careful not to deform the mirror cushion.
- Clean off any remaining dust with lens tissue soaked with Ethanol while looking through the light box.



Fig. 016

(3) Reassembly of the Focusing Screen

- Place the camera upside down so that the mount part faces to the front.
- Grasp part A of the focusing washer with tweezers, as shown below, and attach the washer. Make sure that the narrower side is placed in the back.



Fig. 017

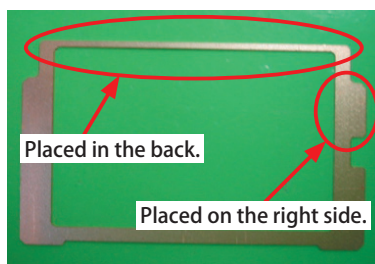

Fig. 018

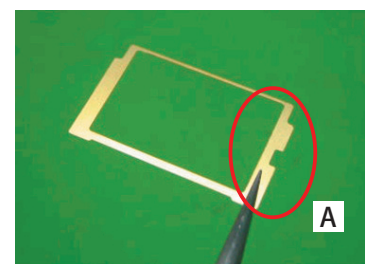

Fig. 019

- Grasp the focusing screen with tweezers so that the front side is up, and attach it according to three points circled in Fig. 021.



Fig. 020

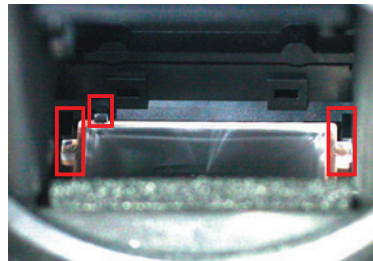

Fig. 021

(4) Assembly of Focusing Screen Retainer

- Make sure that the focusing screen retainer is not deformed and attach the retainer according to the holes of the mirror box.
- Check the clasp part of the focusing screen retainer reflected on the main mirror to make sure that the retainer is attached firmly without being lifted, as shown in Fig. 023.

Attach the retainer according to these holes.

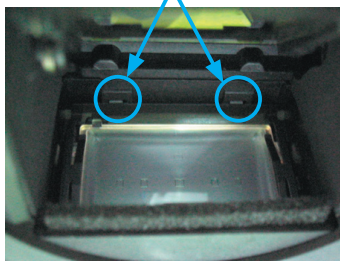

Fig. 022

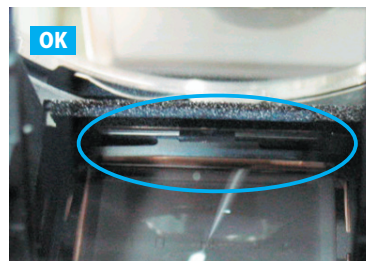

Fig. 023

(5) Final Check

- Look at the center AF point first, and then look to the right and left alternately to make sure that there is no tilt.
- Make sure that there is no fuzz or dust.

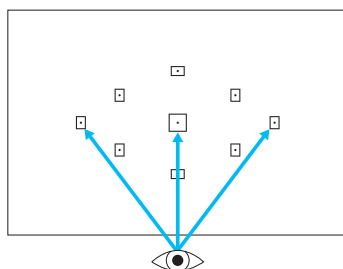

Fig. 024

5) Cleaning inside the TFT LCD

In order to clean up dust inside the TFT LCD, use a commercially-available suction cup to remove the TFT display window.

- Pour Ethanol fully into the border between the back cover and the TFT display window as indicated in red in Fig. 025, and then adsorb the TFT display window with the suction cup and lift it to remove.
- Blow off dust on the TFT LCD with a blower. Clean up any remaining dust with lens tissue soaked with a small amount of Ethanol.
- The TFT display window is likely to produce static electricity. To avoid having that happen, spray lightly on the TFT display window with an anti-static spray, and then wipe it off with a lens tissue soaked with a small amount of Ethanol.

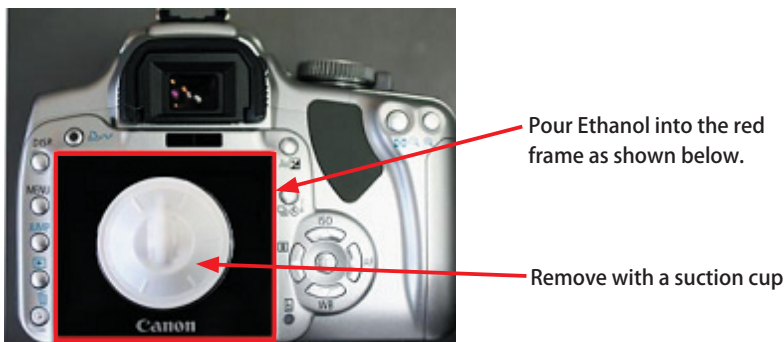

Fig. 025

1.3 Power Current Consumption Check

Current Consumption Standard

Lens: EF 50mm f/1.8 II,

Focusing Mode: MF,

Aperture: Maximum

Power source: Constant-voltage 7.5[V], 0.40[Ω] (Including wire resistance and contact resistance.)

CF card: (Hitachi or IBM micro drive with 2 GB or greater capacity)

Ambient conditions: Room temperature, normal humidity (below 60%)

Camera State	Product Standard	Actual Measurement
Power OFF	120 μ A or lower	45 μ A
Standby (TFT ON)	210 mA or lower	135 mA
Standby (TFT OFF)	65 mA or lower	35 mA
SW1 ON (TFT OFF)	320 mA or lower	175 mA
Self-Cleaning Function ON	1550 mA or lower	—

Note 1: Connect the resistance part with the tool battery for measurement.

Note 2: Actual measurement data is taken from the initial lot of mass production cameras. It may differ slightly with subsequent lots.

Note 3: Standby means the condition where the camera stands by while Main SW is on.

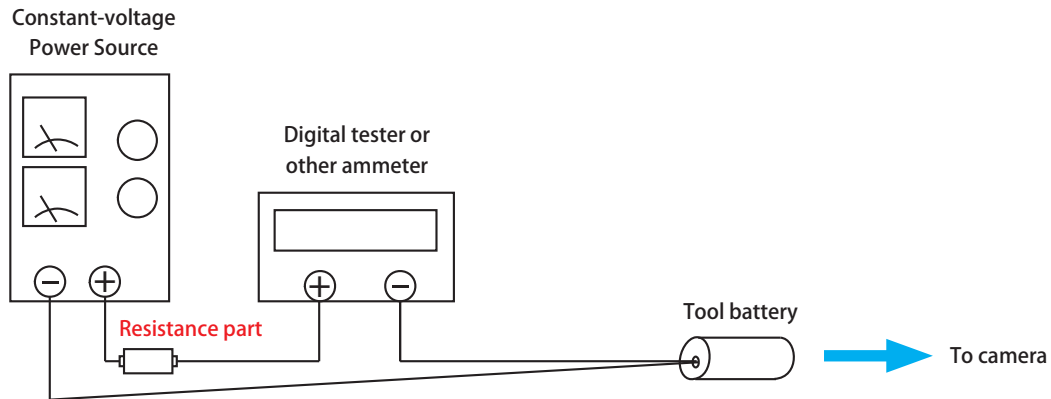

Fig. 026

1.4 Residual Battery Display Check





Tools: Use a tool battery and resistance (resistance value including wire resistance and contact resistance)

Power: Set the constant voltage to 8.0[V].

(1) Insert the tool battery into the camera.

(2) Turn on the main SW.

(3) Decrease the voltage supplied gradually holding SW1 ON to make sure the display switches within each voltage range.

Display	Lithium Ion Battery (Camera Body)
	
Range	$7.75 \pm 0.1V$
	
Range	$7.40 \pm 0.1V$
	
Range	$6.80 \pm 0.1V$
	Operation Disabled
Resistance	0.4Ω

1.5 Preparation of resistance part

1) What to prepare:

- (1) Film case × 1 (Procured commercially)
- (2) Probe × 1 (Procured commercially)
- (3) Joint plug × 1 (Procured commercially)
- (4) 0.5Ω , 5W resistance × 2 (Bundled with CY9-1101-000 TOOL BATTERY PROBE KIT)

2) Procedure:

- (1) Prepare above parts.
- (2) Make holes in the cover and the bottom of the film case to attach plugs. Insert the joint plug [A'] into the bottom hole and fix it with supplied washer from inside.
- (3) Solder two 0.5Ω resistances together in parallel, place it inside the film case and solder the end of the resistance [A] to the joint plug [A'] inside the film case.
- (4) Solder the other side of the resistance [B] to the probe [B'] inside the film case.

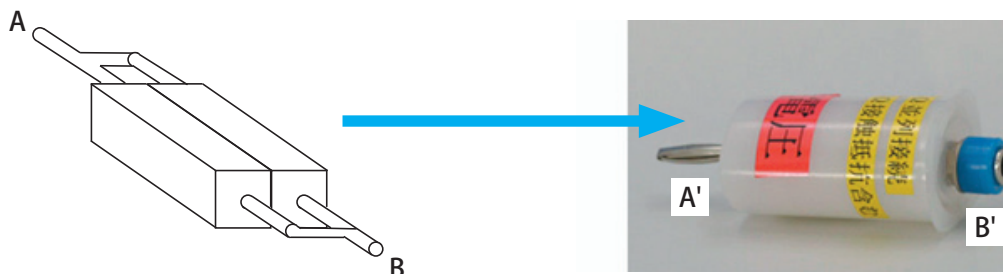

Fig. 027

1.6 Serial No. Replacement

Serial No. on the body number label (CY3-1565(S)/CY3-1566(B)) is used for various information such as service information after the product release. In particular, when the label is replaced with the service part, the classification number (forth and fifth digit of the serial number) is not reflected. Therefore, be sure to copy them to the surface of TFT holder unit base inside the camera.



Fig. 028

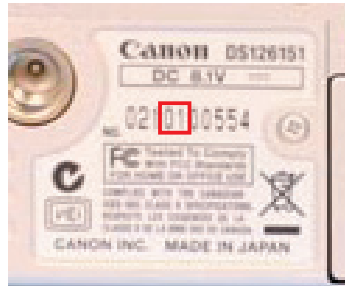

Fig. 029

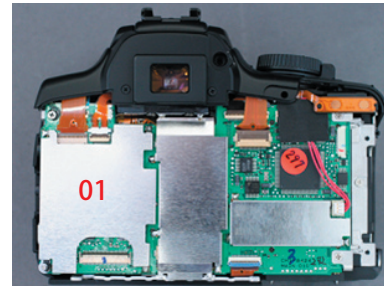
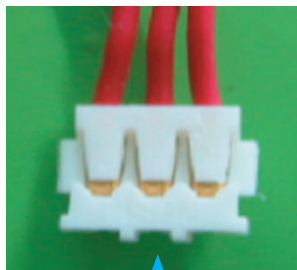

Fig. 030

1.7 How to Remove Connectors and Lead Wires

Make sure that front side of the connector is up, and then push to attach the connector until you hear a snapping sound. Deformed grooves may cause some damage in the connector.



Front side

Fig. 031

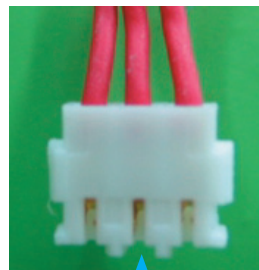

Back side

Fig. 032

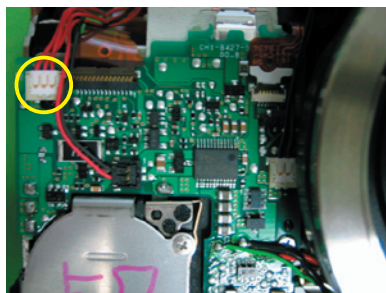

Fig. 033



Fig. 034

1.8 Self Cleaning Sensor Unit

Prior to developing this unit, we analyzed the causes of visible dust and their types and sizes. The dust becomes most noticeable at small apertures. We studied what sizes of dust were the worst offenders at small apertures. The Self Cleaning Sensor Unit was then developed to effectively eliminate those types of dust.

1) Unit configuration

Low-pass filter 1 on the front of the sensor is attached to an ultrasonic vibrating unit driven by a piezoelectric element. By subjecting low-pass filter 1 to ultrasonic vibrations, the adhering dust is shaken off the surface (Fig. 005). The removed dust then sticks to an absorbent material* ringing the low-pass filter 1. This unit also has an internal O-ring around the perimeter to keep out dust.

* Absorbent material: This is industrial-grade, double-sided tape. It does not lose its stickiness even after alot of dust adheres to it.

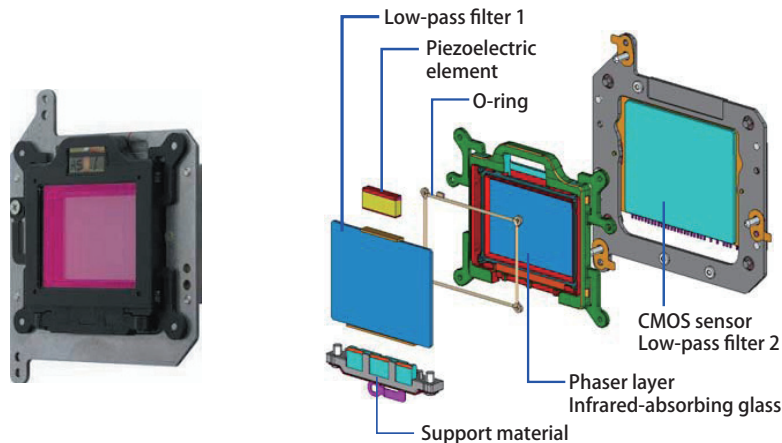

Fig. 035

2) Assurance of Sensor Cleaning Performance at Service Div.

It is difficult to attach the retention component to the low-pass filter and to apply the O ring. In order to maintain the self-cleaning performance, when any problems are found, be sure to replace the CMOS sensor unit with new one, instead of trying to repair the unit. Also, you can determine whether the sensor cleaning operation is working correctly by the sound (very small sound) it makes when operating. When it is working properly, you can hear the sound.

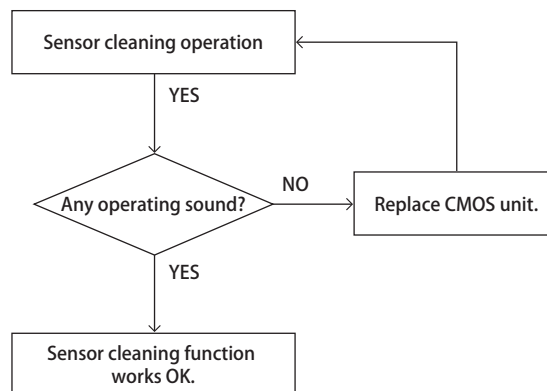

Fig. 036

1.9 Repair Tools and Material List

The following tools and materials are required for camera reassembly and adjustment.

1) Tools List

New	Name	Part No.
	SOLDER, LEAD FREE (RMA-98 SUPER)	CY9-4045-000
	SOLDER WICK NO.2/NO3 (1.5MM/2MM)	CY9-1036-001/002
	SHEET CONDUCTIVE	CY9-1061-000
	STRAP, WRIST (EARTH)	CY9-6158-000
	LIQUID DISPENSER	CY9-4017-000
	TWEEZERS (AA TYPE/GG TYPE)	CY9-4018-001/002
	BLOWER (RUBBER)	CY9-4020-000
	LENS TISSUE (K-1 THICK/K-3 THIN)	CY9-4023-001/003
	SCREW DRIVER HANDLE	CY9-7014-001
	GROSS-RECESS BIT TB35-5 (Φ3mm, l=50mm)	CY9-7014-002
	GROSS-RECESS BIT TB35-6 (Φ2.5mm, l=115mm)	CY9-7014-003
	GROSS-RECESS BIT TB35-7 (Φ2.5mm, l=50mm)	CY9-7014-004
	GROSS-RECESS BIT TB35-8 (Φ2mm, l=50mm)	CY9-7014-005
	TOOL BATTERY PROBE KIT (CABLE)	CY9-1101-000
	ADAPTOR, POWER SUPPLY (DP-700)	CY9-7125-000
	LOUPE, DUST CHECKING	CY9-1132-000

2) Locally Made Tools

New	Name	Part No.	Purpose/Subject
	Resistant part	Locally-made	Inhibits voltage

3) Other Products for Testing

New	Name	Part No.	Purpose/Subject
	EF50mm/f1.8 II	Production Lens	Camera operations, adjustments, checking
	Speedlite (380EX, 550EX, or other E-TTL)		Flash metering adjustments
	CF Card	Commercially available	Image check

4) Expendables List

New	Name	Part No.	Purpose
	TAPE (NO.510FR) ACETATE(R)	CY9-4026-000	M2 Motor
	TAPE (No.315)	CY9-4031-000	—
	TAPE, DOUBLE SIDED	CY9-4034-000	Body
	BOND, ARONALPHA #201	CY9-8007-000	Securing SPD and SI in place
	BOND ARONTITE L	CY9-8008-000	For screw head
	BOND THREE BOND 1401C	CY9-8011-000	Screw Lock
	LUBE, DEFRIC GREASE UTLM-10	CY9-8031-000	Mirror parts
	BOND, KE-347-B, SI.RUBBER	CY9-8064-000	Water resistance
	LUBE, NPC H-26, GREASE	CY9-8079-000	Friction surfaces of springs, etc.
	LUBE, NPC IF-10, GREASE	CY9-8088-000	Mount spring friction surfaces
	LUBE, LOGENEST LAMBDA NFH-743C	CY9-8125-000	Front cover's friction surfaces
	LUBE, LOGENEST RAMBDA A-74	CY9-8102-000	M2 gear shafts
	LUBE, LOGENEST RAMBDA NK-74C	CY9-8117-000	Lubricating material
	BOND, CEMEDINE SUPER X 8008	CY9-8118-000	Mount ring adhesion, etc.
	BOND, DIABOND NO.1663G BLACK	CY9-8129-000	Adhesive for parts
	LUBE, FLOIL 923 GREASE 20G	DY9-3042-000	FPC surface

2. DISASSEMBLY AND ASSEMBLY

2.1 Disassembly of Side Cover and Back Cover

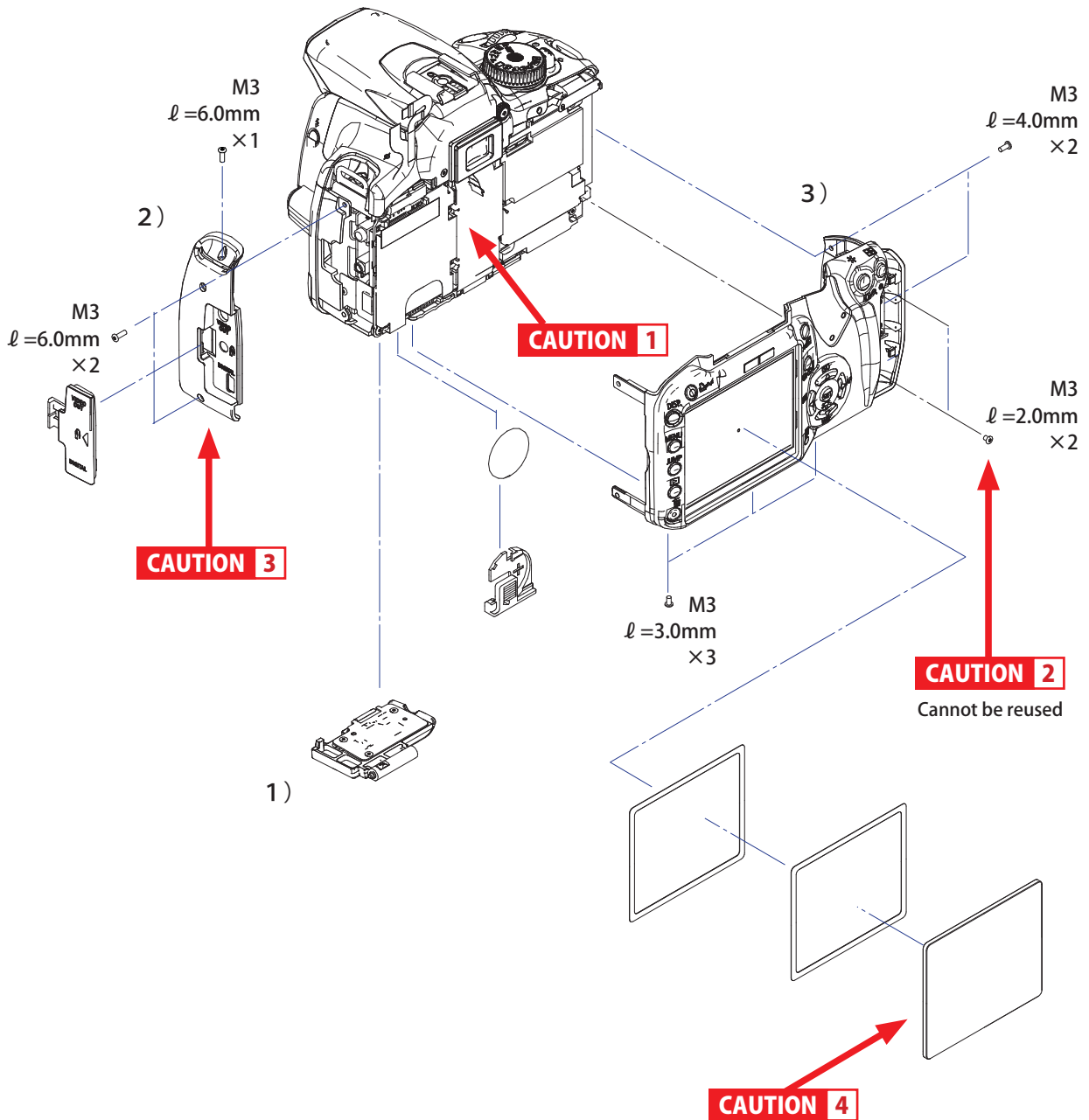

Fig. 037 Disassembly of Side Cover and Back Cover

<Disassembly Procedures>

1) Battery Cover Unit

- (1) Open the battery cover and slide the hinge of the shaft to remove the battery cover unit.
- (2) Slide the lithium battery to remove.

2) Side Cover

Remove two screws and lift the side cover in the direction indicated with an arrow to remove.



Fig. 042

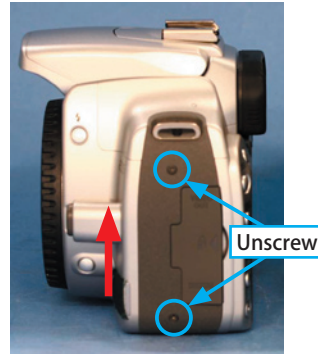

Fig. 043

3) Back Cover Unit

- (1) Remove three screws from the bottom.
- (2) Open the CF card slot and remove the two screws shown below.
- (3) Remove two screws on the grip side.
- (4) Push part circled in red down to unhook the back cover from the top.
- (5) Remove the connector and remove the back cover unit.



Fig. 038

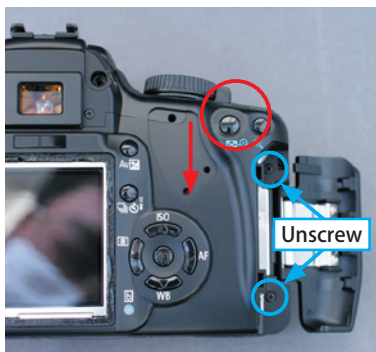

Fig. 039



Fig. 040

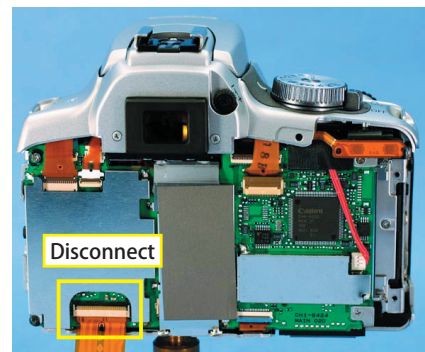

Fig. 041

<Reassembly Cautions>

1) Back Cover Unit

- (1) Make sure that the Main PCB shield case is soldered properly and that the three connectors are locked.

CAUTION 1 Make sure that the noise prevention sheet is applied to the Main PCB shield. Without the noise control sheet, images will have stripe noise, so please be careful.

- (2) Make sure that there are no scratches on the back cover unit and install the flex.
 (3) Attach the back cover unit from the bottom side carefully, so as not to catch the TFT flex. Be careful not to break the clasp of the top cover unit. When assembling the back cover, be sure to keep the CF slot part opened to protect the switch.

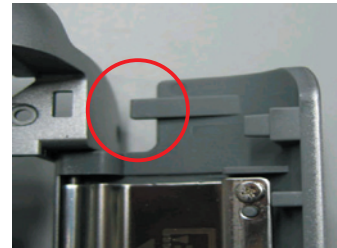

Fig. 044

CAUTION 2 The screws inside the CF card slot are not reusable, so be sure to replace them with new ones.

2) Side Cover

- (1) Fit the parts circled in red (shown in Fig. 045) on the terminal cap into the grooves of the side cover and assemble the side cover from the top cover unit side.
 (2) Press the side cover in this order: center, top, and bottom part.

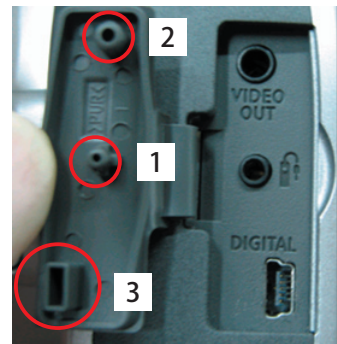

Fig. 045

CAUTION 3 If you press the side cover first, the remote controller and USB part will be deformed. Be sure to follow the correct order: center → top → bottom.

- (3) Make sure that there is no gap between the side cover unit and the top cover unit, and then screw the side cover starting from the top and finally screw the bottom part of the back cover unit starting from the center.



Fig. 046



Fig. 047



Fig. 048

3) Reassembly of TFT display window

(1) Align the TFT light shield holder to the right edge and attach it so that the clasps fit into place properly.

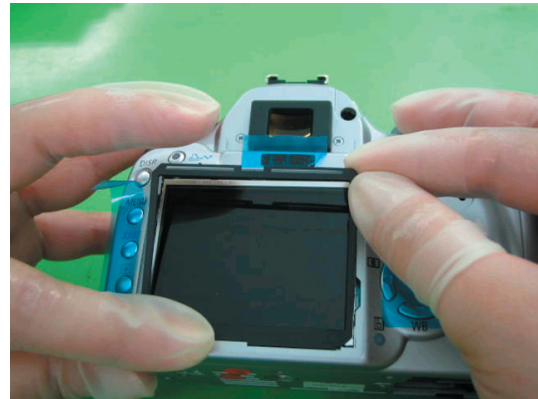

Fig. 049

(2) Peel off the backing sheet of the double-sided tape for the TFT display window and apply the tape according to the red line as shown in Fig. 050.

(3) Hold the edge of the double-sided tape for the TFT display window and remove the covering sheet.

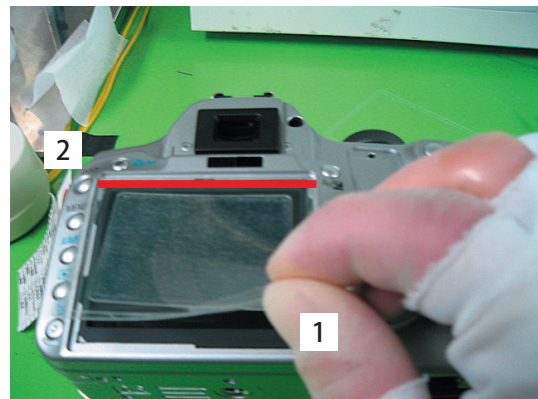

Fig. 050

(4) Make sure that there is no dust on the TFT, and then assemble the TFT display window from the bottom side.



Fig. 051

CAUTION 4 Be sure to apply the solvent properly. If too much solvent is applied to the TFT display window, it will get dirty and its adhesiveness is weakened.

2.2 Removal of Front Cover Unit and Top Cover Unit

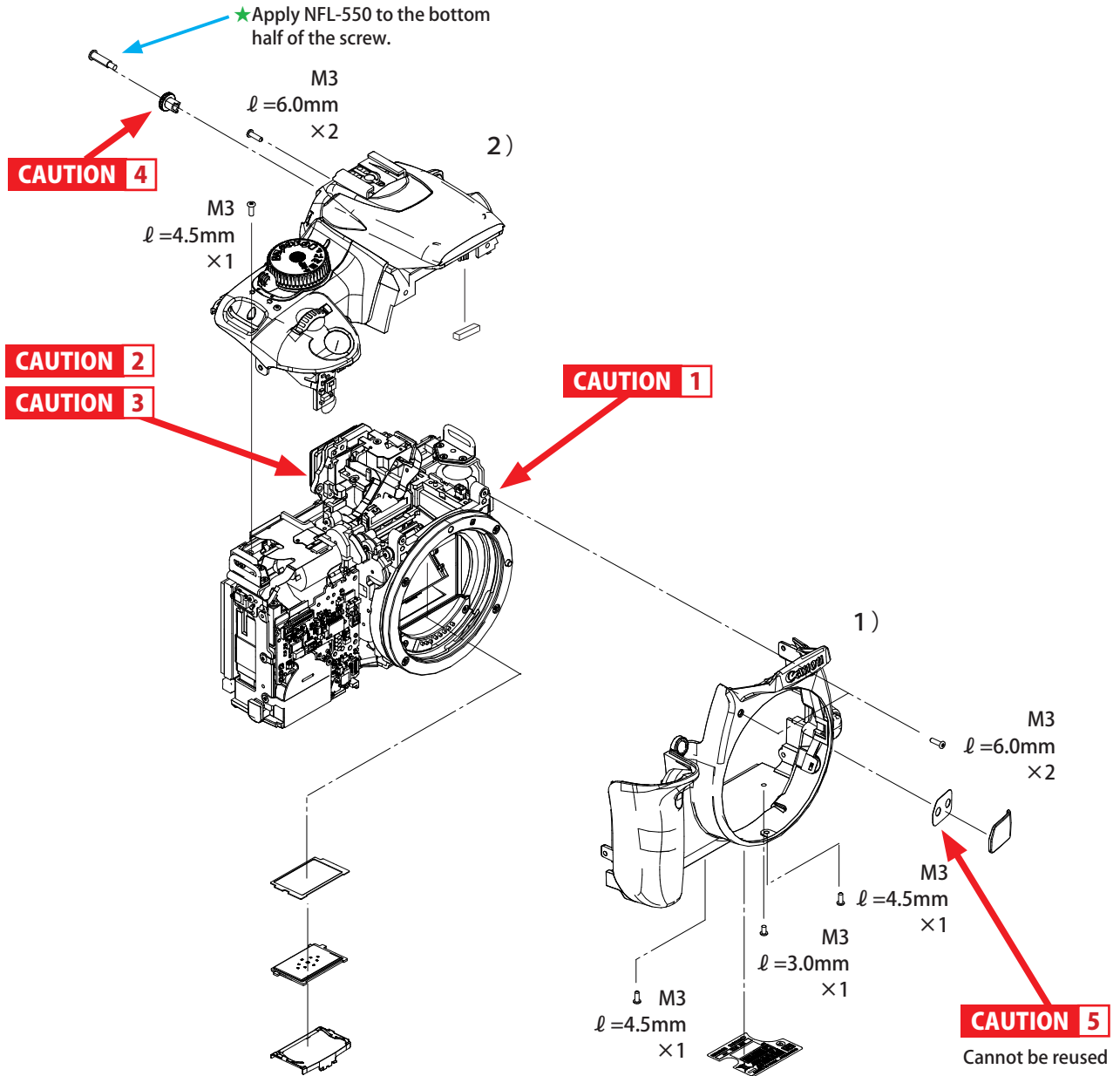

Fig. 052 Removal of Front Cover Unit and Top Cover Unit

<Disassembly>

1) Removal of the Front Cover Ass'y

- (1) Remove two screws from the front, three screws from the bottom.
- (2) Insert the tip of a pair of tweezers, and lift the Front Cover Ass'y over the tripod screw to remove it.
- (3) Discharge by using discharge resistance.



Fig. 053

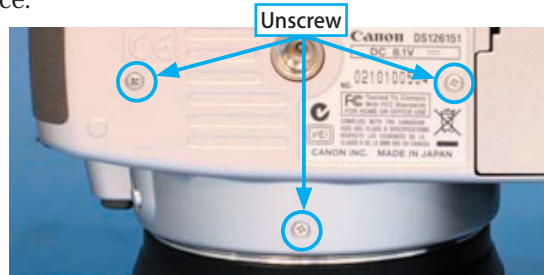

Fig. 054

CAUTION 1 After replacing the Front Cover Ass'y, make sure to discharge the main capacitor.

2) Removal of the Top Cover Ass'y

- (1) Remove three screws from the back and one screw from the top.
- (2) Disconnect the flex connector at two positions.
- (3) Disconnect the lead wire with the connector at two positions and remove the Top Cover Ass'y.

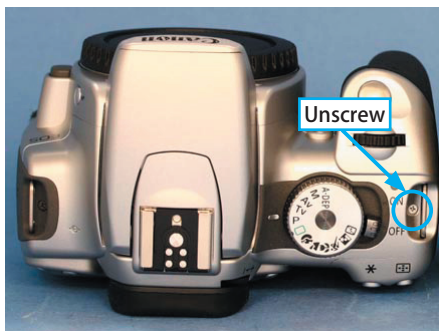

Fig. 055

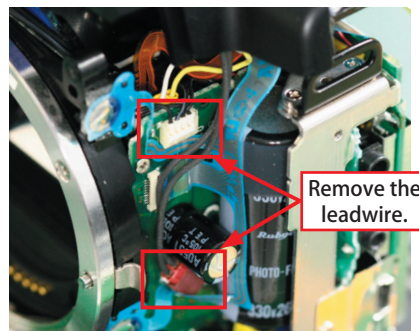

Fig. 056

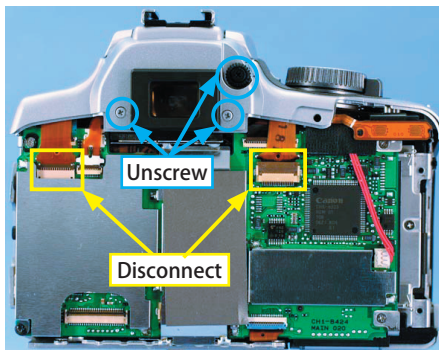

Fig. 057

<Reassembly Cautions>

1) The Top Cover Ass'y

- (1) Make sure that Aron Alpha at the Exposure Processing FPC Ass'y is white and dry.

CAUTION 2 Note that if the Top Cover Ass'y is assembled when the Exposure Processing FPC Ass'y is not firmly fixed, adjustment is necessary.

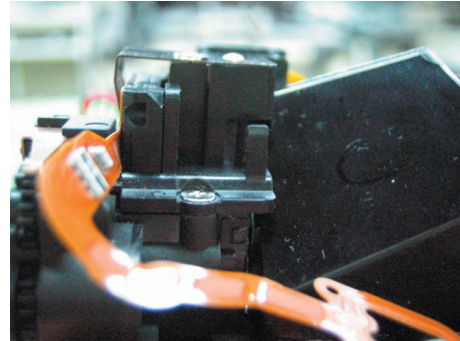

Fig. 058

- (2) Attach the gasket to the back of the Top Cover Ass'y as shown in Fig. 059.
 (3) Insert the connector to the end, making sure it is in the correct direction.

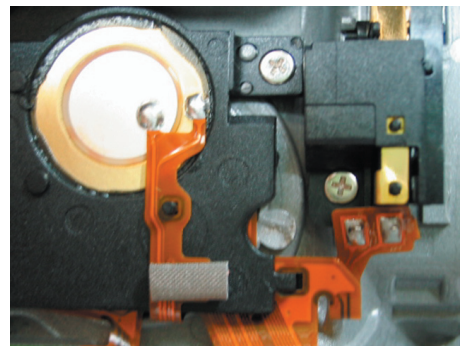

Fig. 059

- (4) Make sure to solder Part A firmly and assemble the Top Cover Ass'y.

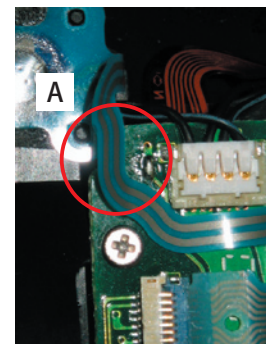

Fig. 060

- (5) Assemble FPC at two positions.

CAUTION 3 When inserting FPCs with a pair of tweezers, make sure not to distort the connector and pin and check whether FPC is inserted correctly after reassembly.

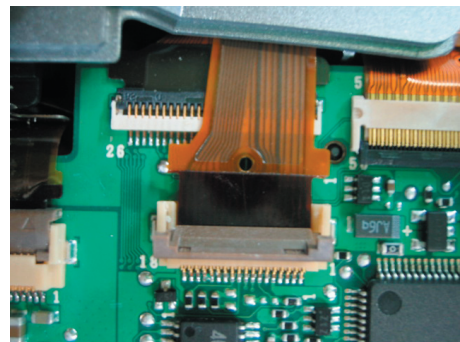

Fig. 061

- (6) Check the position of screw holes and screws while making sure that there is no damage and peeling of paint.
- (7) Make sure the side of the connector is correct and insert it into the Flash PCB to the end. Route the lead wires as shown in Fig. 062.



Fig. 062

- (8) Apply the specified expendable to more than half the circumference of the Diopter Adjustment Dial and assemble it firmly, making sure that there is no damage or peeling of paint as with the other screws.



Fig. 063

CAUTION 4

- When expendables are applied from the outside, they need to be wiped off, so they should be applied from the inside.
- The Diopter Adjustment Dial is a different part from EOS KISS DIGITAL N, so assemble the correct part to the correct position.

For EOS D REBEL XT1 / EOS 400D D

For EOS KISS DIGITAL N

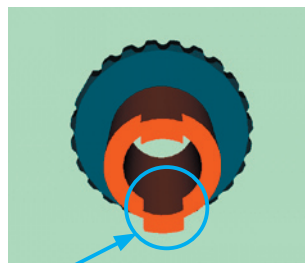
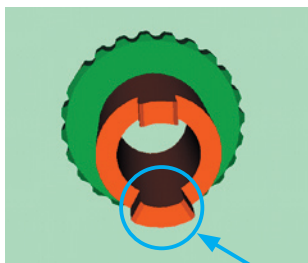

The size of this part differs

Fig. 064

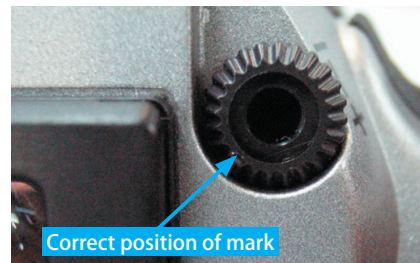

Fig. 065

2) Attachment of the Model Name Plate

- (1) Firmly attach the double-sided tape for the Model Name Plate to the center of the attachment position.
- (2) Peel off the top paper of the double-sided tape with a pair of tweezers, making sure that the tape is not twisted, and assemble the dowels of the Model Name Plate perpendicular to the body.



Fig. 066

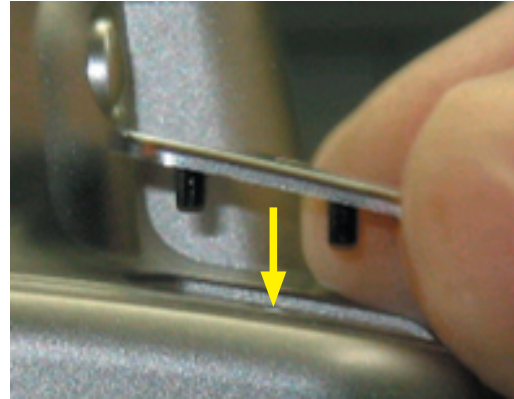

Fig. 067

CAUTION 5

- The double-sided tape cannot be reused, so if it is peeled once, replace it.
- Make sure that the model name is correct before attaching it.

2.3 Removal of the Tripod Socket Plate, Main PCB, Interface PCB, CMOS Sensor Ass'y, and AF Unit

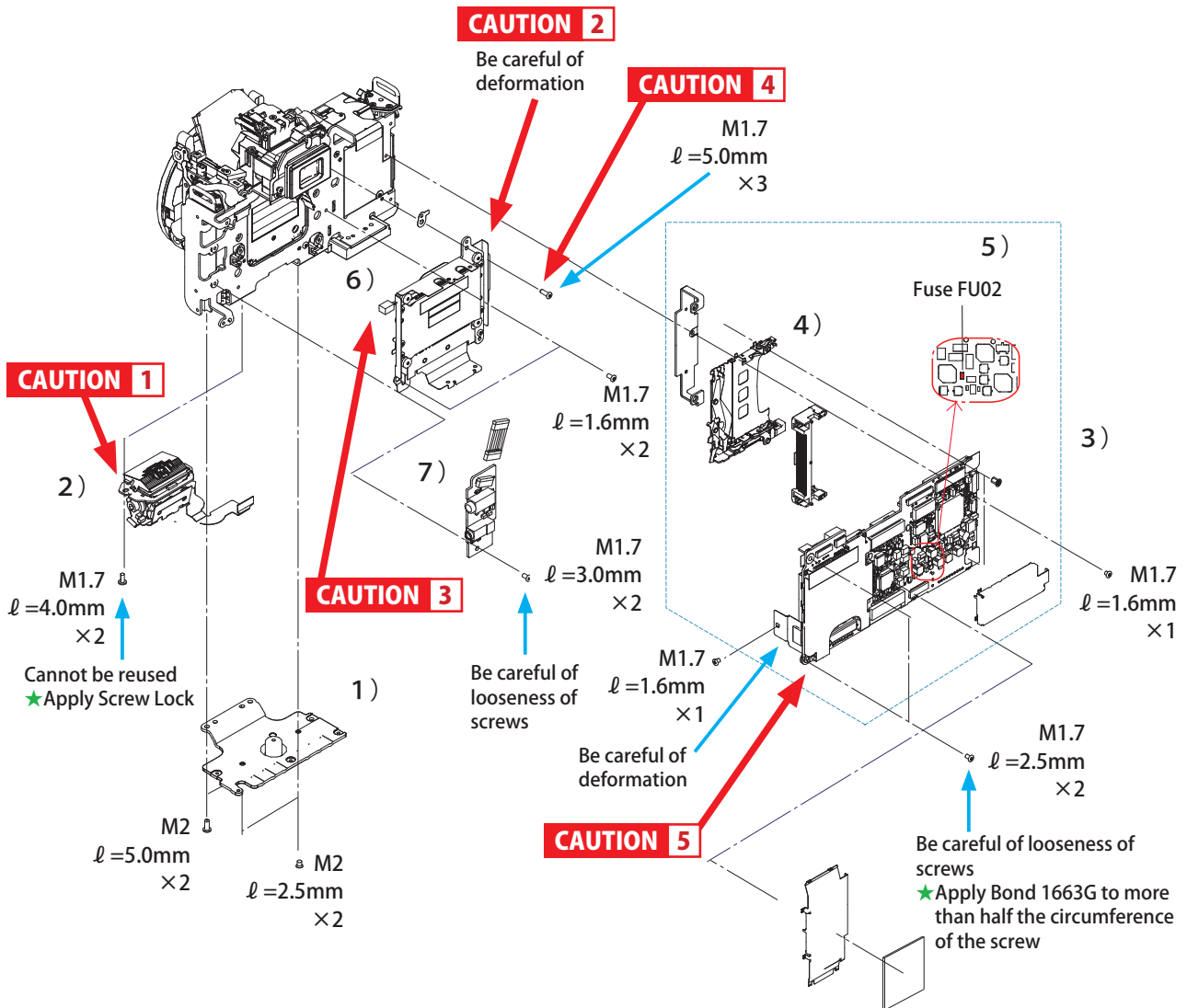

Fig. 068 Removal of the Tripod Socket Plate, Main PCB, Interface PCB, CMOS Sensor Ass'y, and AF Unit

<Disassembly Procedures>

1) Removal of the Tripod Socket Plate

Remove four screws and the Tripod Socket Plate.

2) Removal of the AF Unit (Disassemble if necessary)

Remove a flex connector and two screws and lift the AF Unit slowly to remove it.

CAUTION 1 Disassembly is not usually performed because it requires making adjustments when the AF Unit is disassembled. Screws cannot be reused, so replace them with new ones when assembling.

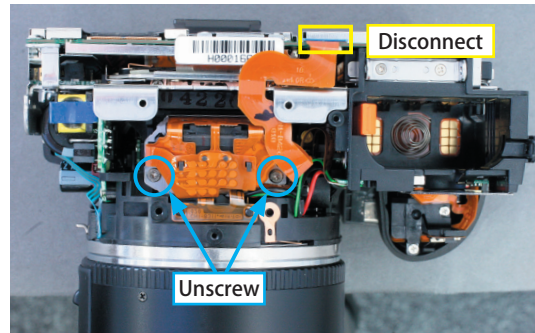

Fig. 069

3) Removal of the Main PCB Ass'y

(1) Unsolder at seven positions to remove the Main PCB shield case.

(2) Remove the flex connectors at seven positions.

(3) Remove lead wires with connector at front and back.

(4) Remove three screws and one screw from the back and remove the Main PCB Ass'y.

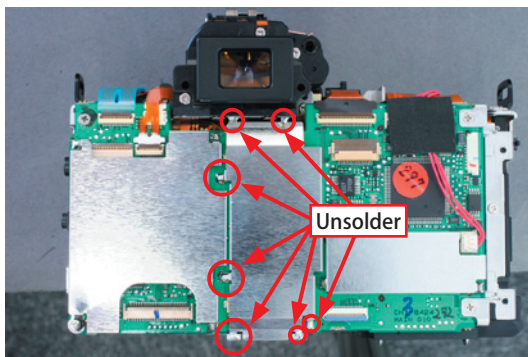

Fig. 070

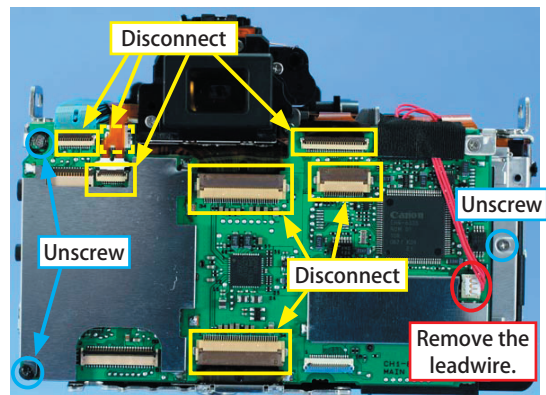

Fig. 071

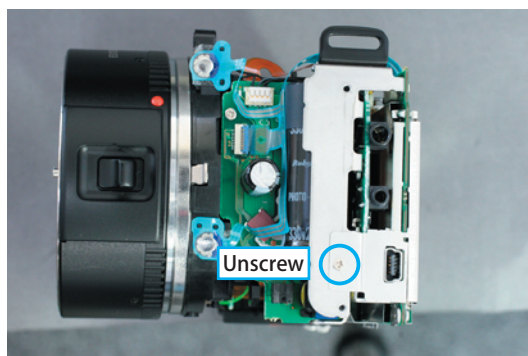

Fig. 072

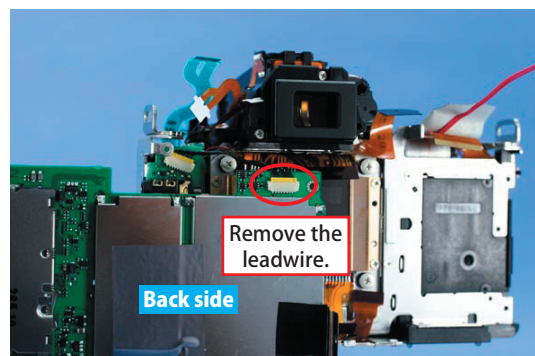

Fig. 073

4) Removal of the CF Slot Part

(1) Remove two screws and remove the plate.

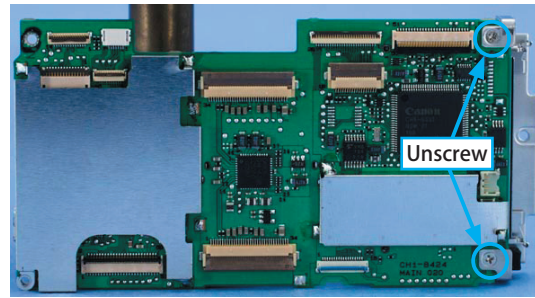

Fig. 074

(2) Remove two clasps and lift the CF slot cover directly upward.

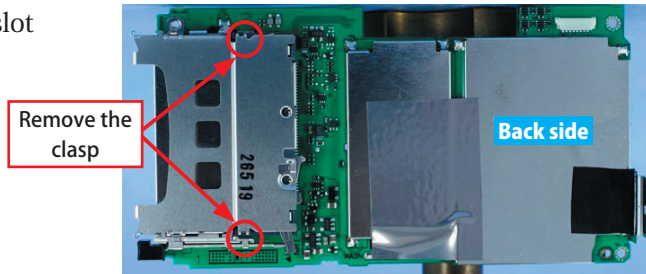

Fig. 075

(3) Unsolder at two positions and comb solders to remove the CF slot pin unit.

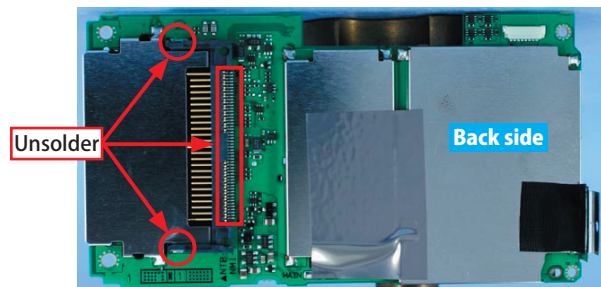

Fig. 076

5) Replacement of the Fuse

Unsolder at three positions to remove the plate.

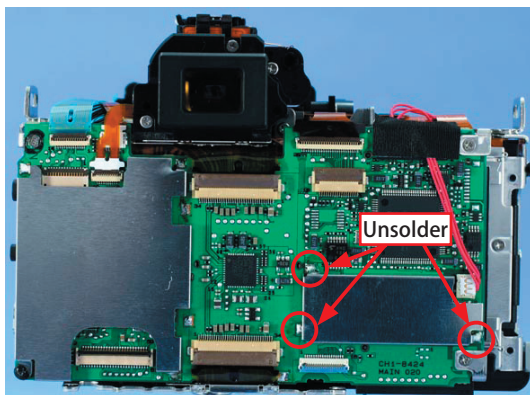

Fig. 077

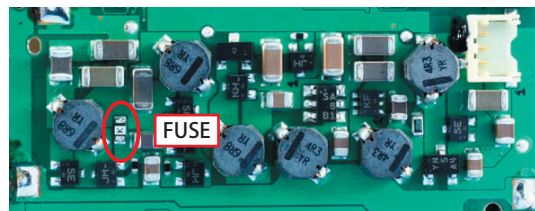

Fig. 078

6) Removal of the CMOS Sensor Ass'y

- (1) Remove two screws of shield and three screws of the back.
- (2) Remove the lead wire connector at one position to the ASM PCB.
- (3) Remove the CMOS Sensor Ass'y, making sure not to damage it.
- (4) Screw three Flange Back washers to the original positions temporarily, so as not to lose them.

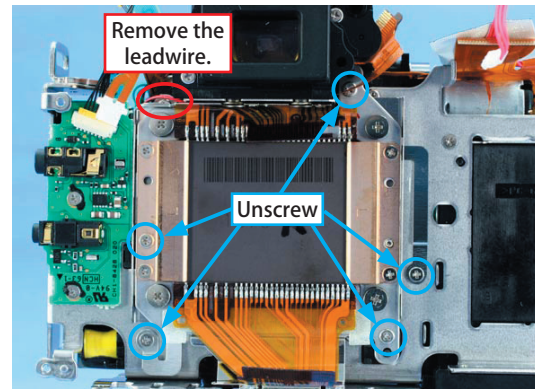

Fig. 079

CAUTION 2

- Wear an antistatic strap when removing the CMOS Sensor Ass'y and keep it in the place where countermeasure against static electricity are in effect.
- Be careful not to damage or stain the removed CMOS Sensor Ass'y and handle it so as not to deform the exterior plate.

7) Removal of the Interface PCB Ass'y (Disassemble if necessary)

Remove two screws and lift the Interface PCB Ass'y to remove it.

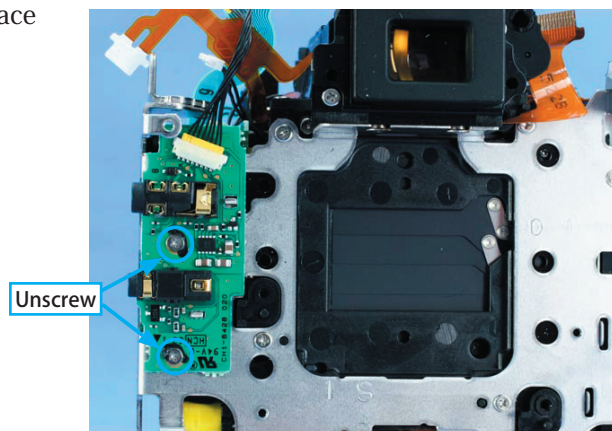

Fig. 080

<Reassembly Cautions>

1) The CMOS Sensor Ass'y

- (1) Reassemble the CMOS sensor to match the reference point dowels to determine the positioning, make sure that there is no dirt on the CMOS Sensor Ass'y, and decide the position by avoiding the lead wire.

CAUTION 3 When the Main Base Plate Ass'y and lead wire touch, it causes ActiveSweep operation malfunctions, so be careful not to pinch the lead wire.

- (2) Screw in the order shown in Fig. 081.

CAUTION 4 The length of screw differs from EOS KISS DIGITAL N, so use screws of the correct length.

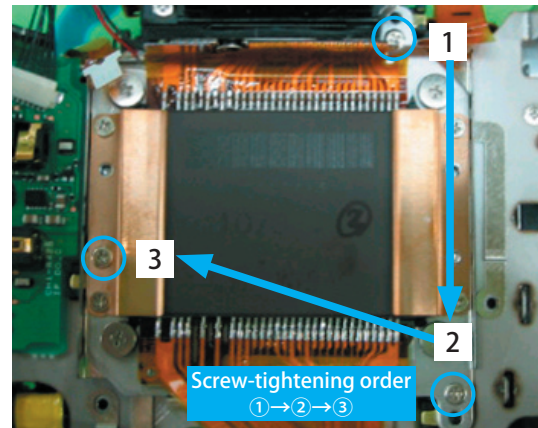

Fig. 081

2) The Main PCB Ass'y

- (1) Check whether two pieces of insulating tape are attached firmly in the positions shown in Fig. 082.

- (2) While being careful not to distort Part A in Fig. 082, release the FPC and attach four screws so that the PCB does not move.

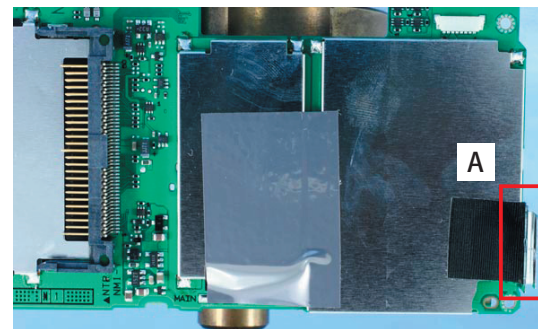

Fig. 082

- (3) Apply Bond 1663G to the two screws shown in Fig. 083.



Fig. 083

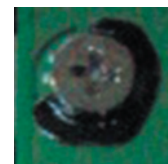

Fig. 084

(4) Attach the lead wire from the Main PCB Ass'y to the MD Ass'y and make sure that the direction is correct. Route the lead wires as shown in Fig. 085, 086 and be careful that they do not go outside of the PCB.

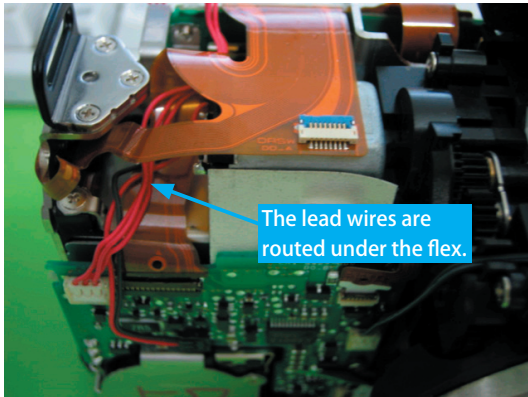

Fig. 085

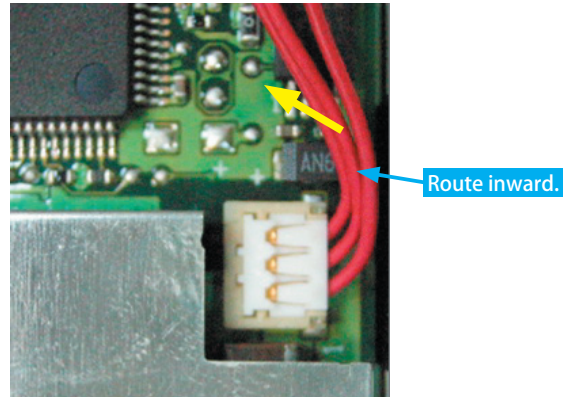

Fig. 086

CAUTION 5 If the FPC is slanted when inserted, it will cause poor contact, so check the insertion after inserting it.

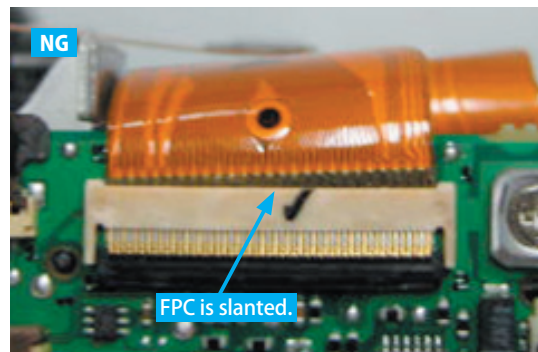

Fig. 087

2.4 Removal of the Main Base Plate Ass'y, Flash PCB, ASD PCB, and MD PCB

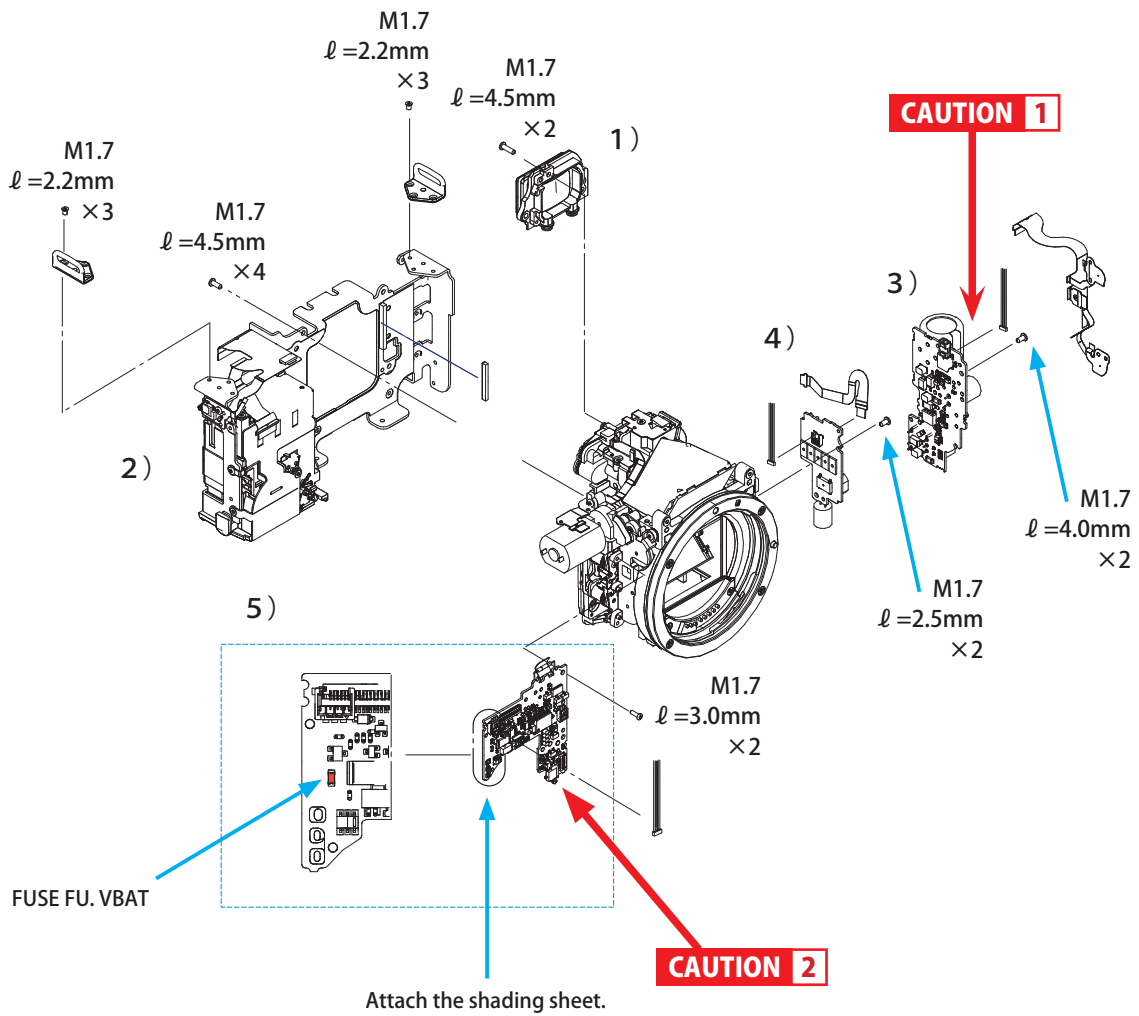

Fig. 088 Removal of the Main Base Plate Ass'y, Flash PCB, ASD PCB, and MD PCB

<Disassembly Procedures>

1) Removal of Eyepiece Cover Ass'y

Remove two screws and the Eyepiece Cover Ass'y.



Fig. 089

2) Removal of Main Base Plate Ass'y

(1) Remove four screws.

(2) Unsolder three comb-like teeth on the main battery contact and the comb-like teeth on the lithium date battery.

(3) Remove the flex connector. Raise the attached part of the FPC and remove the Mirror Box Ass'y.

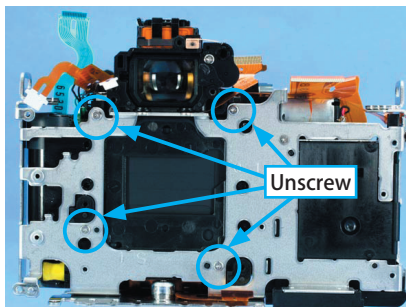

Fig. 090

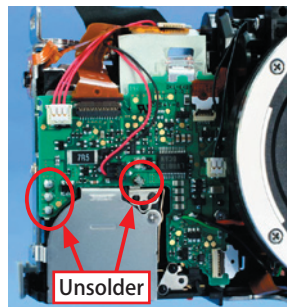

Fig. 091

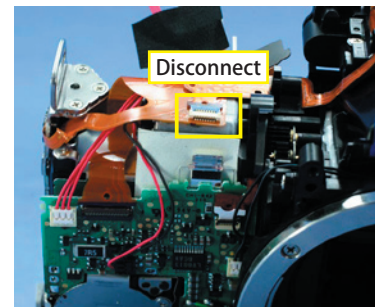

Fig. 092

3) Removal of the Flash PCB Ass'y and Flash FPC

(1) Remove the connector at one position from the MD PCB, weaken the adhesive on the Flash FPC with alcohol, raise the two positions of the switch, and then remove the Flash FPC.

(2) Remove two screws and the Flash PCB Ass'y.

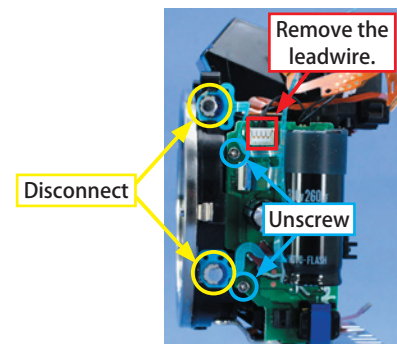

Fig. 093

CAUTION 1 Solder to the Flash PCB Ass'y at the position shown in Fig. 094.

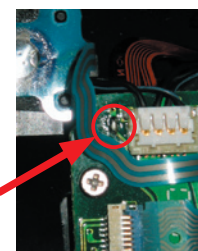

Fig. 094

- 4) Removal of the ASD PCB Ass'y and ASM FPC
 (1) Remove the FPC, connector, and connector with lead wire from the back of the PCB (inside) at one position each (Disassemble if necessary).
 (2) Remove two screws and the ASD PCB Ass'y.

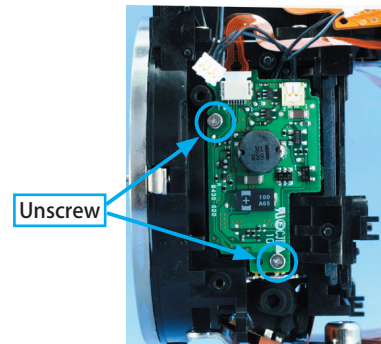

Fig. 095

- 5) Removal of the MD PCB Ass'y
 (1) Remove the lead wire with connector.
 (2) Unsolder the three lead wires (green /black/ red).
 (3) Remove the flex connector at two positions.
 (4) Remove two screws and the MD PCB Ass'y.

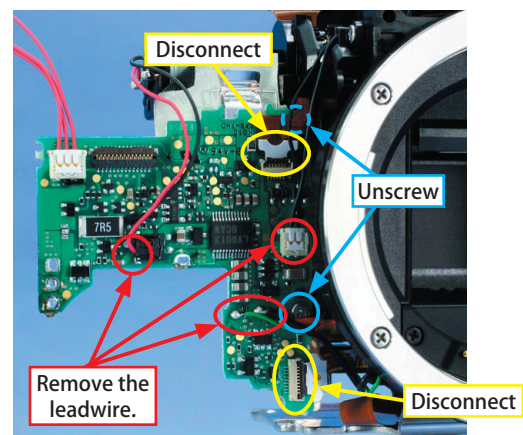

Fig. 096

<Reassembly Cautions>

- 1) The MD PCB Ass'y
 Check whether the shielding tape is attached at the back of the MD PCB (inside) as shown in Fig. 097.

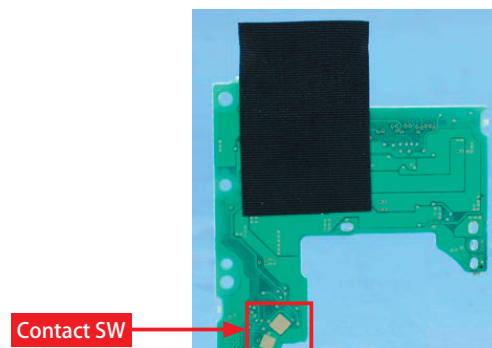

Fig. 097

CAUTION 2 There is a contact for date reset at the back of the MD PCB, so be careful not to bend the PCB and make sure that it is not bent when assembling.

2.5 Removal of the Mirror Box Ass'y, Shutter Ass'y, and Finder Unit

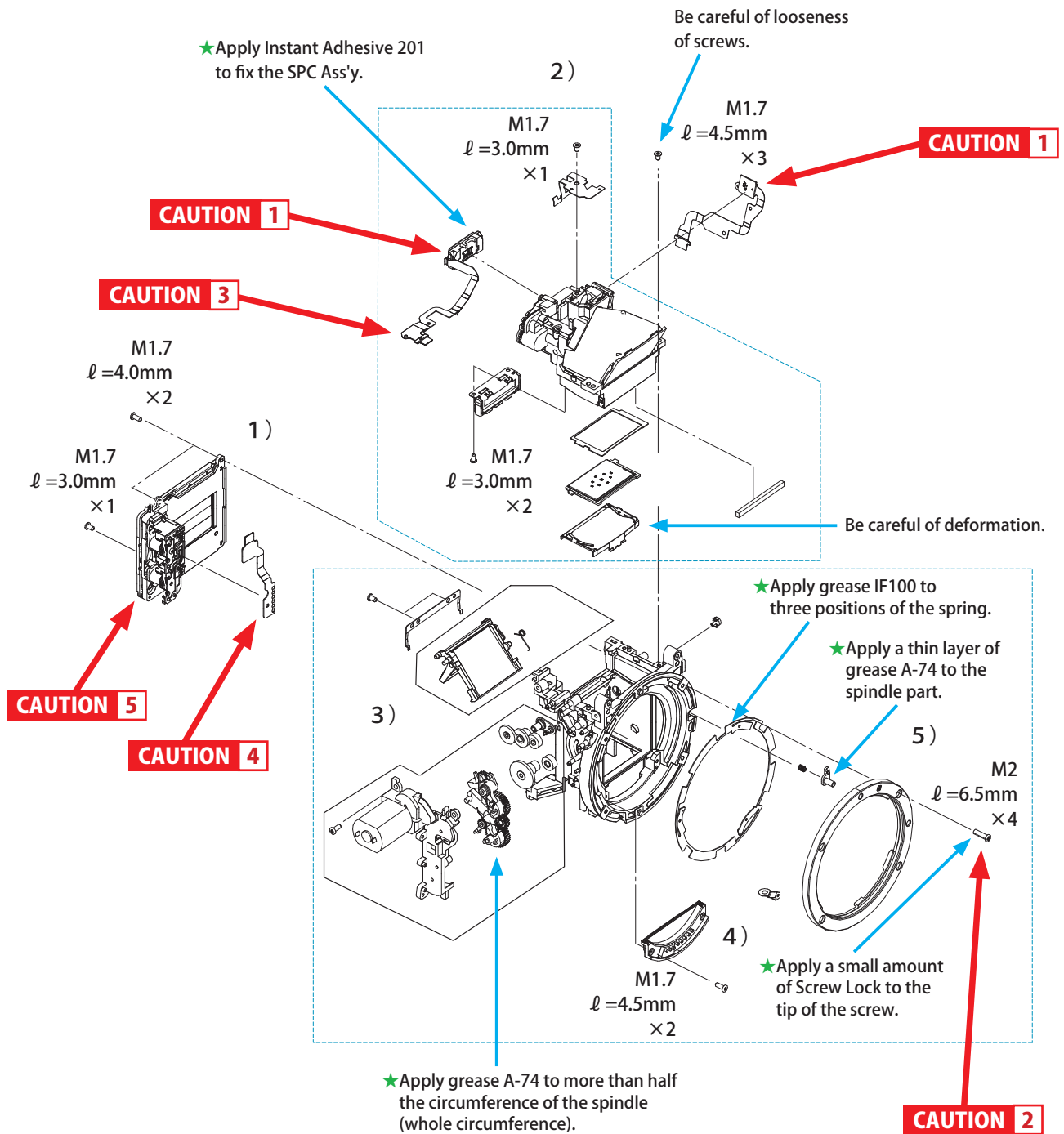

Fig. 098 Removal of the Mirror Box Ass'y, Shutter Ass'y, and Finder Unit

<Disassembly Procedures>

- 1) Removal of the Shutter Ass'y and Shutter FPC.
Remove three screws and the Shutter Ass'y.

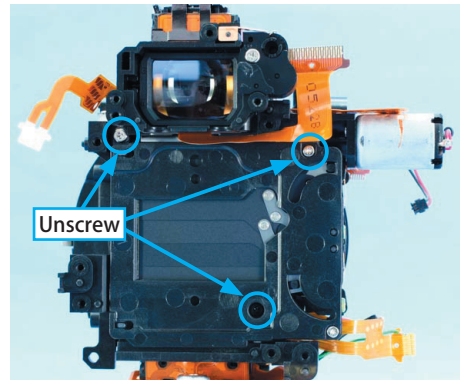

Fig. 099

- 2) Removal of the Finder Unit
 - (1) Remove the flex connector at three positions.
 - (2) Remove the lead wires temporarily in order to work efficiently.
 - (3) Remove three screws and the Finder Unit.

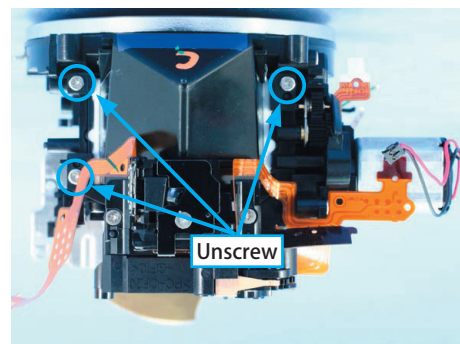

Fig. 100

Disassembly of Finder Unit

- (1) Remove the SI FPC Ass'y with a pair of tweezers.
- (2) Remove a screw and the SPC Holder.
- (3) Remove the Exposure Processing FPC Ass'y with a pair of tweezers.
- (4) Remove the ILC Ass'y, being careful not to damage the two screws.

CAUTION 1 After SI Ass'y and AE Sensor FPC are removed, positioning adjustment needs to be performed. Be careful.

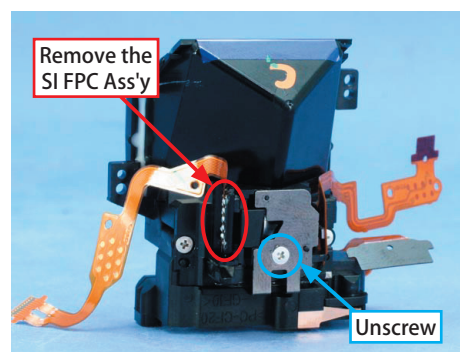

Fig. 101

3) Removal of the Mirror Box Ass'y

- (1) Remove two screws to remove the Mirror Ass'y and remove the metal fitting.
- (2) Remove the Mirror Spring and remove the Mirror Box Ass'y in the oblique direction.



Fig. 102

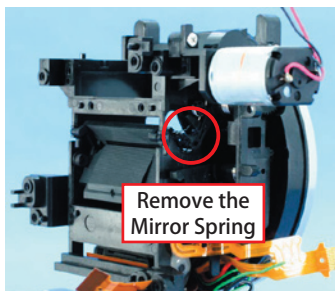

Fig. 103

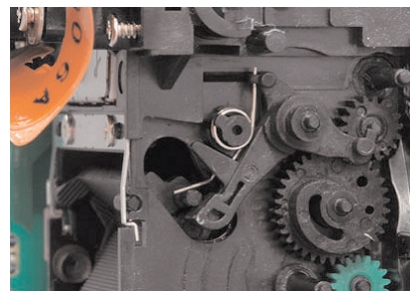

Fig. 104

4) Removal of the Mount Contact Ass'y

- (1) Rotate the shutter cam gear and make the mirror go up.
- (2) Remove three screws from the Motor Drive Ass'y and the Motor Unit and be careful not to lose the spring gear.
- (3) Remove the Shutter Charge Gear group.
- (4) Remove the MIF FPC.
- (5) Remove two screws and the Mount Contact Ass'y.

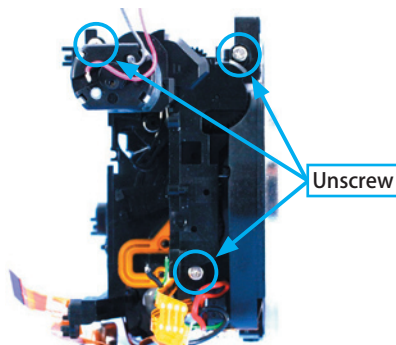

Fig. 105

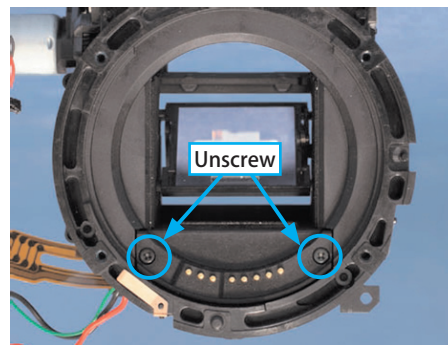

Fig. 106

* EOS KISS DIGITAL N is used for the sample picture.

5) Removal of the Mount

- (1) Remove four screws and the Mount.
- (2) Remove the mount spring, lens unlock lever, and the coil spring.

CAUTION 2 The screws to fix the Mount cannot be reused, so replace them with new ones when assembling and apply the specified expendable.

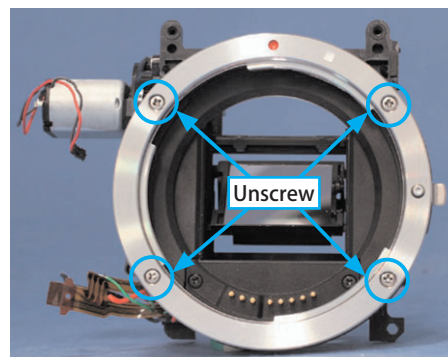

Fig. 107

* EOS KISS DIGITAL N is used for the sample picture.

<Reassembly Cautions>

1) The Finder Unit

(1)SI positioning is adjusted, so be careful not to touch the area circled in Fig. 108, and determine the position so as not to pinch the FPC.

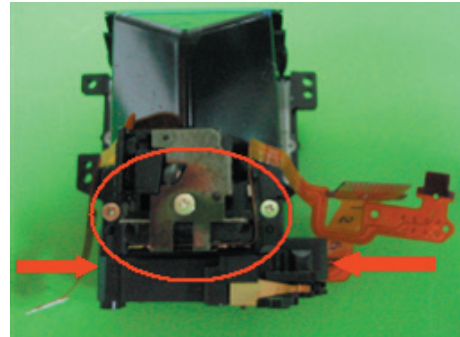

Fig. 108

(2)Screw in the order of the Fig. 109. (Screws are easy to be loose, so be careful.)

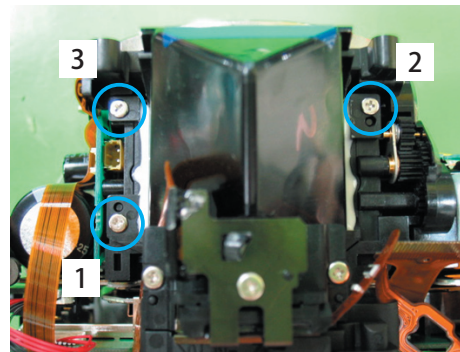

Fig. 109

(3)Handle the FPC as shown in Fig. 110 and make sure that it is positioned flat and insert to the end.

CAUTION 3 If the FPC is not handled correctly, the FPC might be broken or problems with pop up malfunctions or abnormal noise might occur, so handle it by routing the FPC when reassembling the Top Cover Ass'y.

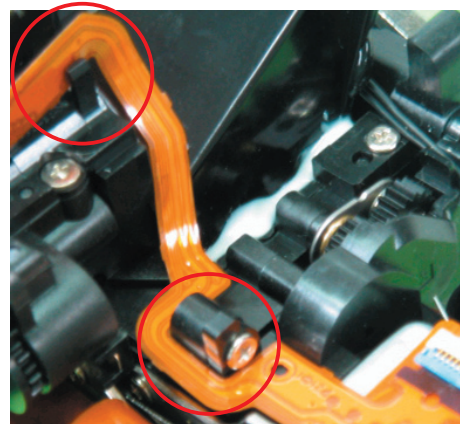

Fig. 110

(4)Be careful not to insert the Door Switch FPC Ass'y at an angle and assemble it at the position shown in Fig. 111.

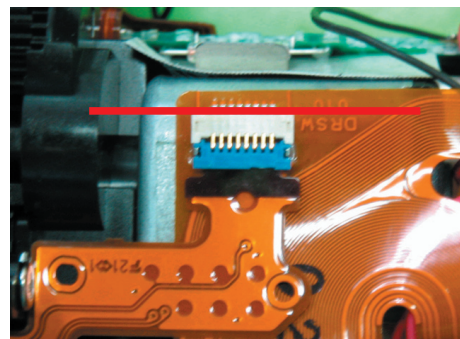

Fig. 111

(5) Assemble the FPC at three positions correctly.

CAUTION 4 If the Shutter FPC is inserted at an angle, the flash will not fire and charging malfunctions occur, so be careful.

(6) Route the lead wires shown in the Fig. 112 and handle the wire in order not to cover the gear or connector.

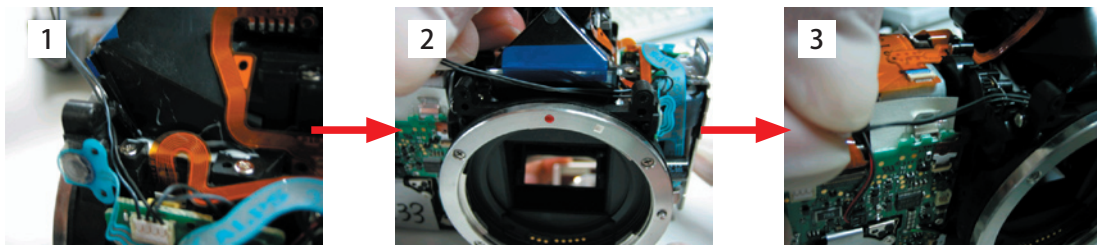

Fig. 112

2) The Mirror Box Ass'y

Match the phase of the Shutter Gear Charge Unit as shown in Fig. 113 and reassemble.



Fig. 113

3) The Shutter Unit

Pull out the Shutter FPC to the MD PCB side (front side) as shown in Fig. 114 when reassembling the Shutter Unit.

CAUTION 5 Be careful not to touch the shutter curtains.

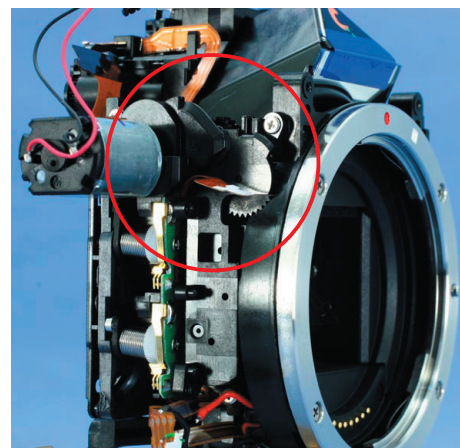

Fig. 114

2.6 Disassembly of the Main Base Plate Ass'y

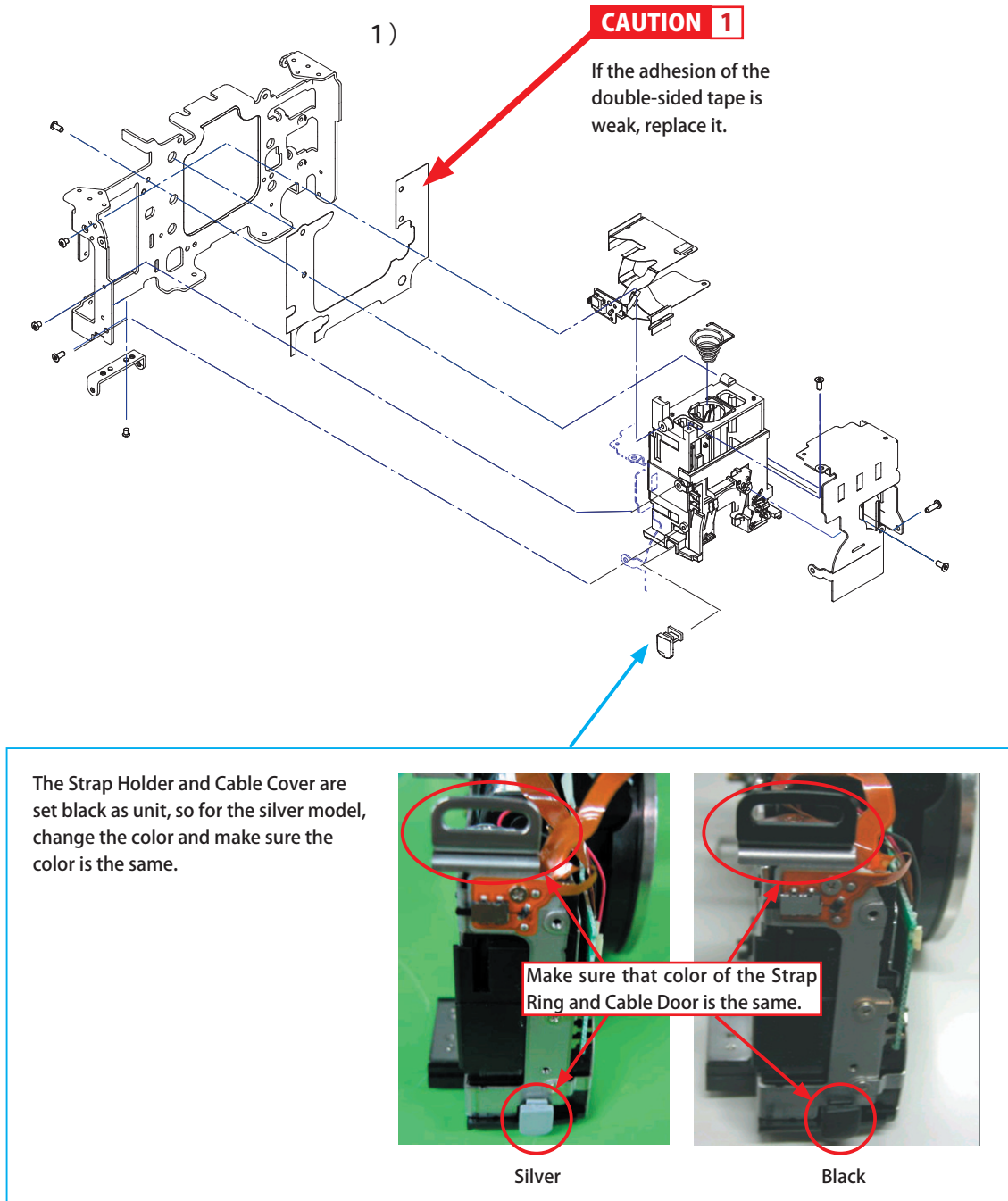

Fig. 115 Disassembly of the Main Base Plate Ass'y

<Disassembly Procedures>

1) Removal of the Battery Case Unit

- (1) Remove two screws and battery cover hinge.
- (2) Remove three screws from the side and one screw from the back to remove the battery part from the Main Base Plate Ass'y.
- (3) Remove three screws from the battery part to remove the Cable Cover and the Door Switch FPC Ass'y.

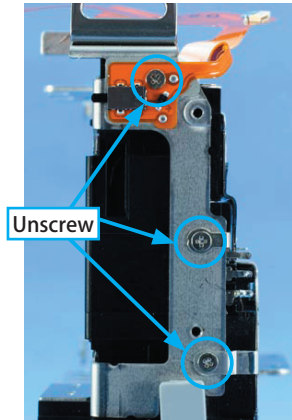

Fig. 116

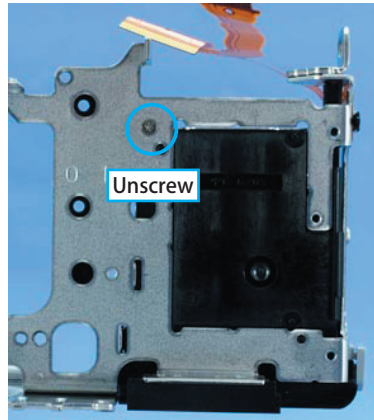

Fig. 117



Fig. 118

CAUTION 1 Do not touch the double-sided tape because it will get dusty. Attach as shown in Fig. 119.

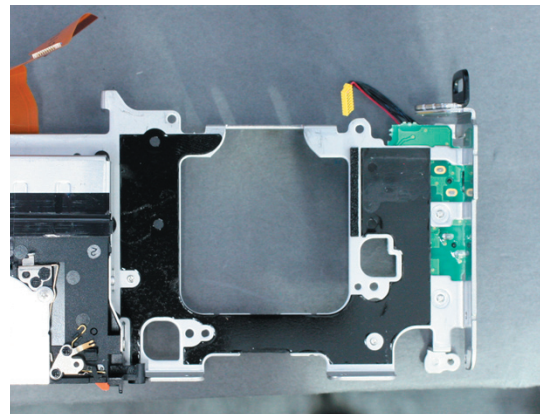

Fig. 119

2.7 Disassembly of the Front Cover Ass'y

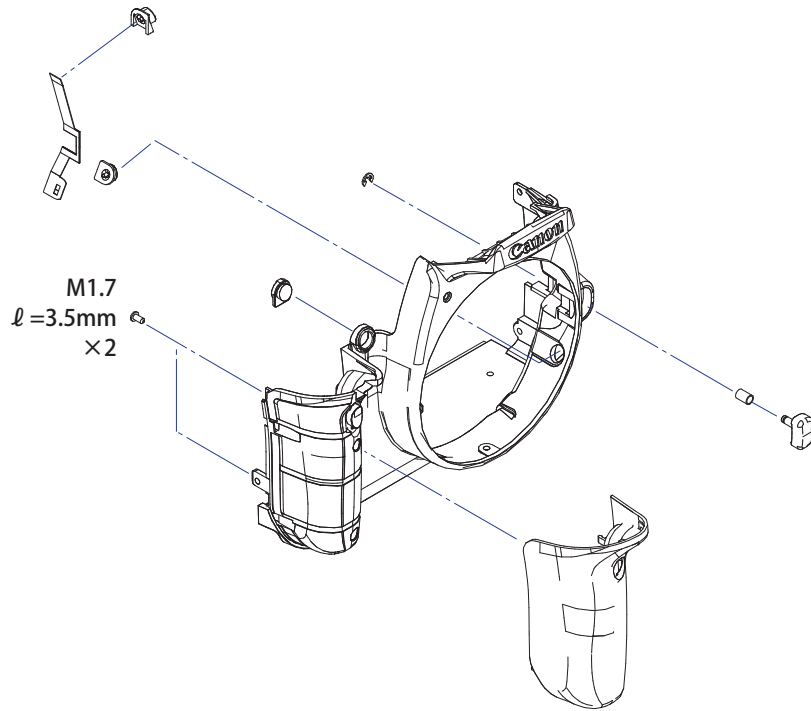

Fig. 120 Disassembly of the Front Cover Ass'y

2.8 Disassembly of the Top Cover Ass'y

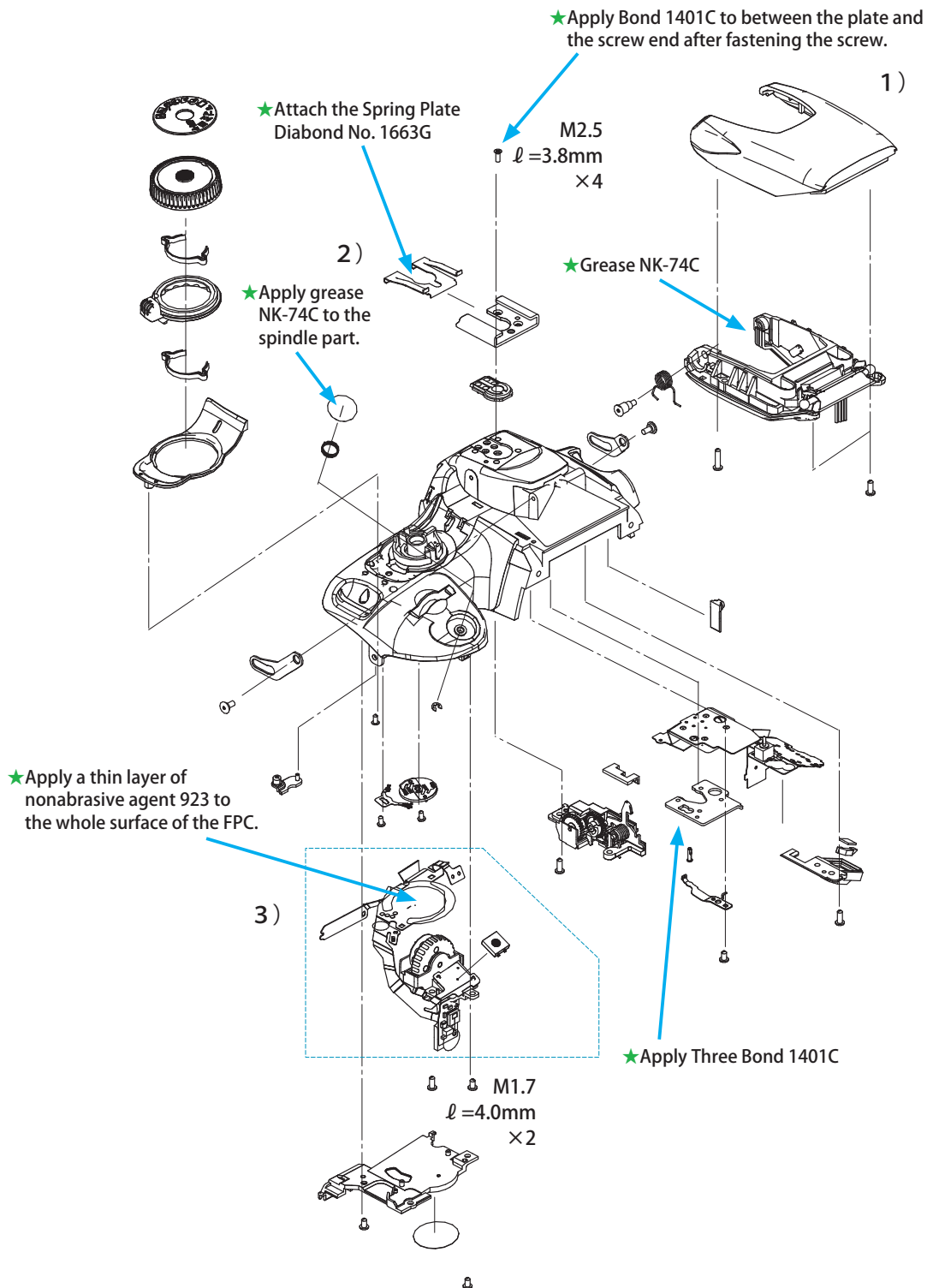

Fig. 121 Disassembly of the Top Cover Ass'y

<Disassembly Procedures>

1) Removal of the Flash Cover

Remove three screws and the Flash Cover by pressing the clasps at two positions with a pair of tweezers.

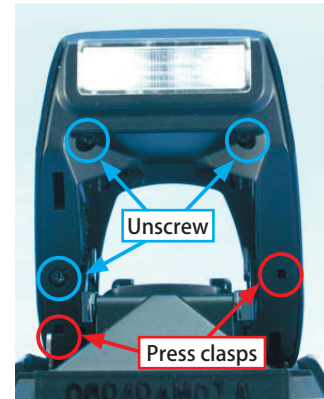

Fig. 122

2) Removal of the Accessory Shoe

- (1) Insert a pair of tweezers into the gap of the Accessory Shoe and remove the spring.
- (2) Remove four screws and the accessory shoe.

3) Removal of the Main Dial Ass'y and Release Switch

- (1) Remove five screws and the Dial Ass'y parts.
- (2) Unsolder comb-like teeth of the pop up switch and remove the Release Switch.

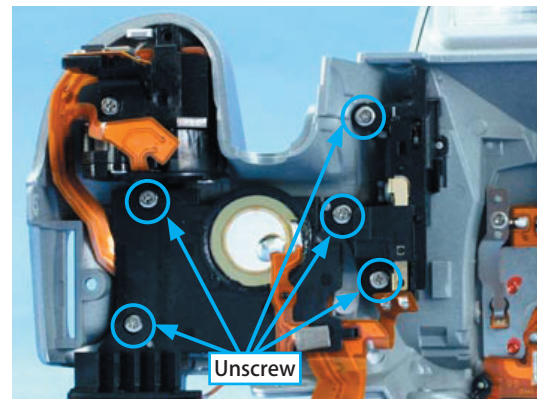

Fig. 123

<Reassembly Cautions>

Check that the insulating tape is attached as shown in Fig. 124.

Make sure that bond is applied to four screws for attaching the Accessory Shoe.

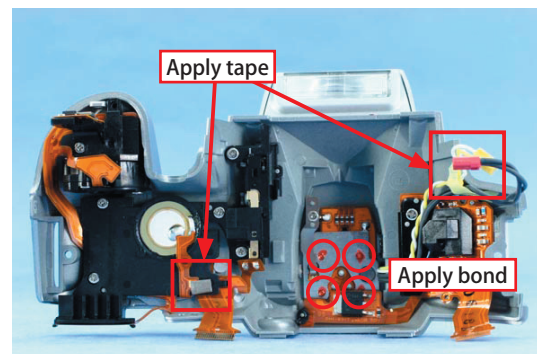

Fig. 124

2.9 Disassembly of the Back Cover Ass'y

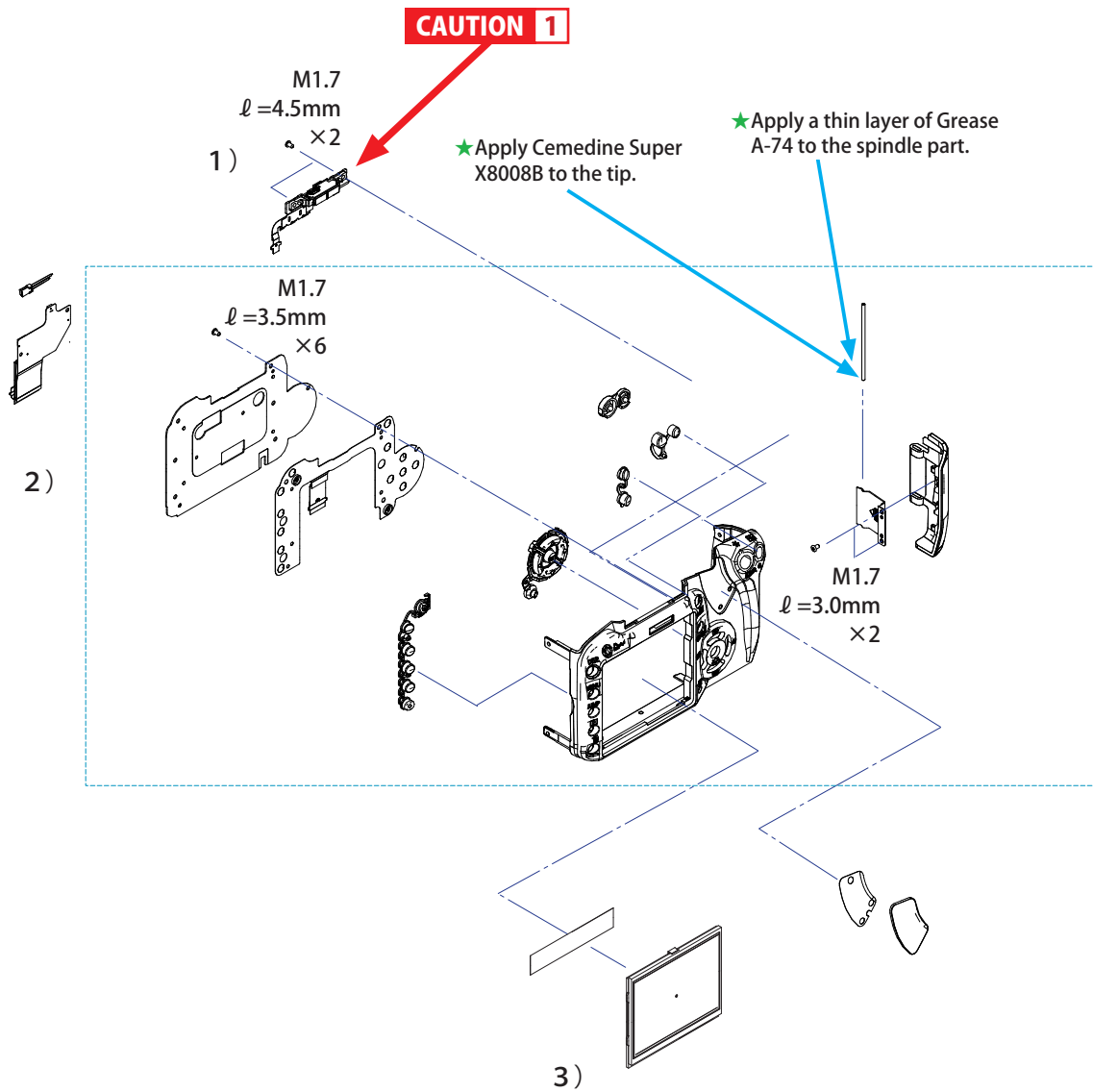

Fig. 125 Disassembly of the Back Cover Ass'y

<Disassembly Procedures>

1) Removal of the Face Detect PCB Ass'y.

Remove two screws and connector at one position and the Face Detect PCB Ass'y.

CAUTION 1 The bottom part of the Face Detect PCB Ass'y is easily damaged, so be careful when handling it.

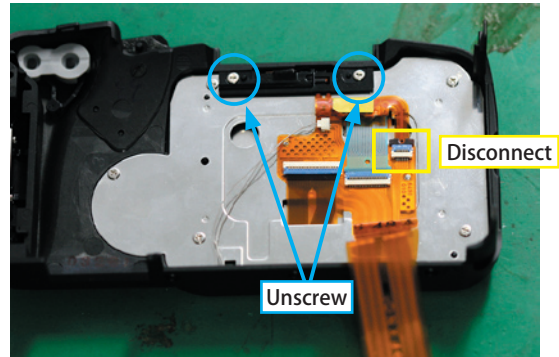

Fig. 126

2) Removal of the Back Cover FPC Ass'y

Remove the FPC at two positions, peel off the double-sided tape carefully, and then remove the Back Cover FPC Ass'y.

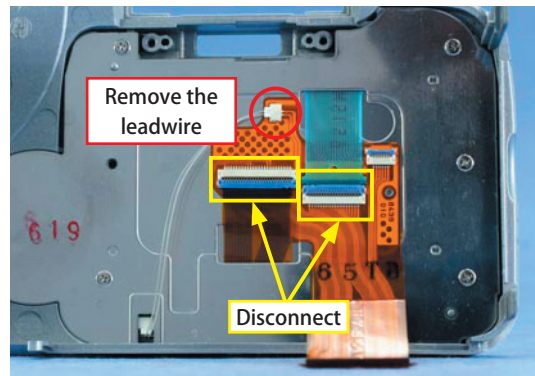

Fig. 127

3) Removal of the TFT LCD Ass'y

(1) Remove six screws and lift the Back Switch FPC Ass'y to remove all buttons and TFT LCD Ass'y.

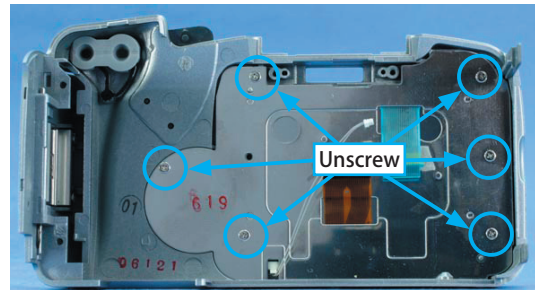

Fig. 128

(2) Weaken the adhesiveness of the border between the back cover and the TFT display window as indicated in red (Fig. 129) with solvent such as Ethanol and remove the TFT LCD Ass'y.



Fig. 129

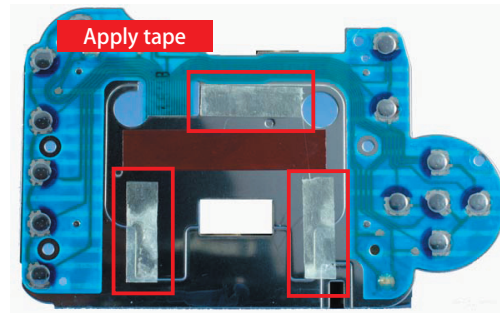

Fig. 130

Disassembly of the Back Cover Part

(1) Remove two screws.

(2) Remove bond and pull out the shaft upward to remove the CF Slot Cover Ass'y.



Fig. 131

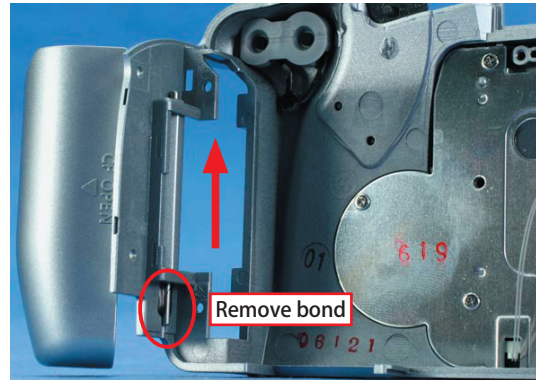

Fig. 132

Adjustments

Trademarks

The product names and company names described in this Service Manual are the registered trademarks of the individual companies.

Copyright

Canon Inc. retains the copyright to this Service Manual. Reproduction, publication (including on the World Wide Web), alteration, translation into another language, or other use of the data in whole or part, contained on this Service Manual without the written consent of Canon Inc. is prohibited.

CONTENTS

Adjustments	Page
1. REPAIR PREPARATIONS	1
1.1 Pre-Adjustment Notes.....	1
1.2 Tools List	1
1.3 Locally-Made Tools	3
2. MECHANICAL ADJUSTMENTS	4
2.1 Flange to Focal Plane Distance (FFD) Adjustment	4
2.2 Finder Focus Adjustment	8
3. ELECTRICAL ADJUSTMENTS	9
3.1 Adjustment Software Operation	9

1. REPAIR PREPARATIONS

1.1 Pre-Adjustment Notes

1) Firmware Upgrade

When the firmware version is upgraded, be sure to download a new version from the Canon site and make sure it is copied to a CF card without fail. Then, perform upgrade.

2) Before Starting the Adjustment

Before starting the adjustment, check the luminance of the EF-1 Multi Camera Tester or EF8000 with BM-3000. Also, check the angle of 3D chart with the angle gauge.

1.2 Tools List

Prepare the following tools required for adjustment.

1) Tools list

New	Name	Part No.	Purpose
	AF Lamp Box Unit	CY9-7122-000	To illuminate the AF chart
	Halogen Lamp (AC100V/250W)	CY9-7122-001	For replacement
	Heat Absorbing Filter	CY9-7122-002	Absorb heat wave of the lamp (replacement)
	STAND, AF CHART	CY9-7123-000	Chart stand for AF charts
	AF CHART, 3D	CY9-7119-000	3D Chart
	AF CHART, SINGLE-POINT	CY9-7119-001	AF Chart for 3D Chart
	AF STANDARD 9-POINT CHART	CY9-7119-006	AF adjustment
	AF CHART, 7 POINT, AGC	CY9-7119-005	AGC Chart
	EF-1 Multi Camera Tester (100V)	CY9-7116-100	"A" Light source
	(200V)	CY9-7116-200	"A" Light source
	Color viewer (5600K/100V)	DY9-2039-100	Electrical adjustment
	(5600K/115V)	DY9-2039-115	Electrical adjustment
	(5600K/220V)	DY9-2039-220	Electrical adjustment
	(5600K/240V)	DY9-2039-240	Electrical adjustment
	Color-bar chart	DY9-2002-000	Electrical adjustment (color adjustment)
	DC power source, regulated	Local Purchase	Electrical adjustment
	Mount Fastening Block	CY9-1547-000	Flange focal distance (FFD) adjustment
	Digital micrometer	CY9-7124-000	Flange focal distance (FFD) adjustment
	Digital micrometer stand	CY9-7124-001	Flange focal distance (FFD) adjustment
	Flat rod	CY9-7124-002	Flange focal distance (FFD) adjustment
	AF Tool Lens	CY9-1133-000	AF precision adjustment

New	Name	Part No.	Purpose
	Video light	Local Purchase	AF adjustment
	Tool Battery DR-700	CY9-7125-000	Inhibits voltage check
	Stand, AF/AE Positioning	CY9-7126-000	AF/AE Sensor Positioning
	Gauge, AF/AE Positioning	CY9-7126-001	AF/AE Sensor Positioning
	Light Box, AF/AE Positioning	CY9-7126-002	AF/AE Sensor Positioning
	Luminance Meter	CY9-7052-001	EF-1 Multi-camera Tester Calibration
	Focusing Rail	CY9-1139-000	AF Adjustment
	Screw	CY9-1139-001	AF Adjustment
	Flash meter	Local Purchase	Metering adjustment
	Tripod	Local Purchase	
	Multimeter	Local Purchase	Voltage reading
	C12 filters (2 ea.)	CY9-1546-000	White balance adjustment
	Luminance Meter BM-3000	CY9-7052-000	Multi-camera tester calibration
	Collimator (f=500mm) (100V)	CY9-7057-000 (100)	Finder Focus Adjustment
	(120V)	CY9-7057-000 (120)	Finder Focus Adjustment
	(200V)	CY9-7057-000 (200)	Finder Focus Adjustment
	(240V)	CY9-7057-000 (240)	Finder Focus Adjustment

2) Charts and Locally-Made Tools

New	Name	Part No.	Purpose
	SI Chart (Included in Appendix)	Local Fabrication	SI Position Check
	Inhibits voltage Load Resistor	Local Fabrication	Inhibits voltage check

3) Other Products for Testing

New	Name	Part No.	Purpose
	EF 50mm f/1.8 II	—	Camera operations, adjustments, production lens checking
	Speedlite (380EX, 550EX, or other E-TTL model)	—	Flash metering adjustment
	Clean Booth	CY9-7120-000	Cleaning
	Lupe (Dust check)	CY9-1132-000	Cleaning
	Battery Checker	CY9-7121-000	BATTERY PACK USABILITY DETERMINATION
	ACK-700	—	POWER SUPPLY

1.3 Locally-Made Tools

1) SI Adjustment Chart

This chart, which is included in the Appendix, is used to position the superimposing element.

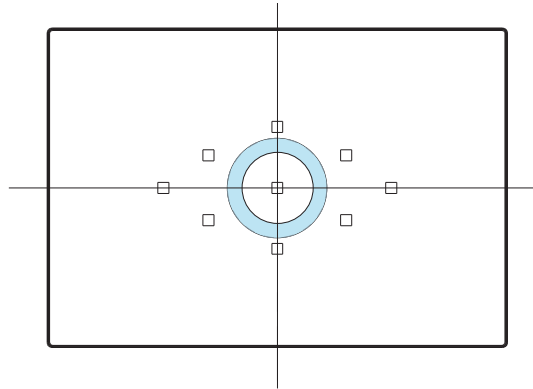

Fig. 001

2) Tool Battery

The tool battery is the same as the tool battery for the EOS 10D and 20D. The total internal resistance should be 0.4Ω .



Fig. 002

2. MECHANICAL ADJUSTMENTS

2.1 Flange to Focal Plane Distance (FFD) Adjustment

CAUTION

- The adjustment procedure is same as that of EOS-1D series
- FFD adjustment is required when replacing the mirror box ass'y or the CMOS sensor ass'y.
- It is also required when images blurred on one side occur due to some impact.

⟨Purpose⟩

The FFD is the distance between the lens mount reference plane and the CMOS sensor plane. It cannot be measured directly by service; therefore, measure the distance from the mount plane to CMOS mounting washer plane (washer included) to adjust the FFD.

⟨Service Parts⟩

Mirror box ass'y: Compensation washers are not attached as before.

CMOS sensor ass'y: Offset values based on the specification are written.

⟨Specifications⟩

Mirror box ass'y replacement: Set the distance from the lens mount to the CMOS sensor installation surface to same distance as before mirror box ass'y replacement.

CMOS sensor ass'y: Add or subtract the CMOS sensor ass'y compensation amount to/from the difference calculated by subtracting the original distance between the lens mount and the CMOS installation surface (washer included) from the specified distance. Select the washer that meets calculated value to bring the FFD within the specification.

Reference (FFD): The dimension from the lens mount surface to the imaging surface i.e. the FFD (Flange to focal plane distance) is $44.00 \pm 0.02\text{mm}$.

⟨Tools⟩

- | | | | |
|----------------------|--------------|------------------------|--------------|
| • Digital micrometer | CY9-7124-000 | • Stand | CY9-7124-001 |
| • Measuring terminal | CY9-7124-002 | • Mount Fastening Tool | CY9-1547-000 |

⟨Preparation⟩

- Place the mount fastening block on the digital micrometer, and place the measuring tip on the mount reference plane. Reset the meter to "0".

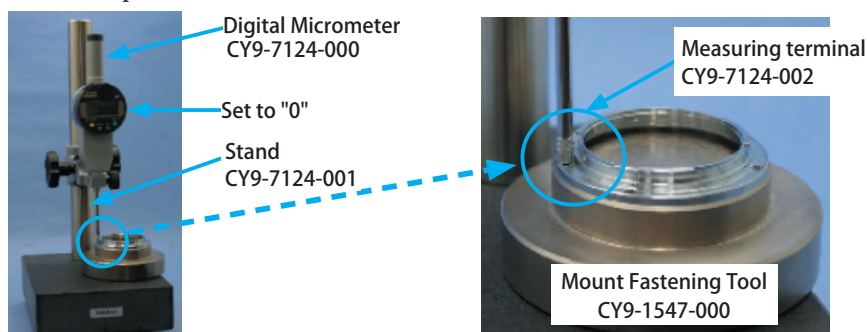

Fig. 003 Set up

〈Adjustment Procedure〉

1) When replacing CMOS sensor ass'y (Using the original mirror box)

CAUTION

Service parts are set to 42.930mm at the factory, and their image units are adjusted. Each offset data is attached to the parts. Therefore, based on the 42.930mm standard, the offset needs to be added or subtracted to calculate the final distance. Then, finally select washer that meet calculated distance.

(1) Measuring the CMOS sensor position

Measure the distance from the mount surface to the following three points.

Ex.) P1: 42.074mm
 P2: 42.455mm
 P3: 42.756mm

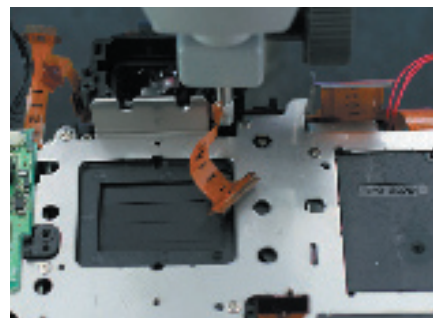

Fig. 004

(2) Offset washer determination (Standard distance: 42.93mm)

The difference between the standard distance and the measured distance for each point (1) is the washer thickness required at that point. (Do not bond washers in place.)

P1: $42.930 - 42.074 = 0.856$

P2: $42.930 - 42.455 = 0.475$

P3: $42.930 - 42.756 = 0.174$

(3) CMOS sensor ass'y Offset

The CMOS sensor ass'y is marked with the offset values (difference from 43.30mm) for each point. When installing the CMOS sensor, use the indicated washers, but do not bond the washers in place.

Ex.) P1 (upper right) : $0.856 + 0.02 = 0.876$

P2 (lower right) : $0.475 + 0.05 = 0.525$

P3 (left) : $0.174 - 0.069 = 0.105$

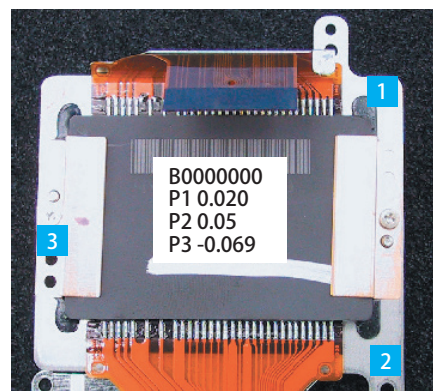

Fig. 005

- (4) Tighten the three CMOS sensor ass'y screws uniformly.

CB2-0682-000 (XXX) Detail

	A	SIZE
	0.03mm	(003)
	0.05mm	(005)
	0.08mm	(008)
	0.10mm	(010)
	0.12mm	(012)
	0.15mm	(015)
	0.18mm	(018)
	0.20mm	(020)

Fig. 006

2) When replacing the mirror box ass'y (Using the original CMOS sensor ass'y)

CAUTION

As the washer offsets for the CMOS sensor ass'y are unknown, select washer offsets and insert the washer to approximate the distance from mount surface of mirror box to image sensor installation surface (washer included) on the camera being repaired.

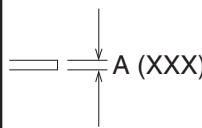
- (1) Before replacing the mirror box, remove the CMOS sensor ass'y, and measure the existing dimension from the mount surface to the image sensor installation surface (with washer) at the three points.
 - (2) After replacing the mirror box, measure the distance from the mount surface to the image sensor installation surface (three points). Select and attach washers to make the distance the same as before replacement.
- Ex.) When the existing measured value (distance from mount surface to CMOS sensor installation surface) is 44.75mm, 0.1mm washer is attached, and the measured value after replacement is 44.85.

3) When replacing both the Mirror Box Ass'y and CMOS sensor ass'y

CAUTION

Mirror box ass'y service parts are factory-adjusted to standard size (42.930mm), and the correction is marked on the parts. Therefore, the mirror boxes are adjusted to 42.930mm, and the offset correction is marked on the CMOS sensor unit. Follow the procedures in Adjustment Procedure 1).

(1) Measuring the CMOS sensor position

Measure the distance from the mount surface to the following three points.

Ex.) P1: 42.074mm

P2: 42.455mm

P3: 42.756mm

(2) Offset washer determination (Standard distance: 42.930mm)

The difference between the standard distance and the measured distance for each point (1) is the washer thickness required at that point. (Do not bond washers in place.)

P1: $42.930 - 42.074 = 0.856$

P2: $42.930 - 42.455 = 0.475$

P3: $42.930 - 42.756 = 0.174$

(3) CMOS sensor ass'y Offset

The CMOS sensor ass'y is marked with the offset values (difference from 43.20mm) for each point. When installing the CMOS sensor, use the indicated washers, but do not bond the washers in place.

Ex.) P1 (upper right) : 0.02

P2 (lower right) : 0.05

P3: (left) : -0.069



Fig. 007

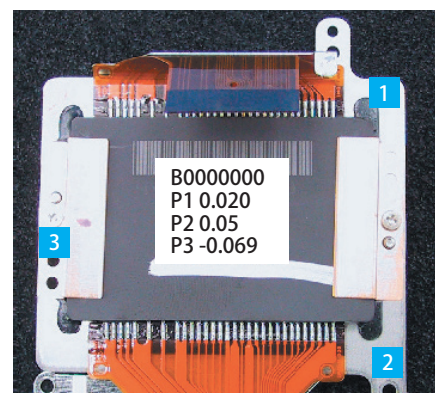

Fig. 008

(4) Tighten the three CMOS sensor ass'y screws uniformly.

CB2-0682-000 (XXX) Detail

	A	SIZE
	0.03mm	(003)
	0.05mm	(005)
	0.08mm	(008)
	0.10mm	(010)
	0.12mm	(012)
	0.15mm	(015)
	0.18mm	(018)
	0.20mm	(020)

Fig. 009

2.2 Finder Focus Adjustment

CAUTION

Be sure to perform the Finder Focus Adjustment after the FFD Adjustment is completed.

〈Purpose〉

To fit the position of CMOS sensor plane and the viewfinder focus point

〈Specifications〉

The center of the infinity mark must be positioned within the 1.5 index line widths of the index line as shown below.

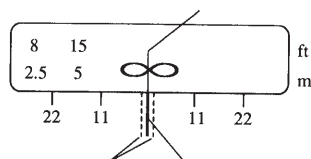

Fig. 10 Focusing Scale Alignment

〈Tools〉

- Magnifier AD-S, Angle finder C, Finder accessories.
- Lens of 100 mm focal length or less is desirable.
- General purpose 500mm collimator

〈Preparation〉

- 1) Without the lens attached to the camera, turn the diopter adjustment dial of the camera to adjust the AF frame to be at the center of the viewfinder.
- 2) Attach the magnifier to the camera eyepiece and adjust the diopter of the magnifier. (Perform without the lens attached.)

〈Adjustment Procedure〉

- 1) Look through an object that is located at least 250m away (such as lightning rod or chimney) and turn the manual ring to find the position that gives the clearest view of the object.
- 2) Check if the center of the infinity mark is positioned within the 1.5 index line equivalent widths. If not, replace the focus washer.

* When a collimator is used, select the focus washer that gives the clearest view of the collimator scale.

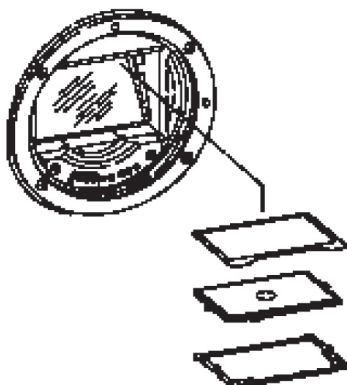

Fig. 011 Focusing Washer Replacement

3. ELECTRICAL ADJUSTMENTS

3.1 Adjustment Software Operation

1) Service Parts

OS: Windows 2000, Windows XP

CPU: Pentium III, 800MHz or better

RAM: 256 MB or more required

Display: 800 × 600 dots required, 1024 × 768 dots recommended

Hard disk space: Approx. 50 MB required

2) Operation

Basically, the adjustment software can be operated with the mouse, cursor keys, space bar, and enter key. Follow the instructions appearing in the message area.

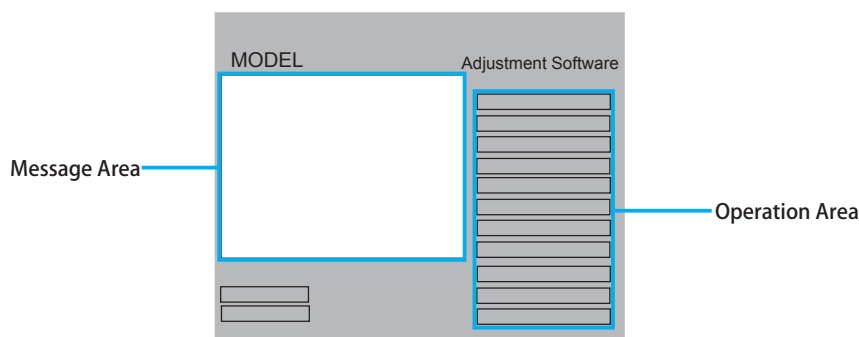

Fig. 012 Menu Display

3) Demo Mode

The adjustment software operations can be checked without connecting the camera. When starting up the adjustment software, press the "DEMO" button..

4) HTML Help

When starting up the adjustment software, the help window will be displayed automatically. The help window is interlocked with the adjustment software. The Help window corresponding to the selected adjustment will be displayed when Help is clicked.

Press Close to close the help window.

The Help window can be printed by clicking on the printer icon.

5) Installation and Adjustment Procedures

See the HELP section of the Adjustment Software for details.

6) Miscellaneous

If there are problems with the Adjustment Software, contact your regional technical support manager.

Parts Catalog

Canon

**EOS KISS DIGITAL X
EOS DIGITAL REBEL XTi
EOS 400D DIGITAL**

**REF. NO. C12-6151, 2
C12-6153, 4
C12-6155, 6**

PARTS CATALOG

CANON DIGITAL CAMERA EOS KISS DIGITAL X
EOS DIGITAL REBEL XTi
EOS 400D DIGITAL

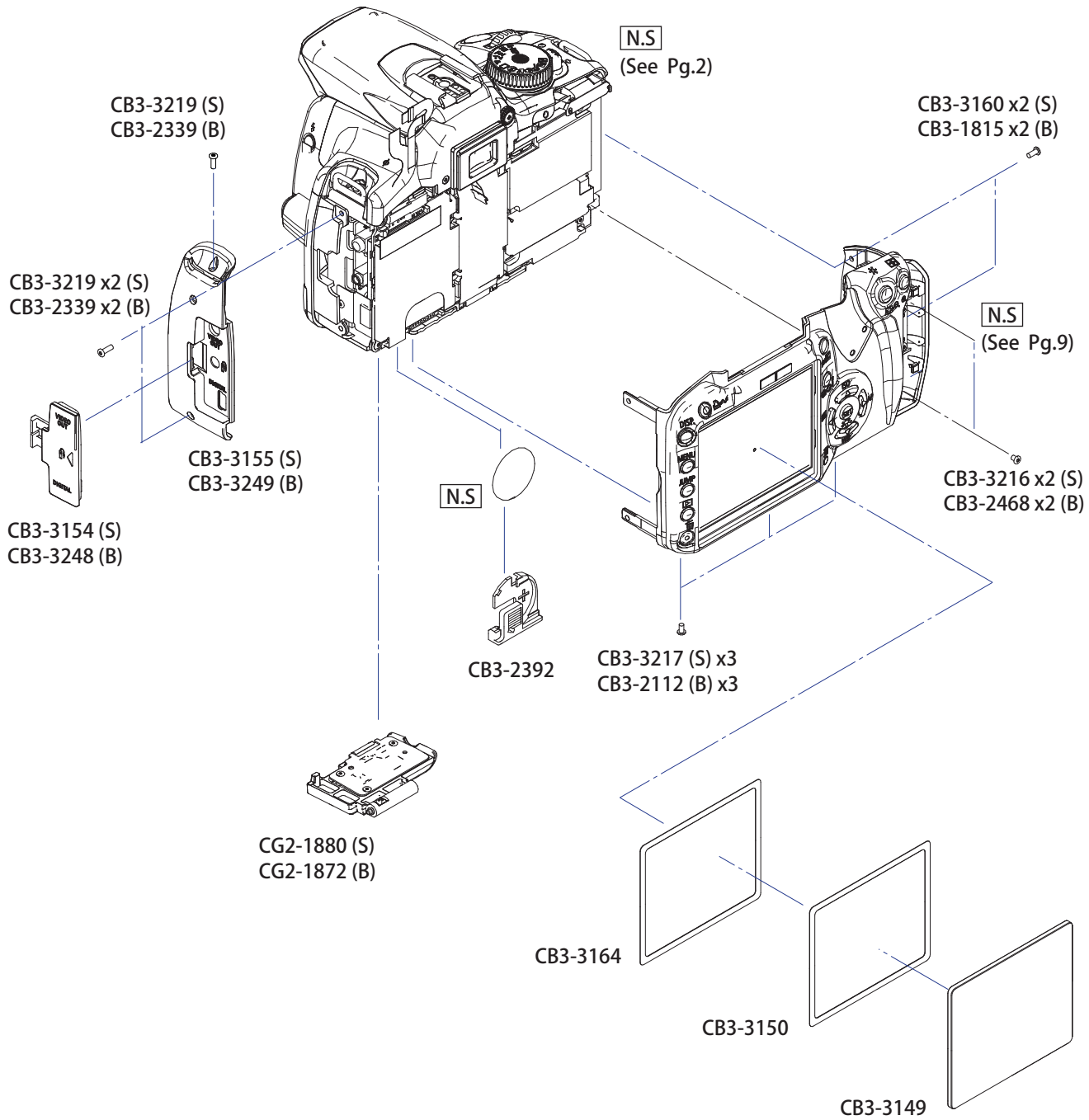

P A R T S L I S T

REF. NO. C12-6151, 2
 C12-6153, 4
 C12-6155, 6

NEW	PARTS NO.	CLASS	QTY	DESCRIPTION
	CB3-1815-000 000	C	2	SCREW
	CB3-2112-000 000	F	3	SCREW
*	CB3-2339-000 000	C	3	SCREW, M3X5(BLACK)
	CB3-2392-000 000	C	1	CASE, BATTERY
	CB3-2468-000 000	C	2	SCREW, M3X2(BLACK)
*	CB3-3149-000 000	B	1	WINDOW, TFT DISPLAY
*	CB3-3150-000 000	B	1	TAPE, DOUBLE SIDE, TFT
*	CB3-3154-000 000	B	1	CAP, TERMINAL(SILVER)
*	CB3-3155-000 000	B	1	COVER, SIDE(SILVER)
*	CB3-3160-000 000	C	2	SCREW, M3X4(SILVER)
*	CB3-3164-000 000	C	1	HOLDER, TFT SHADE
*	CB3-3216-000 000	C	2	SCREW, M3X2(SILVER)
*	CB3-3217-000 000	C	3	SCREW, M3X3(SILVER)
*	CB3-3219-000 000	C	3	SCREW, M3X6(SILVER)
*	CB3-3248-000 000	B	1	CAP, TERMINAL(BLACK)
*	CB3-3249-000 000	B	1	COVER, SIDE(BLACK)
*	CG2-1872-000 000	B	1	COVER ASS'Y, BATTERY(BLACK)
*	CG2-1880-000 000	B	1	COVER ASS'Y, BATTERY(SILVER)

CANON DIGITAL CAMERA EOS KISS DIGITAL X
EOS DIGITAL REBEL XT
EOS 400D DIGITAL

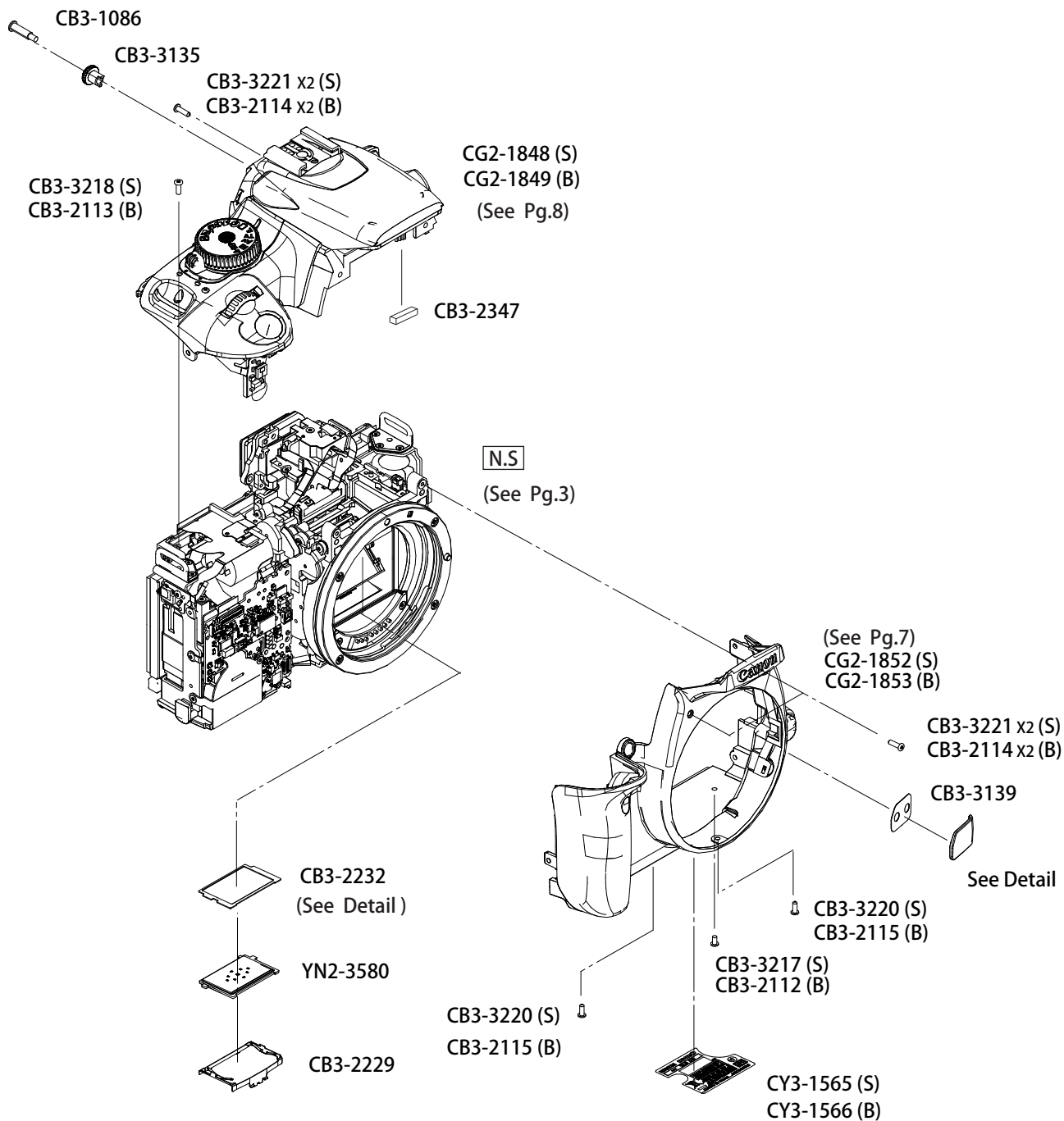

CB3-2232-000 (XXX) Detail

	A	SIZE
	0.05mm	(005)
	0.10mm	(010)
	0.15mm	(015)
	0.20mm	(020)
	0.25mm	(025)
	0.30mm	(030)
	0.35mm	(035)
	0.40mm	(040)
	0.45mm	(045)
	0.50mm	(050)

Detail

	SILVER	BLACK
EOS KISS DIGITAL X	CB3-3138	CB3-3238
EOS DIGITAL REBEL XT	CB3-3230	CB3-3231
EOS 400D DIGITAL	CB3-3232	CB3-3233

P A R T S L I S T

REF. NO. C12-6151, 2
 C12-6153, 4
 C12-6155, 6

NEW	PARTS NO.	CLASS	QTY	DESCRIPTION
	CB3-1086-000 000	F	1	SCREW
	CB3-2112-000 000	F	1	SCREW, M3X3(BLACK)
	CB3-2113-000 000	F	1	SCREW, M3X4.5(BLACK)
	CB3-2114-000 000	F	4	SCREW, M3X6(BLACK)
	CB3-2115-000 000	F	2	SCREW, M3X4.5(BLACK)
	CB3-2229-000 000	C	1	HOLDER, FOCUSING SCREEN
	CB3-2232-000 (XXX)	C	1	PLATE, FINDER FOCUS ADJUSTMENT
	CB3-2347-000 000	C	1	GASKET
*	CB3-3135-000 000	C	1	DIAL, DIOPTER ADJUSTING
*	CB3-3138-000 000	C	1	PLATE, NAME JAPAN(SILVER)
*	CB3-3139-000 000	B	1	TAPE, DOUBLE SIDE, NAME
*	CB3-3217-000 000	C	1	SCREW, M3X3(SILVER)
*	CB3-3218-000 000	C	1	SCREW, M3X4.5(SILVER)
*	CB3-3220-000 000	C	2	SCREW, M3X4.5(SILVER)
*	CB3-3221-000 000	C	4	SCREW, M3X6(SILVER)
*	CB3-3230-000 000	C	1	PLATE, NAME USA(SILVER)
*	CB3-3231-000 000	C	1	PLATE, NAME USA(BLACK)
*	CB3-3232-000 000	C	1	PLATE, NAME EURO(SILVER)
*	CB3-3233-000 000	C	1	PLATE, NAME EURO(BLACK)
*	CB3-3238-000 000	C	1	PLATE, NAME JAPAN(BLACK)
*	CG2-1848-000 000	B	1	COVER ASS'Y, TOP(SILVER)
*	CG2-1849-000 000	B	1	COVER ASS'Y, TOP(BLACK)
*	CG2-1852-000 000	B	1	COVER ASS'Y, FRONT(SILVER)
*	CG2-1853-000 000	B	1	COVER ASS'Y, FRONT(BLACK)
*	CY3-1565-000 000	C	1	LABEL, BODY NUMBER(SILVER)
*	CY3-1566-000 000	C	1	LABEL, BODY NUMBER(BLACK)
*	YN2-3580-000 000	B	1	PLATE, FOCUSING SCREEN

P A R T S L I S T

REF. NO. C12-6151, 2
 C12-6153, 4
 C12-6155, 6

NEW	PARTS NO.	CLASS	QTY	DESCRIPTION
	CB2-0682-000 (XXX)	C	3	WASHER, FB ADJ.
	CB3-2808-000 000	C	2	SCREW
*	CB3-3157-000 000	C	1	PLATE, TRIPOD SOCKET
*	CB3-3170-000 000	C	1	CASE, MAIN PCB SHIELD
*	CB3-3717-000 000	C	1	SHEET, NOISE PREVENTION
*	CG2-1840-000 000	C	1	PCB ASS'Y, I/F
*	CG2-1869-000 000	C	1	PCB ASS'Y, MAIN
*	CG2-1871-000 000	C	1	FPC ASS'Y, AF
*	CH2-8432-000 000	C	1	LEAD ASS'Y, MAIN-I/F
*	CY3-1567-000 000	B	1	CMOS SENSOR ASS'Y
	VD7-2241-501 000	C	1	FUSE
	WS1-6384-000 000	C	1	CONNECTOR, CF PIN
	XA1-3200-257 000	F	2	SCREW M2X2.5
	XA1-7170-167 000	F	4	SCREW, CROSS-RECESS, PH
	XA1-7170-257 000	F	2	SCREW, CROSS-RECESS, PH
	XA1-7170-307 000	F	2	SCREW, MACH. PANHEAD, M1.7X3
	XA4-9170-507 000	F	3	SCREW, CROSS-RECESS, PH
	XA4-9200-507 000	F	2	SCREW, CROSS-RECESS, PH S

CANON DIGITAL CAMERA EOS KISS DIGITAL X
EOS DIGITAL REBEL XT
EOS 400D DIGITAL

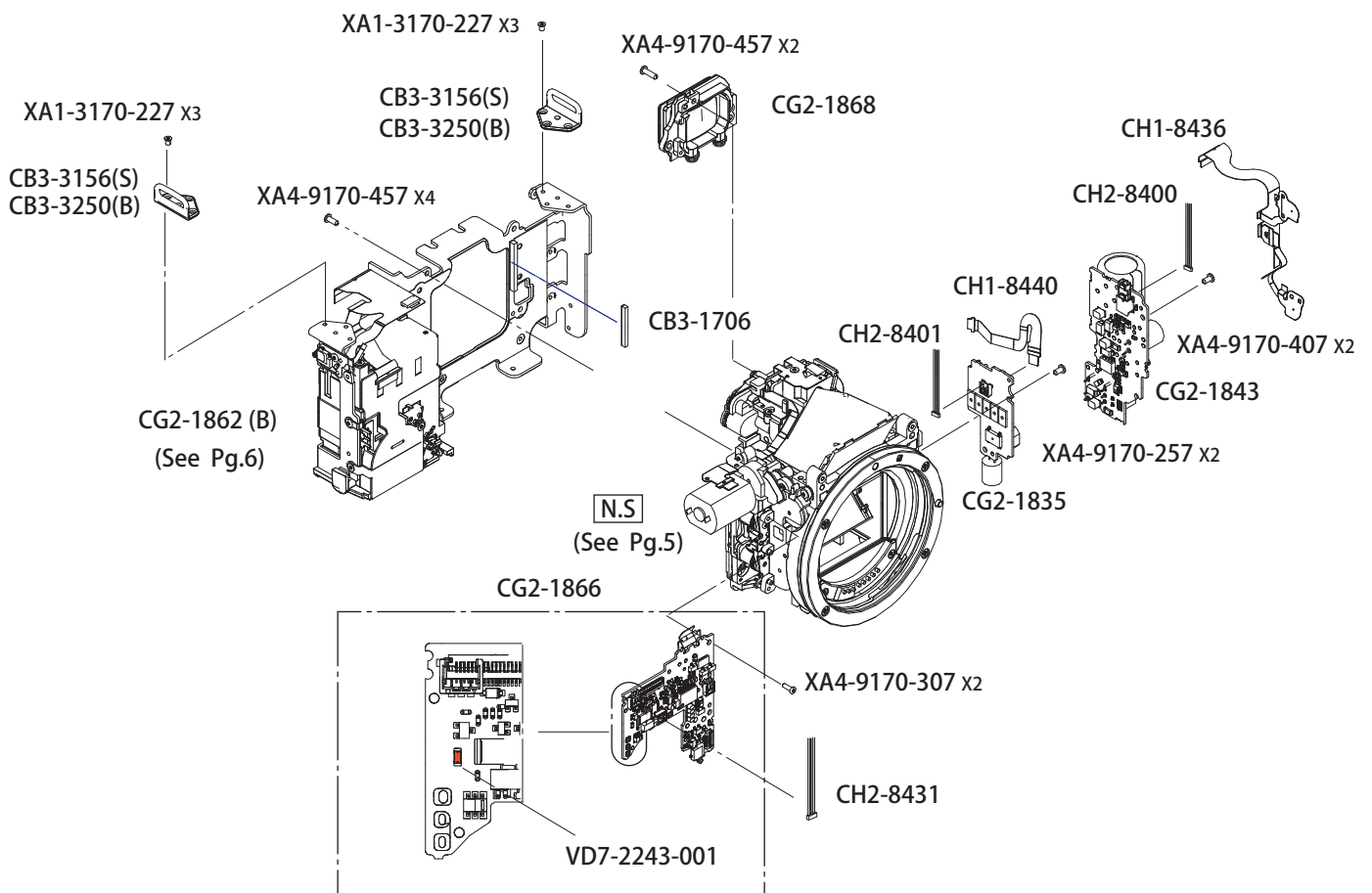

P A R T S L I S T

REF. NO. C12-6151, 2
 C12-6153, 4
 C12-6155, 6

NEW	PARTS NO.	CLASS	QTY	DESCRIPTION
	CB3-1706-000 000	C	1	CUSHION, MIRROR
*	CB3-3156-000 000	C	2	HOLDER, STRAP (SILVER)
*	CB3-3250-000 000	C	2	HOLDER, STRAP (BLACK)
*	CG2-1835-000 000	C	1	PCB ASS'Y, ACTIVE SWEEP DEVICE
*	CG2-1843-000 000	C	1	PCB ASS'Y, FLASH
*	CG2-1862-000 000	C	1	PLATE ASS'Y, MAIN BASE (BLACK)
*	CG2-1866-000 000	C	1	PCB ASS'Y, MD
*	CG2-1868-000 000	B	1	COVER ASS'Y, EYEPIECE
*	CH1-8436-000 000	C	1	FPC, FLASH
*	CH1-8440-000 000	C	1	FPC, ASM
*	CH2-8400-000 000	C	1	LEAD ASS'Y, MOTOR-FLASH
*	CH2-8401-000 000	C	1	LEAD ASS'Y, ACTIVE SWEEP DEVICE
*	CH2-8431-000 000	C	1	LEAD ASS'Y, MOTOR-MAIN
	VD7-2243-001 000	C	1	FUSE, LITTEL 0494003.NR
*	XA1-3170-227 000	F	6	SCREW, M1.7X2.2
	XA4-9170-257 000	F	2	SCREW, CROSS-RECESS, PH
	XA4-9170-307 000	F	2	SCREW, CROSS-RECESS, PH
	XA4-9170-407 000	F	2	SCREW, CROSS-RECESS, PH
	XA4-9170-457 000	F	6	SCREW, CROSS-RECESS, PH

CANON DIGITAL CAMERA EOS KISS DIGITAL X
EOS DIGITAL REBEL XT1
EOS 400D DIGITAL

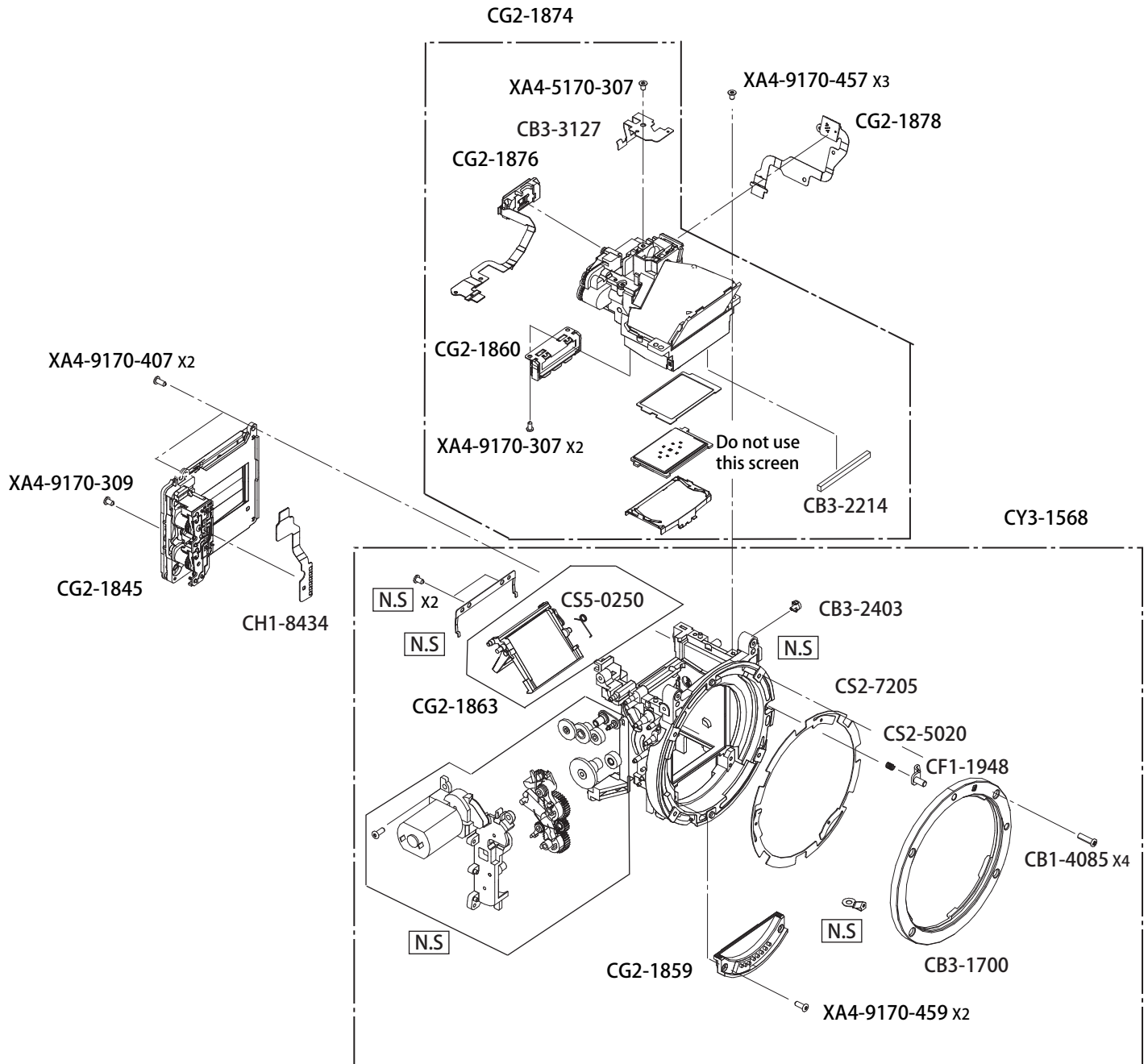

P A R T S L I S T

REF. NO. C12-6151, 2
 C12-6153, 4
 C12-6155, 6

NEW	PARTS NO.	CLASS	QTY	DESCRIPTION
	CB1-4085-000 000	C	4	SCREW, M2X6.5
	CB3-1700-000 000	C	1	MOUNT
	CB3-2214-000 000	F	1	CUSHION, MIRROR
	CB3-2403-000 000	C	1	STOPPER, SUB MIRROR
*	CB3-3127-000 000	C	1	HOLDER, SPC
	CF1-1948-000 000	C	1	LENS LOCK PIN ASS'Y
*	CG2-1845-000 000	B	1	SHUTTER ASS'Y
*	CG2-1859-000 000	C	1	CONTACT ASS'Y, MOUNT
*	CG2-1860-000 000	C	1	FPC ASS'Y, ILC
*	CG2-1863-000 000	C	1	MIRROR ASS'Y
*	CG2-1874-000 000	C	1	FINDER UNIT
*	CG2-1876-000 000	C	1	FPC ASS'Y, EXPOSURE PROCESSING
*	CG2-1878-000 000	C	1	FPC ASS'Y, SI
*	CH1-8434-000 000	C	1	FPC, SHUTTER
	CS2-5020-000 000	E	1	SPRING, COIL
	CS2-7205-000 000	D	1	SPRING, MOUNT
	CS5-0250-000 000	C	1	SPRING, SUB MIRROR
*	CY3-1568-000 000	B	1	MIRROR BOX ASS'Y
	XA4-5170-307 000	F	1	SCREW
	XA4-9170-307 000	F	2	SCREW, CROSS-RECESS, PH
	XA4-9170-309 000	F	1	SCREW, CROSS-RECESS, PH
	XA4-9170-407 000	F	2	SCREW, CROSS-RECESS, PH
	XA4-9170-457 000	F	3	SCREW, CROSS-RECESS, PH
	XA4-9170-459 000	F	2	SCREW, CROSS-RECESS, PH

CANON DIGITAL CAMERA EOS KISS DIGITAL X
EOS DIGITAL REBEL XTII
EOS 400D DIGITAL

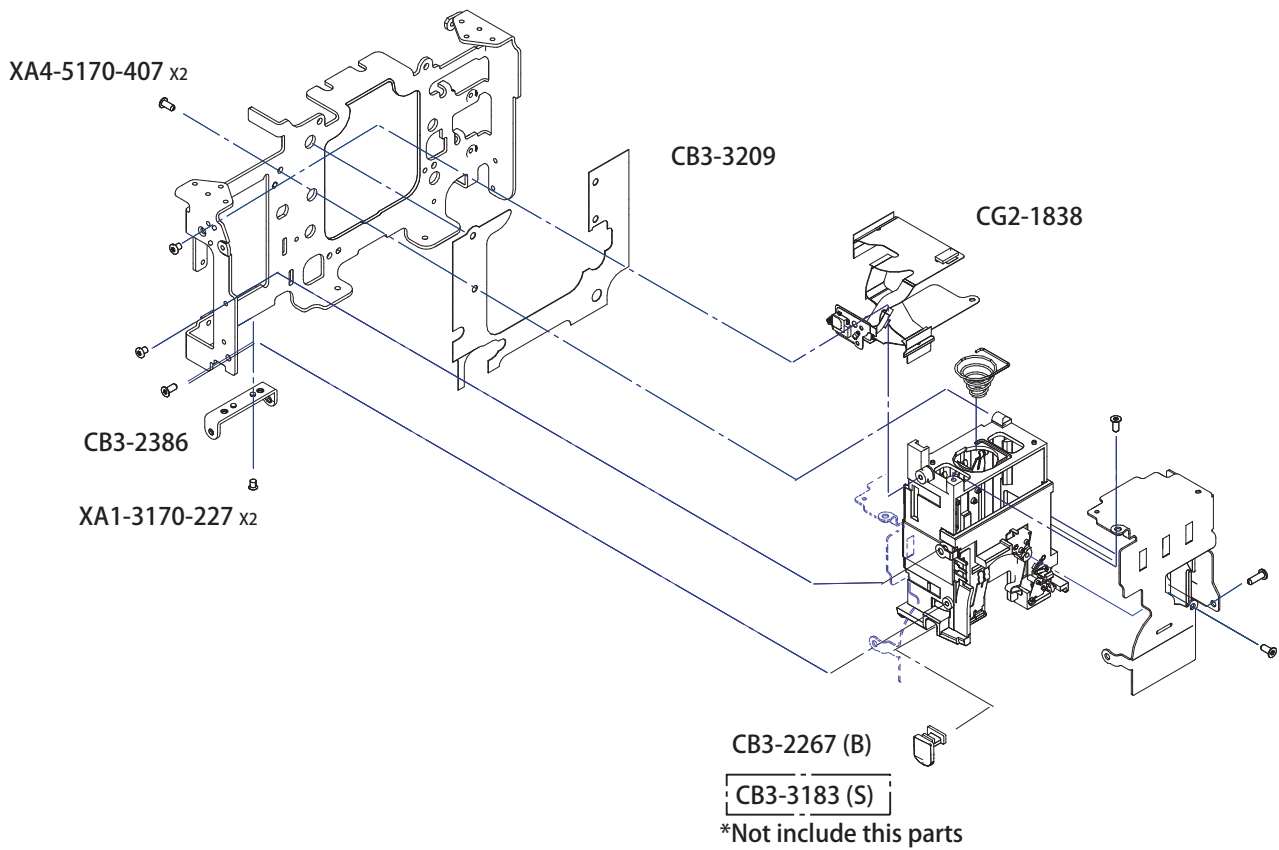

Those parts illustrated without parts numbers are **N.S** parts.
部品番号が記載されていないイラストは全て **N.S** 部品です。

PARTS LIST

REF. NO. C12-6151, 2
C12-6153, 4
C12-6155, 6

NEW	PARTS NO.	CLASS	QTY	DESCRIPTION
*	CB3-2267-000 000	C	1	COVER, CABLE(BLACK)
*	CB3-2386-000 000	C	1	HINGE, BATTERY COVER
*	CB3-3183-000 000	C	1	COVER, CABLE(SILVER)
*	CB3-3209-000 000	C	1	TAPE, DOUBLE SIDE BODY
*	CG2-1838-000 000	C	1	FPC ASS'Y, DOOR SWITCH
*	XA1-3170-227 000	F	2	SCREW, M1.7X2.2
	XA4-5170-407 000	F	2	SCREW

CANON DIGITAL CAMERA EOS KISS DIGITAL X
EOS DIGITAL REBEL XTi
EOS 400D DIGITAL

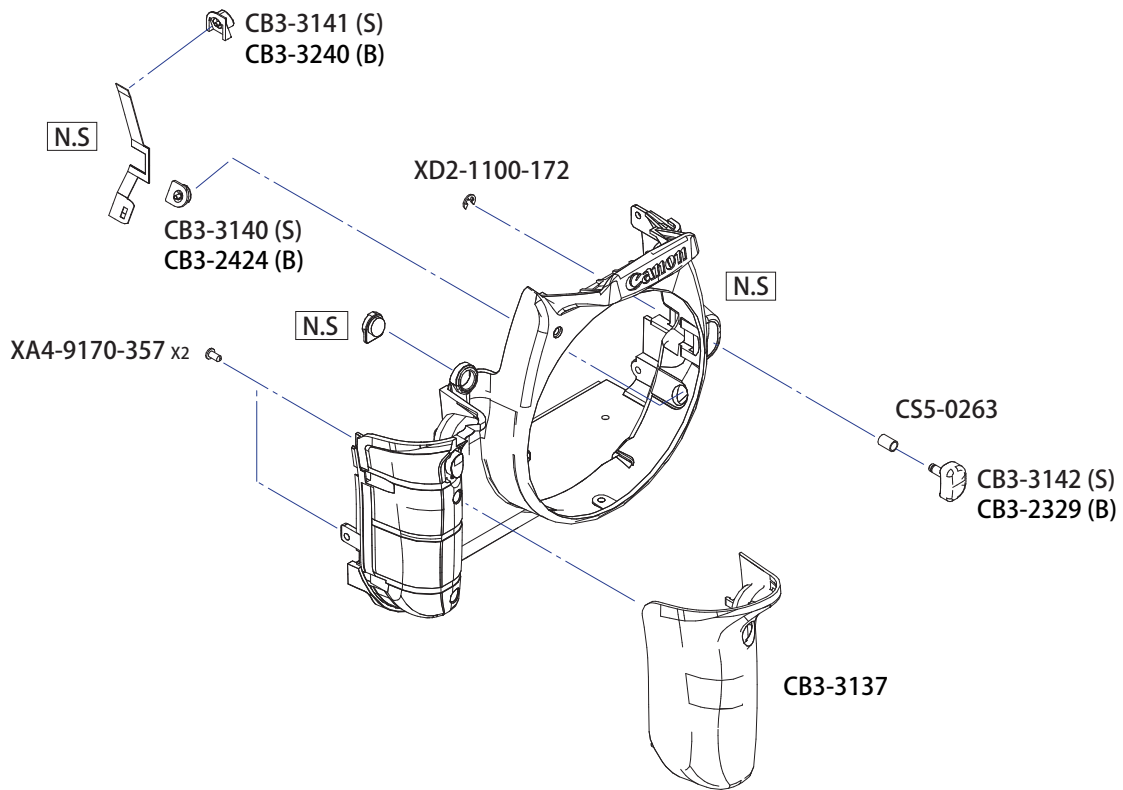

P A R T S L I S T

REF. NO. C12-6151, 2
 C12-6153, 4
 C12-6155, 6

NEW	PARTS NO.	CLASS	QTY	DESCRIPTION
	CB3-2329-000 000	C	1	BUTTON, UNLOCK
	CB3-2424-000 000	C	1	BUTTON, PREVIEW
*	CB3-3137-000 000	C	1	COVER, GRIP
*	CB3-3140-000 000	C	1	BUTTON, PREVIEW
*	CB3-3141-000 000	C	1	BUTTON, FLASH POP-UP(SILVER)
*	CB3-3142-000 000	C	1	BUTTON, UNLOCK(SILVER)
*	CB3-3240-000 000	C	1	BUTTON, FLASH POP-UP(BLACK)
	CS5-0263-000 000	C	1	SPRING, UNLOCK BUTTON
	XA4-9170-357 000	F	2	SCREW, CROSS-RECESS, PH
	XD2-1100-172 000	F	1	RETAINING RING (E-TYPE), M1.7

P A R T S L I S T

REF. NO. C12-6151, 2
 C12-6153, 4
 C12-6155, 6

NEW	PARTS NO.	CLASS	QTY	DESCRIPTION
	CA1-9328-000 000	C	1	SPRING, PLATE (BL)
*	CB3-1418-001 000	C	1	SHOE, ACCESSORY
*	CB3-2409-000 000	C	4	SCREW, M2.5X3.8
	CB3-2410-000 000	C	1	SHOE, ACCESSORY, S
*	CB3-2411-000 000	C	1	BASE, ACCESSORY SHOE
*	CB3-3213-000 000	N	1	COVER, FLASH(SILVER)
*	CB3-3253-000 000	N	1	COVER, FLASH(BLACK)
*	CG2-1854-000 000	C	1	DIAL ASS'Y
	WC2-5462-000 000	C	1	SWITCH, PUSH BUTTON (RELEASE)
	XA4-9170-407 000	F	2	SCREW, CROSS-RECESS, PH

CANON DIGITAL CAMERA EOS KISS DIGITAL X
EOS DIGITAL REBEL XTi
EOS 400D DIGITAL

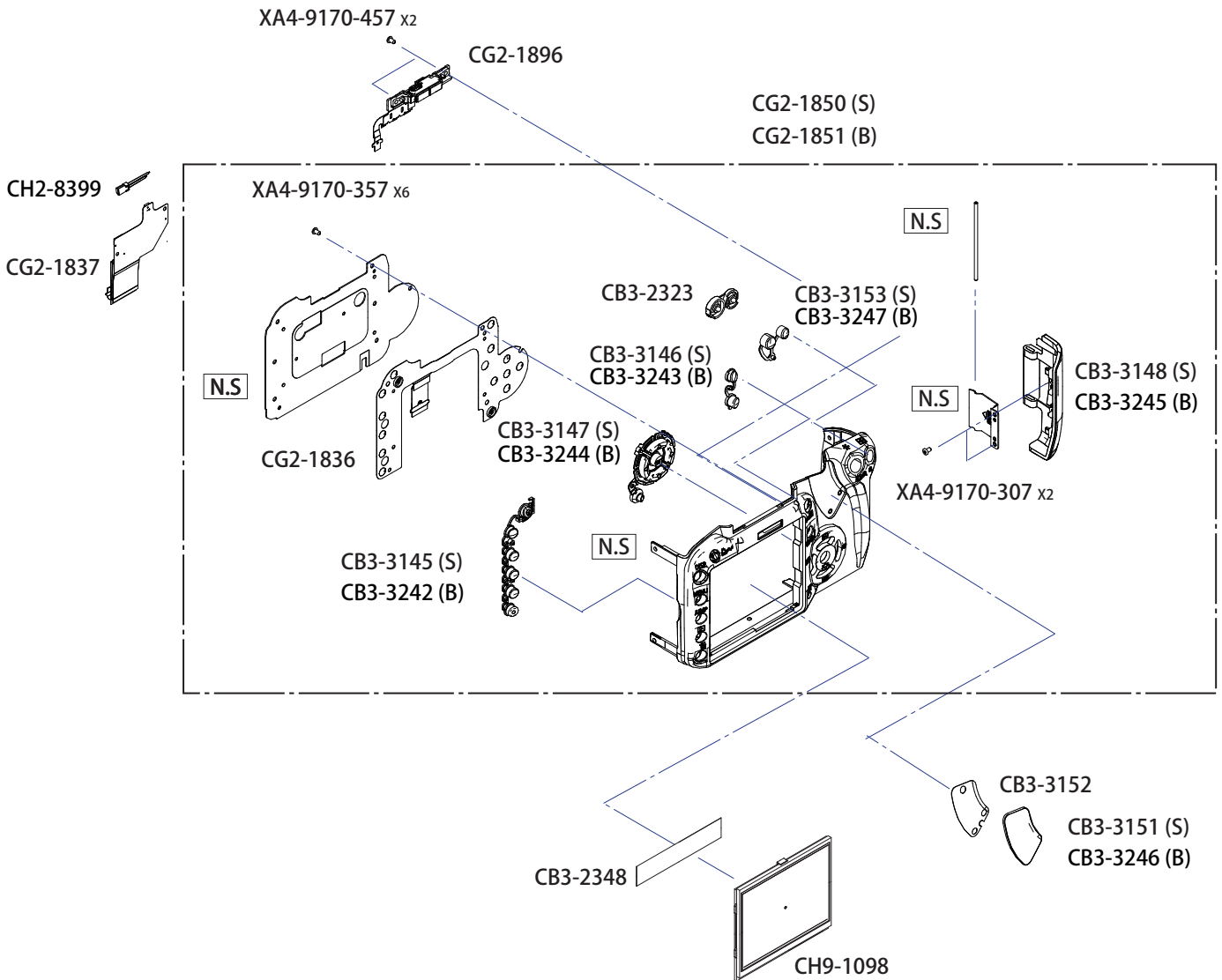

P A R T S L I S T

REF. NO. C12-6151, 2
 C12-6153, 4
 C12-6155, 6

NEW	PARTS NO.	CLASS	QTY	DESCRIPTION
	CB3-2323-000 000	C	1	COVER, AE/FP SELECT BUTTON
	CB3-2348-000 000	C	1	TAPE, TFT GROUNDING
*	CB3-3145-000 000	C	1	BUTTON, MODE(SILVER)
*	CB3-3146-000 000	C	1	BUTTON, AV(SILVER)
*	CB3-3147-000 000	C	1	BUTTON, SET SELECT(SILVER)
*	CB3-3148-000 000	C	1	COVER ASS'Y, CF SLOT(SILVER)
*	CB3-3151-000 000	B	1	COVER, BACK HOLDING(SILVER)
*	CB3-3152-000 000	B	1	TAPE, DOUBLE SIDE HOLDING
*	CB3-3153-000 000	C	1	BUTTON, AE-L(SILVER)
*	CB3-3242-000 000	C	1	BUTTON, MODE(BLACK)
*	CB3-3243-000 000	C	1	BUTTON, AV(BLACK)
*	CB3-3244-000 000	C	1	BUTTON, SET SELECT(BLACK)
*	CB3-3245-000 000	C	1	COVER ASS'Y, CF SLOT(BLACK)
*	CB3-3246-000 000	B	1	COVER, BACK HOLDING(BLACK)
*	CB3-3247-000 000	C	1	BUTTON, AE-L(BLACK)
*	CG2-1836-000 000	C	1	FPC ASS'Y, BACK SWITCH
*	CG2-1837-000 000	C	1	FPC ASS'Y, BACK
*	CG2-1850-000 000	B	1	COVER ASS'Y, BACK(SILVER)
*	CG2-1851-000 000	B	1	COVER ASS'Y, BACK(BLACK)
*	CG2-1896-000 000	C	1	PCB ASS'Y, FACE DETECT
*	CH2-8399-000 000	C	1	LEAD ASS'Y, TFT
*	CH9-1098-000 000	C	1	LCD ASS'Y, TFT
	XA4-9170-307 000	F	2	SCREW, CROSS-RECESS, PH
	XA4-9170-357 000	F	6	SCREW, CROSS-RECESS, PH
	XA4-9170-457 000	F	2	SCREW, CROSS-RECESS, PH

Accessories

Battery Charger CB-2LW/2LWE

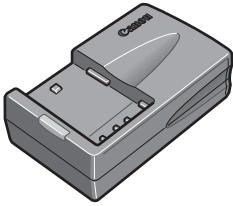

N.S (Product Available)

Battery Pack NB-2LH

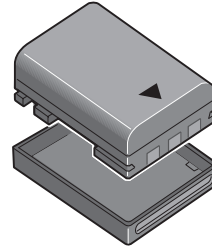

N.S (Product Available)

DC Coupler DR-700

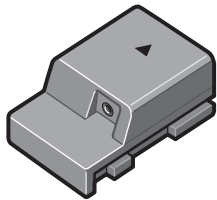

C84-1078

Compact Power Adapter CA-PS700

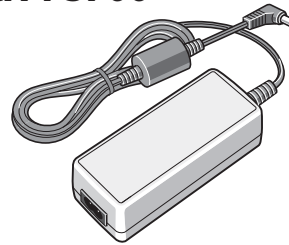

N.S (Product Available)

Interface Cable IFC-400 PCU(USB)

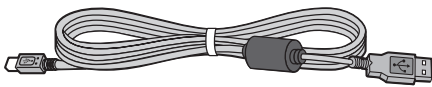

N.S (Product Available)

Video Cable VC-100

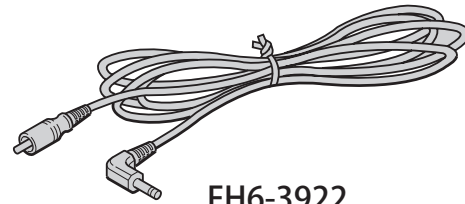

FH6-3922

Wide Strap EW-100DB II

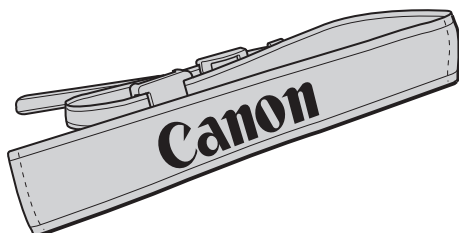

PARTS LIST

BATTERY CHARGER CB-5L

REF. NO. C84-1078-000

NEW	PARTS NO.	CLASS	QTY	DESCRIPTION
*	C84-1078-000	B	1	DC COUPLER DR-700

VIDEO CABLE VC-100

REF. NO. FH6-3922

NEW	PARTS NO.	CLASS	QTY	DESCRIPTION
	FH6-3922-000	C	1	VIDEO CABLE VC-100

INDEX OF PARTS LIST

REF. NO. C12-6151, 2
 C12-6153, 4
 C12-6155, 6

NEW	PARTS NO.	PAGE	NEW	PARTS NO.	PAGE
	CA1-9328-000 000	8	*	CB3-3139-000 000	2
	CB1-4085-000 000	5	*	CB3-3140-000 000	7
	CB2-0682-000 (XXX)	3	*	CB3-3141-000 000	7
	CB3-1086-000 000	2	*	CB3-3142-000 000	7
*	CB3-1418-001 000	8	*	CB3-3145-000 000	9
	CB3-1700-000 000	5	*	CB3-3146-000 000	9
	CB3-1706-000 000	4	*	CB3-3147-000 000	9
	CB3-1815-000 000	1	*	CB3-3148-000 000	9
	CB3-2112-000 000	1	*	CB3-3149-000 000	1
	CB3-2112-000 000	2	*	CB3-3150-000 000	1
	CB3-2113-000 000	2	*	CB3-3151-000 000	9
	CB3-2114-000 000	2	*	CB3-3152-000 000	9
	CB3-2115-000 000	2	*	CB3-3153-000 000	9
	CB3-2214-000 000	5	*	CB3-3154-000 000	1
	CB3-2229-000 000	2	*	CB3-3155-000 000	1
	CB3-2232-000 (XXX)	2	*	CB3-3156-000 000	4
*	CB3-2267-000 000	6	*	CB3-3157-000 000	3
	CB3-2323-000 000	9	*	CB3-3160-000 000	1
	CB3-2329-000 000	7	*	CB3-3164-000 000	1
*	CB3-2339-000 000	1	*	CB3-3170-000 000	3
	CB3-2347-000 000	2	*	CB3-3183-000 000	6
	CB3-2348-000 000	9	*	CB3-3209-000 000	6
*	CB3-2386-000 000	6	*	CB3-3213-000 000	8
	CB3-2392-000 000	1	*	CB3-3216-000 000	1
	CB3-2403-000 000	5	*	CB3-3217-000 000	1
*	CB3-2409-000 000	8	*	CB3-3217-000 000	2
	CB3-2410-000 000	8	*	CB3-3218-000 000	2
*	CB3-2411-000 000	8	*	CB3-3219-000 000	1
	CB3-2424-000 000	7	*	CB3-3220-000 000	2
	CB3-2468-000 000	1	*	CB3-3221-000 000	2
	CB3-2808-000 000	3	*	CB3-3230-000 000	2
*	CB3-3127-000 000	5	*	CB3-3231-000 000	2
*	CB3-3135-000 000	2	*	CB3-3232-000 000	2
*	CB3-3137-000 000	7	*	CB3-3233-000 000	2
*	CB3-3138-000 000	2	*	CB3-3238-000 000	2

INDEX OF PARTS LIST

REF. NO. C12-6151, 2
 C12-6153, 4
 C12-6155, 6

NEW	PARTS NO.	PAGE	NEW	PARTS NO.	PAGE
*	CB3-3240-000 000	7	*	CG2-1872-000 000	1
*	CB3-3242-000 000	9	*	CG2-1874-000 000	5
*	CB3-3243-000 000	9	*	CG2-1876-000 000	5
*	CB3-3244-000 000	9	*	CG2-1878-000 000	5
*	CB3-3245-000 000	9	*	CG2-1880-000 000	1
*	CB3-3246-000 000	9	*	CG2-1896-000 000	9
*	CB3-3247-000 000	9	*	CH1-8434-000 000	5
*	CB3-3248-000 000	1	*	CH1-8436-000 000	4
*	CB3-3249-000 000	1	*	CH1-8440-000 000	4
*	CB3-3250-000 000	4	*	CH2-8399-000 000	9
*	CB3-3253-000 000	8	*	CH2-8400-000 000	4
*	CB3-3717-000 000	3	*	CH2-8401-000 000	4
	CF1-1948-000 000	5	*	CH2-8431-000 000	4
*	CG2-1835-000 000	4	*	CH2-8432-000 000	3
*	CG2-1836-000 000	9	*	CH9-1098-000 000	9
*	CG2-1837-000 000	9		CS2-5020-000 000	5
*	CG2-1838-000 000	6		CS2-7205-000 000	5
*	CG2-1840-000 000	3		CS5-0250-000 000	5
*	CG2-1843-000 000	4		CS5-0263-000 000	7
*	CG2-1845-000 000	5	*	CY3-1565-000 000	2
*	CG2-1848-000 000	2	*	CY3-1566-000 000	2
*	CG2-1849-000 000	2	*	CY3-1567-000 000	3
*	CG2-1850-000 000	9	*	CY3-1568-000 000	5
*	CG2-1851-000 000	9		VD7-2241-501 000	3
*	CG2-1852-000 000	2		VD7-2243-001 000	4
*	CG2-1853-000 000	2		WC2-5462-000 000	8
*	CG2-1854-000 000	8		WS1-6384-000 000	3
*	CG2-1859-000 000	5	*	XA1-3170-227 000	4
*	CG2-1860-000 000	5	*	XA1-3170-227 000	6
*	CG2-1862-000 000	4		XA1-3200-257 000	3
*	CG2-1863-000 000	5		XA1-7170-167 000	3
*	CG2-1866-000 000	4		XA1-7170-257 000	3
*	CG2-1868-000 000	4		XA1-7170-307 000	3
*	CG2-1869-000 000	3		XA4-5170-307 000	5
*	CG2-1871-000 000	3		XA4-5170-407 000	6

INDEX OF PARTS LIST

REF. NO. C12-6151, 2
 C12-6153, 4
 C12-6155, 6

NEW	PARTS NO.	PAGE	NEW	PARTS NO.	PAGE
	XA4-9170-257 000	4			
	XA4-9170-307 000	4			
	XA4-9170-307 000	5			
	XA4-9170-307 000	9			
	XA4-9170-309 000	5			
	XA4-9170-357 000	7			
	XA4-9170-357 000	9			
	XA4-9170-407 000	4			
	XA4-9170-407 000	5			
	XA4-9170-407 000	8			
	XA4-9170-457 000	4			
	XA4-9170-457 000	5			
	XA4-9170-457 000	9			
	XA4-9170-459 000	5			
	XA4-9170-507 000	3			
	XA4-9200-507 000	3			
	XD2-1100-172 000	7			
*	YN2-3580-000 000	2			

Circuit Diagrams

Trademarks

The product names and company names described in this Service Manual are the registered trademarks of the individual companies.

Copyright

Canon Inc. retains the copyright to this Service Manual. Reproduction, publication (including on the World Wide Web), alteration, translation into another language, or other use of the data in whole or part, contained on this Service Manual without the written consent of Canon Inc. is prohibited.

CONTENTS

Circuit Diagrams

1. WIRING DIAGRAM
 - LEADWIRE LAYOUT
2. BLOCK DIAGRAM
 - 2-1 GENERAL
 - 2-2 POWER SUPPLY
3. PCB DIAGRAM
 - 3-1 ASD PCB
 - 3-2 IF PCB
 - 3-3 MAIN PCB
 - 3-4 MD PCB
 - 3-5 ST PCB
 - 3-6 AE FPC
 - 3-7 AF FPC
 - 3-8 ASM FPC
 - 3-9 BM FPC
 - 3-10 DRSW FPC
 - 3-11 FDS FPC
 - 3-12 IMGB FPC
 - 3-13 IMGT FPC
 - 3-14 SH FPC
 - 3-15 SI FPC
 - 3-16 TSW FPC

1. WIRING DIAGRAM
LEADWIRE LAYOUT

REF. NO. C12-6151, 2
C12-6153, 4
C12-6155, 6

PARTS No.	REMARK
① CH2-8432	MAIN-I/F
② CH2-8431	MD-MAIN
③ CH2-8400	MD-FLASH
④ CH2-8401	ASD
⑤ CH2-8399	TFT

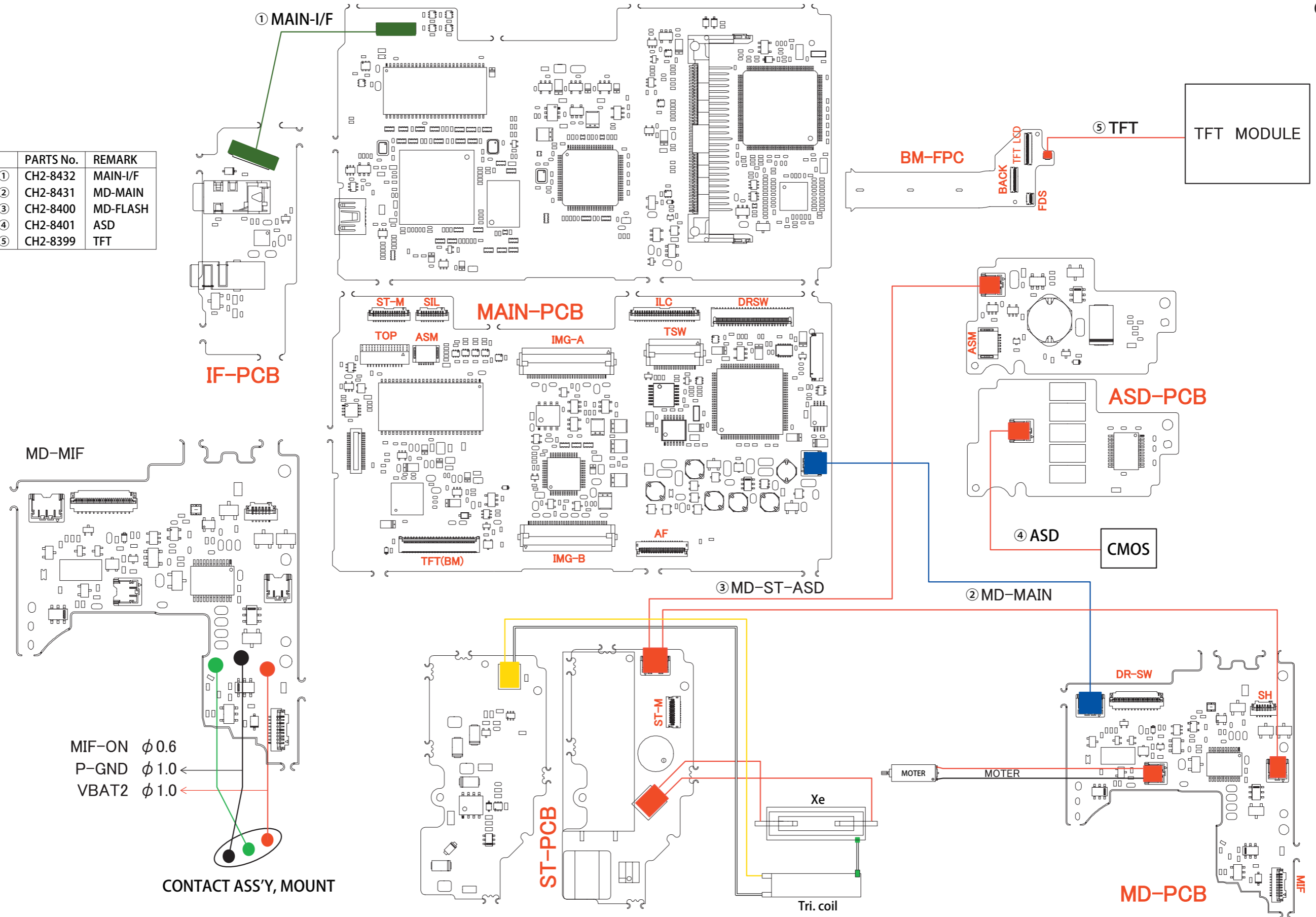

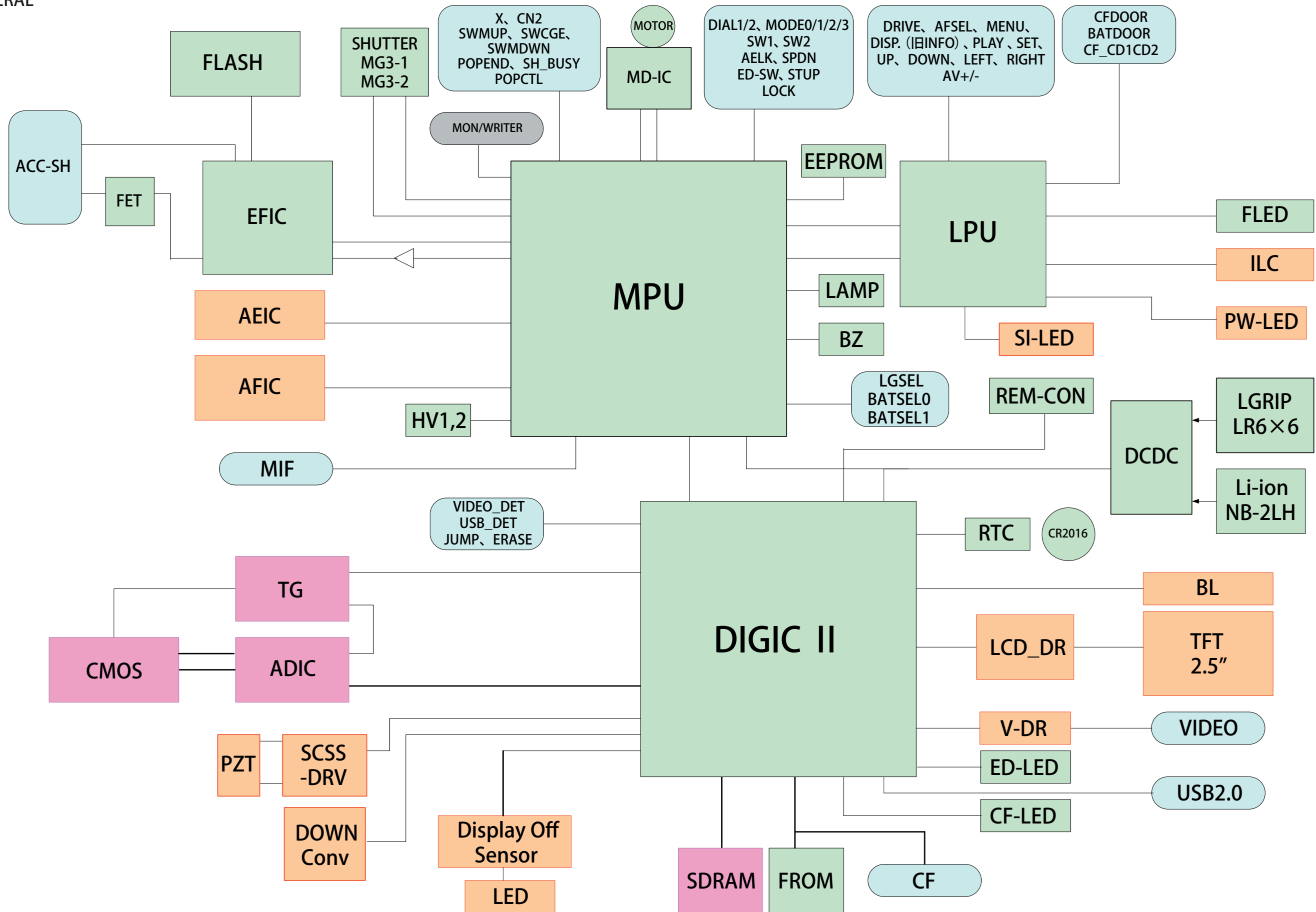

2. BLOCK DIAGRAM
2-2 POWER SUPPLY

REF. NO. C12-6151, 2
C12-6153, 4
C12-6155, 6

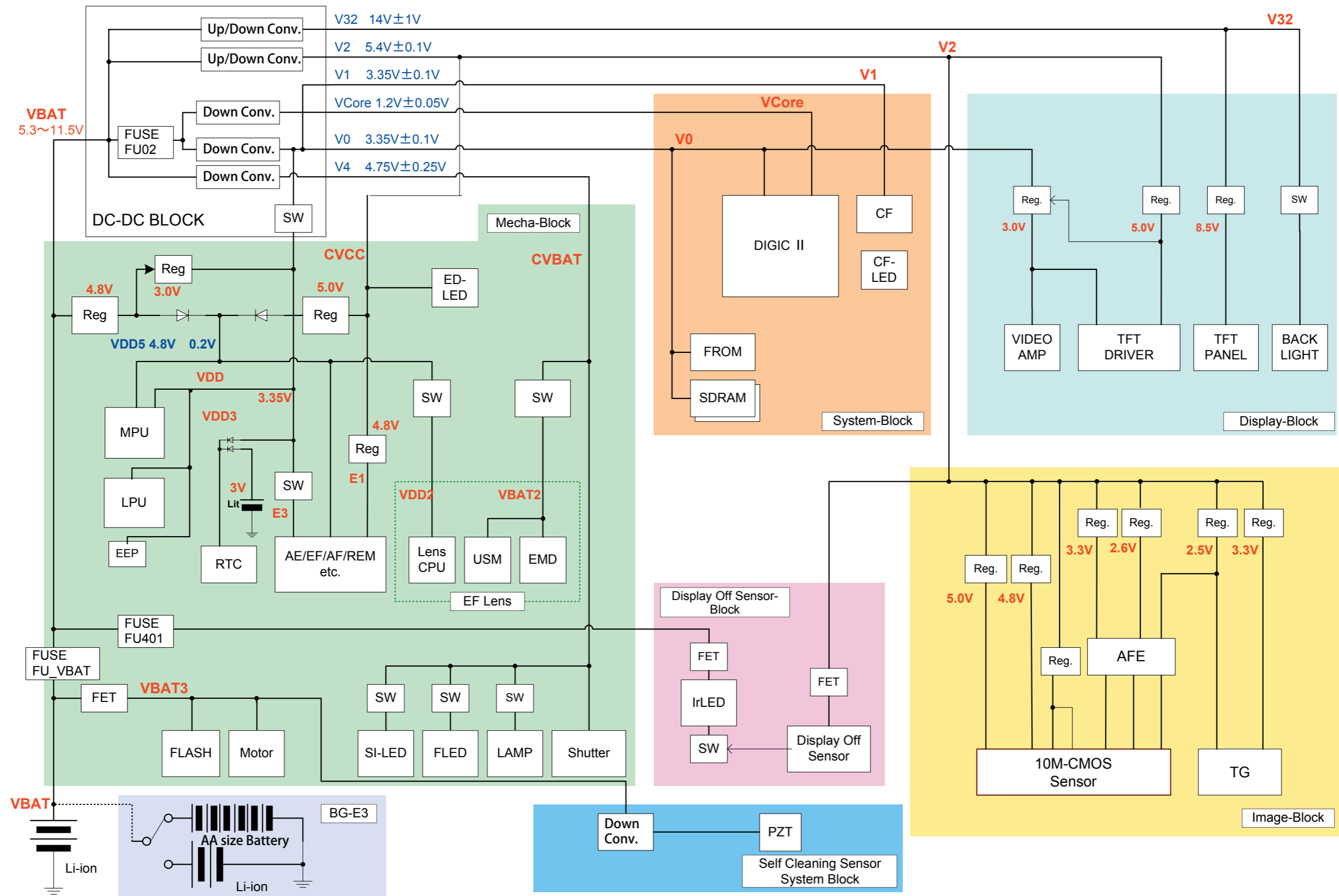

SIDE A

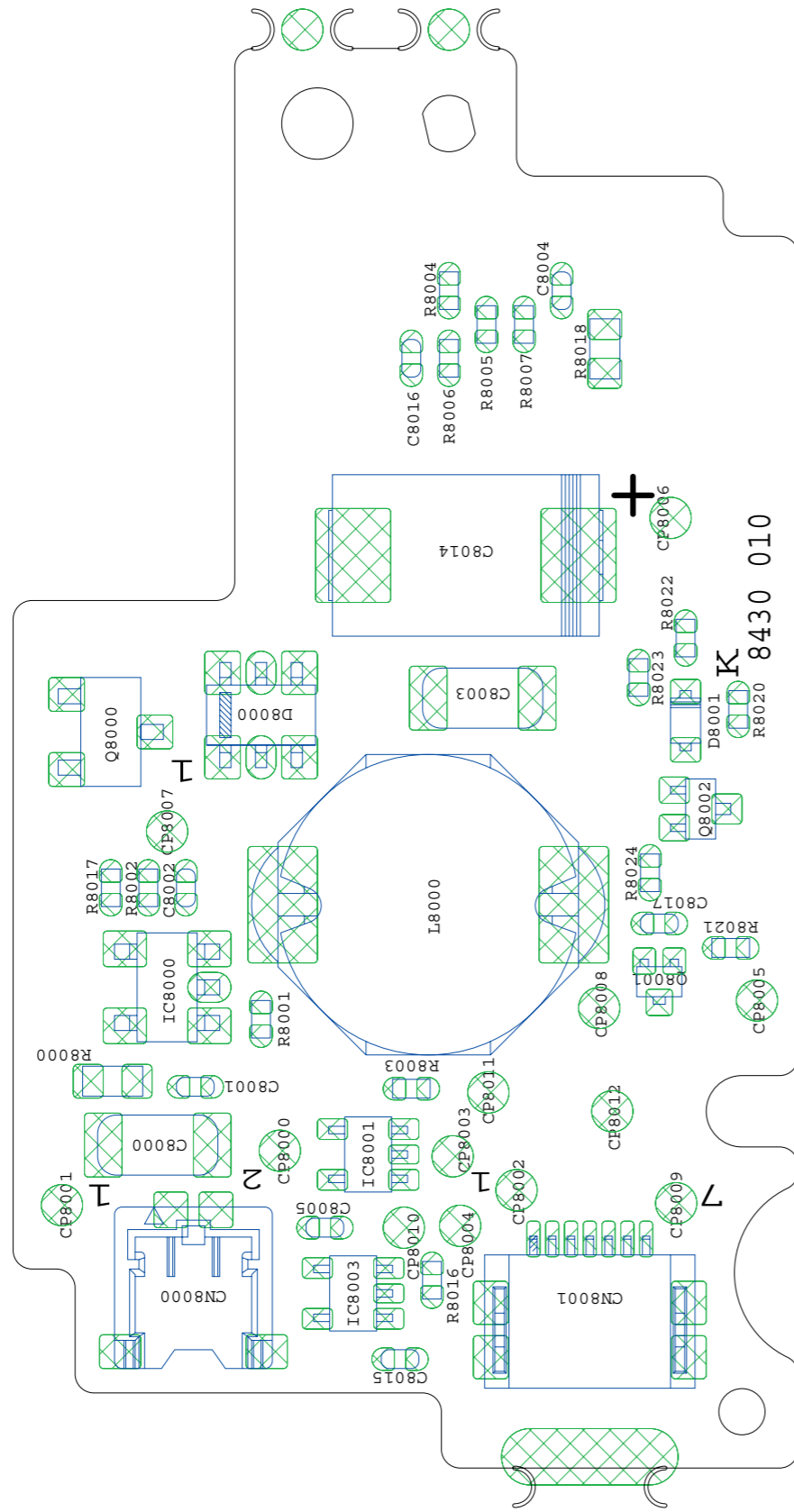

SIDE B

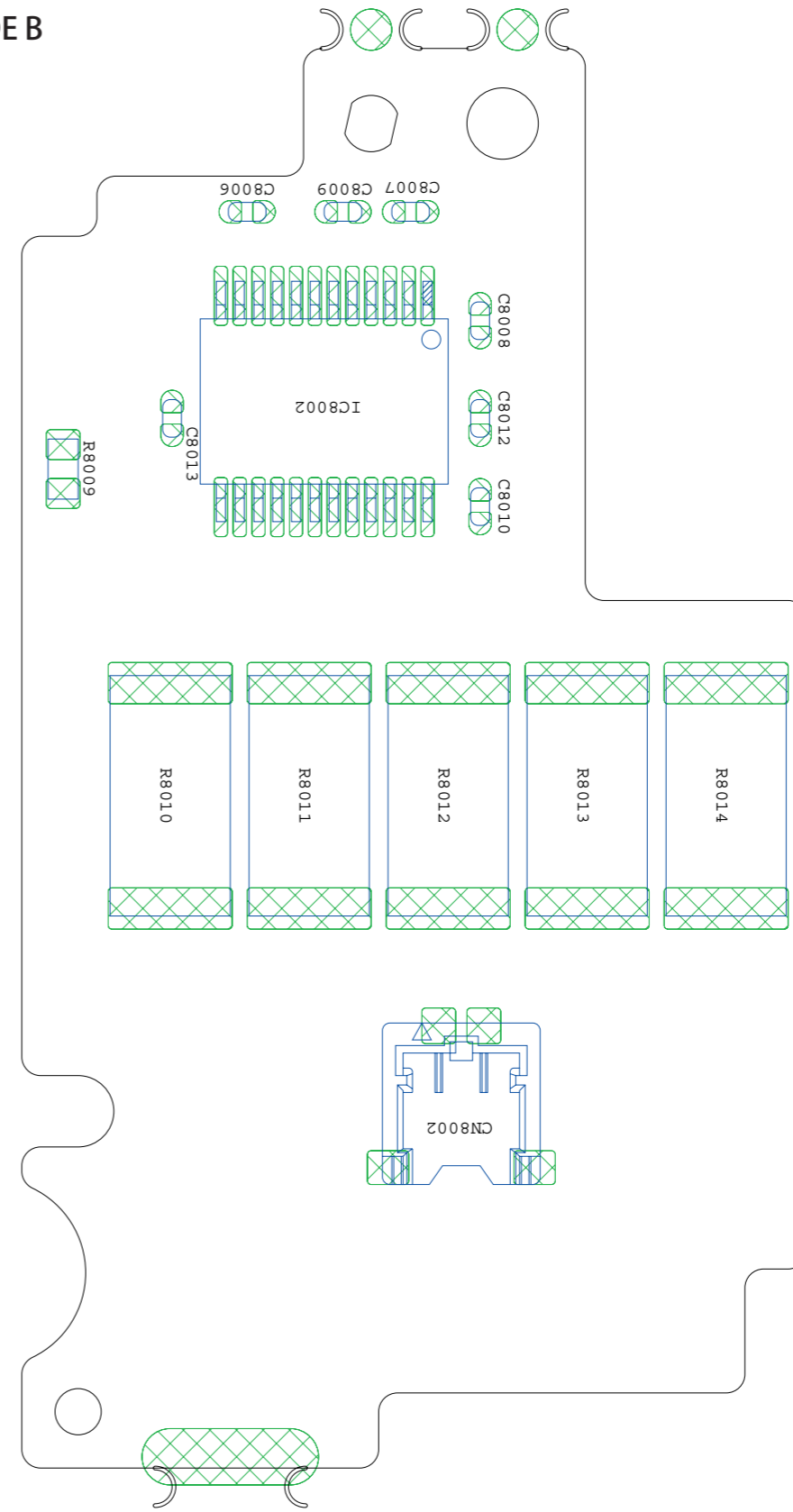

SIDE A

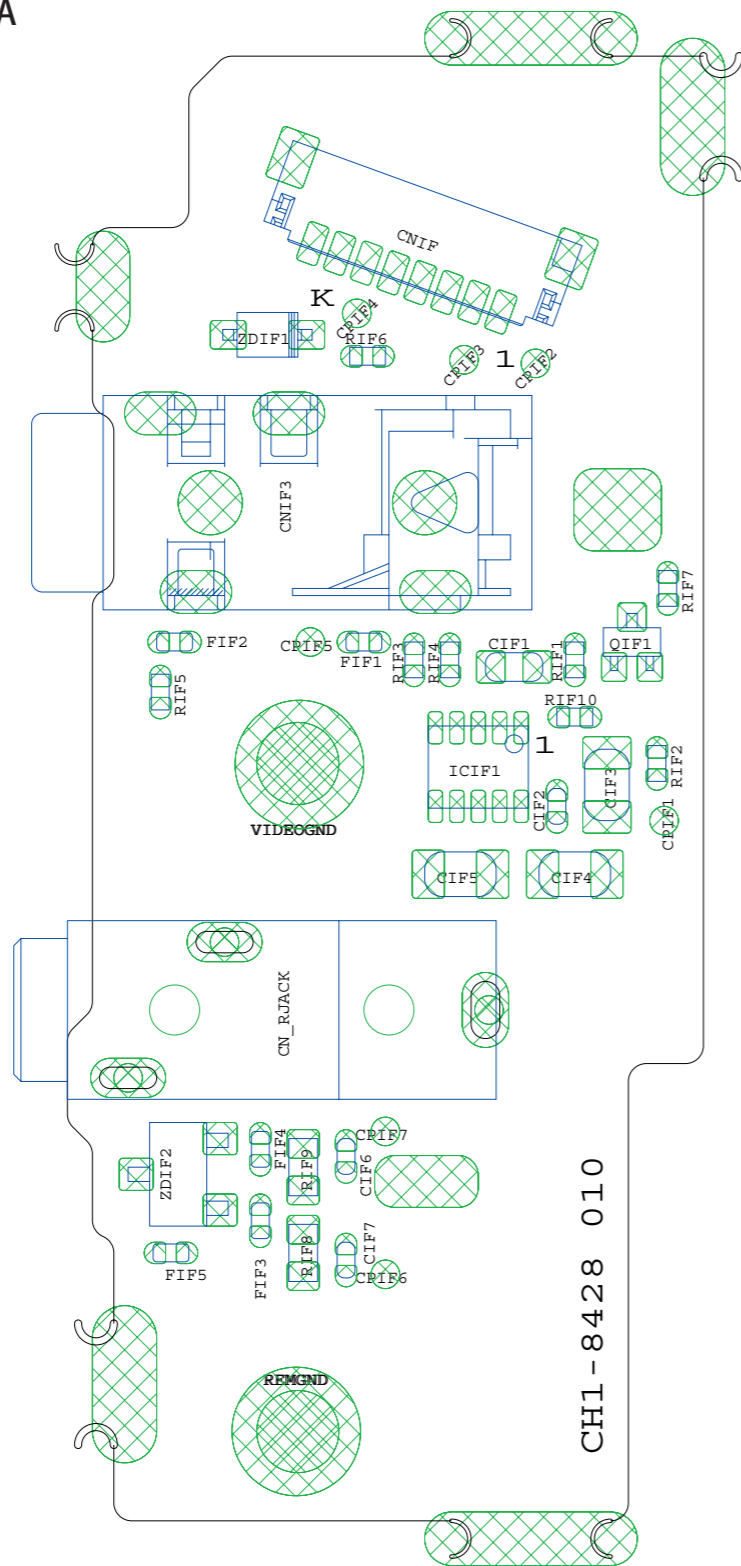

SIDE B

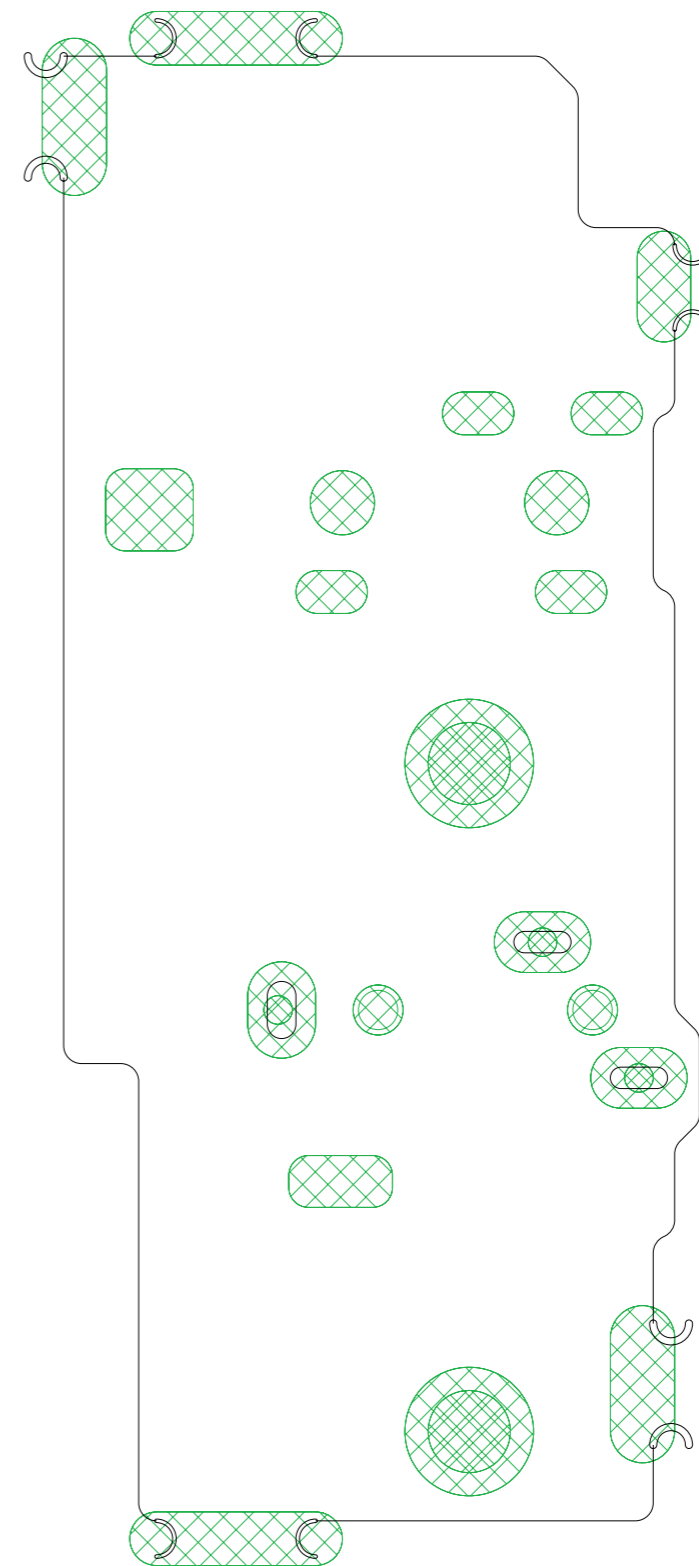

SIDE A

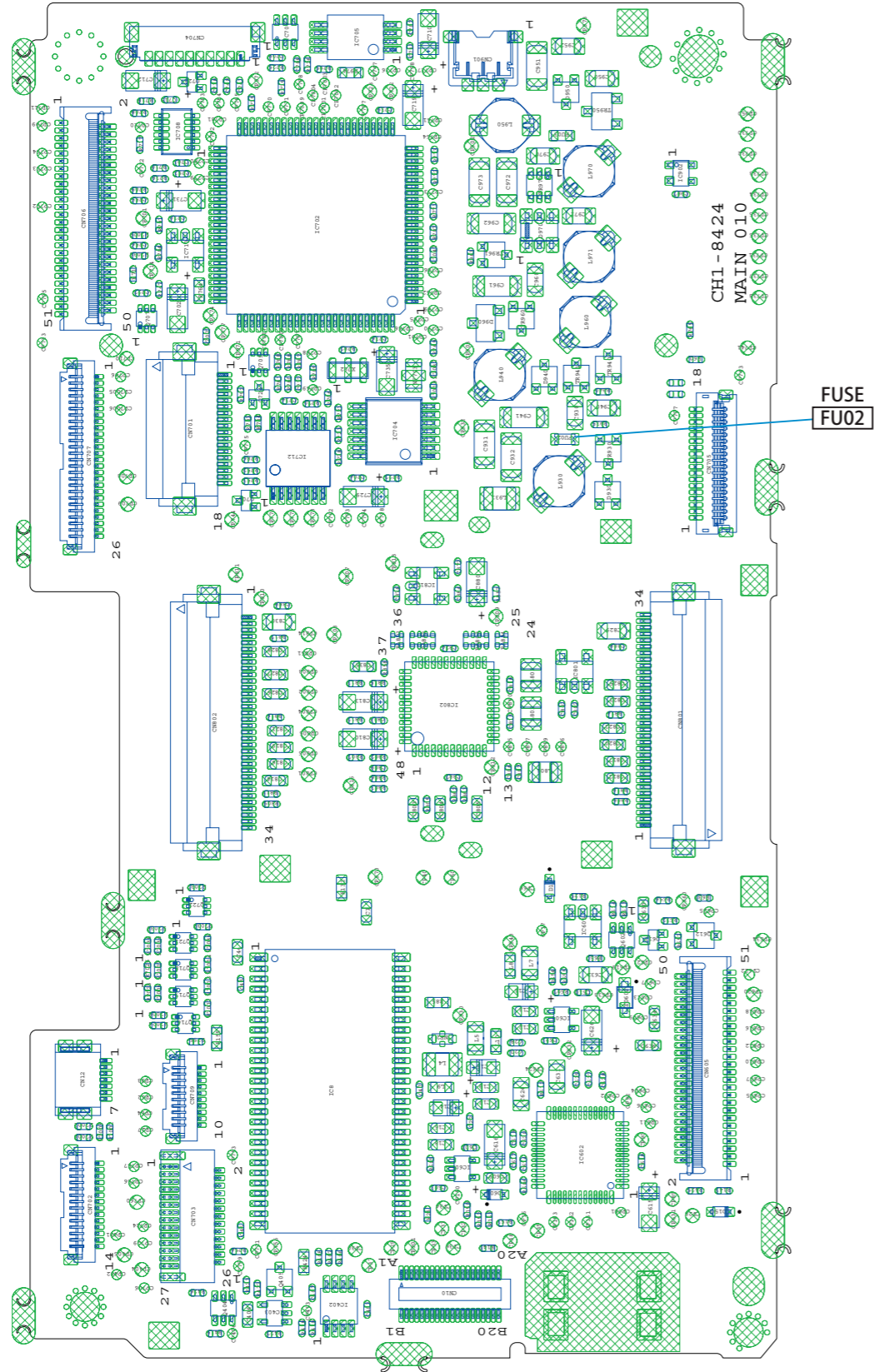

SIDE B

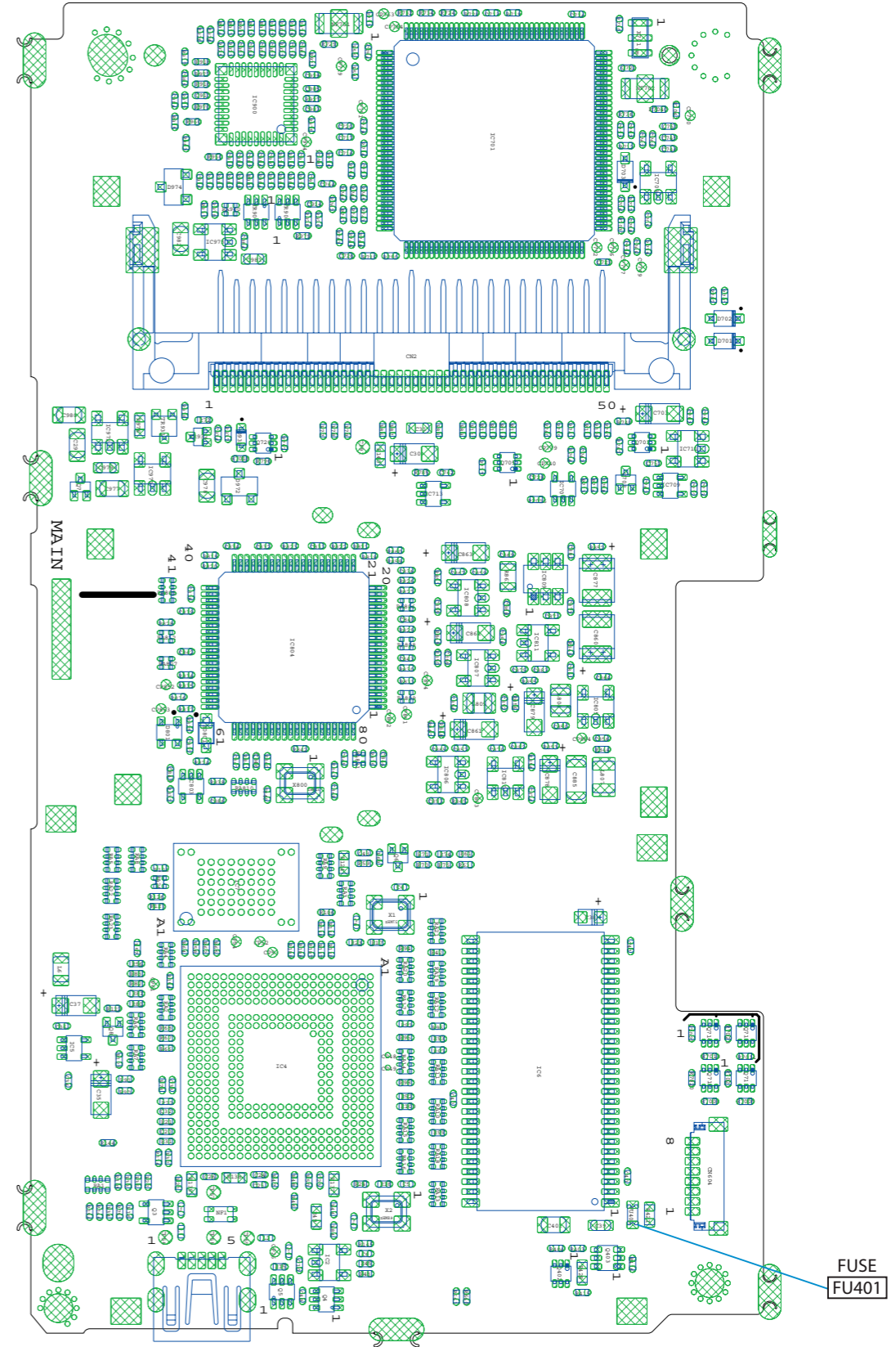

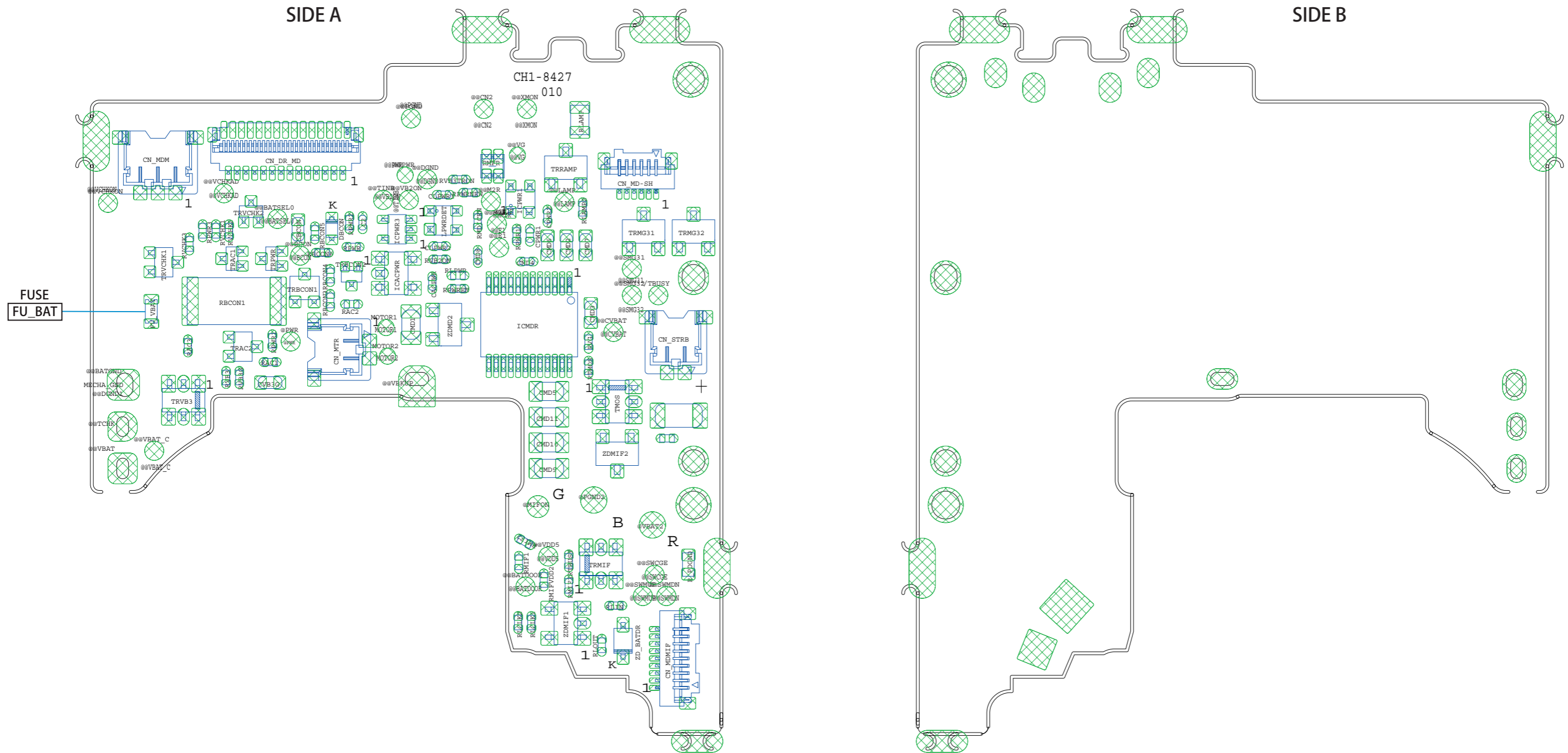

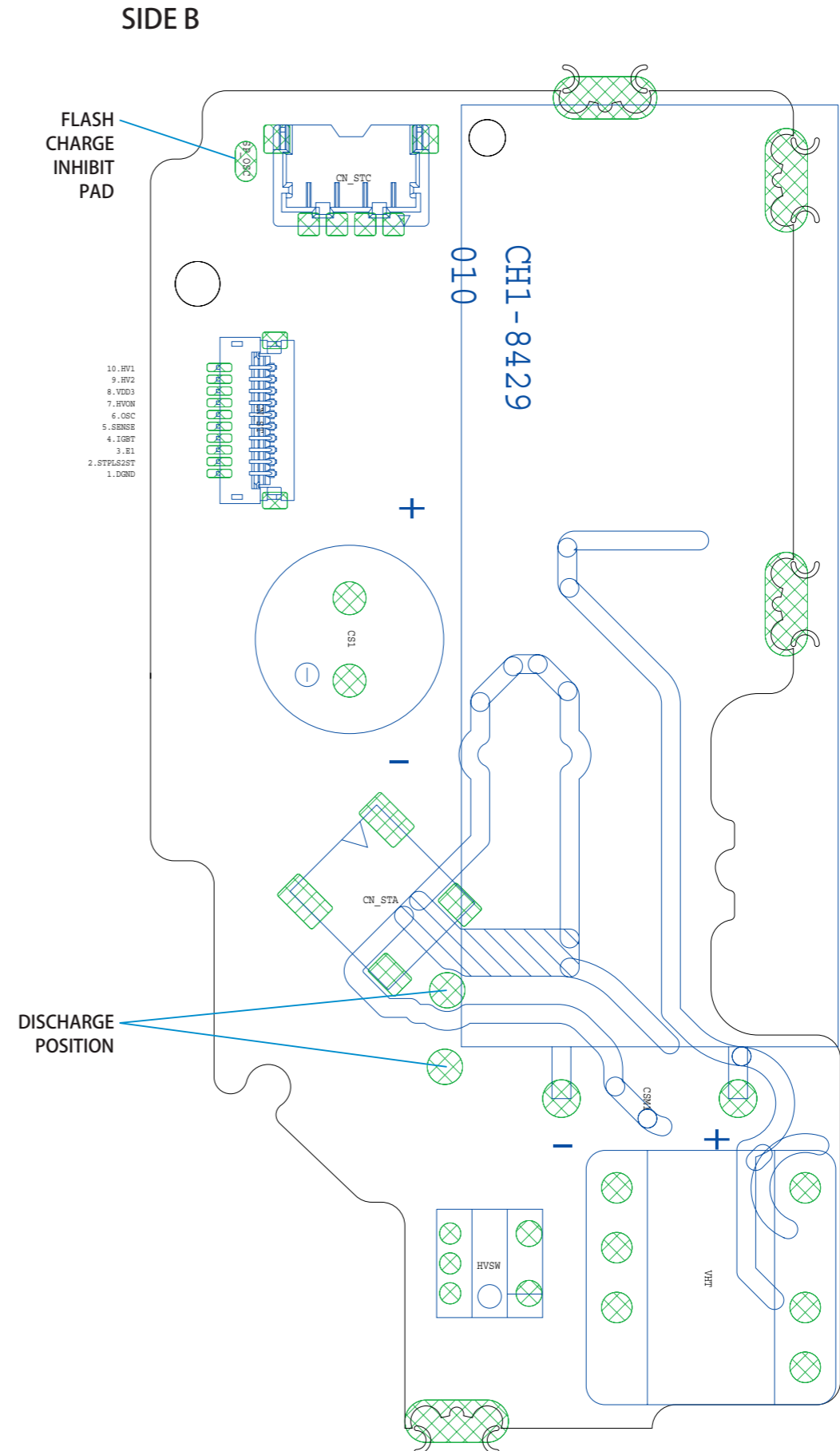
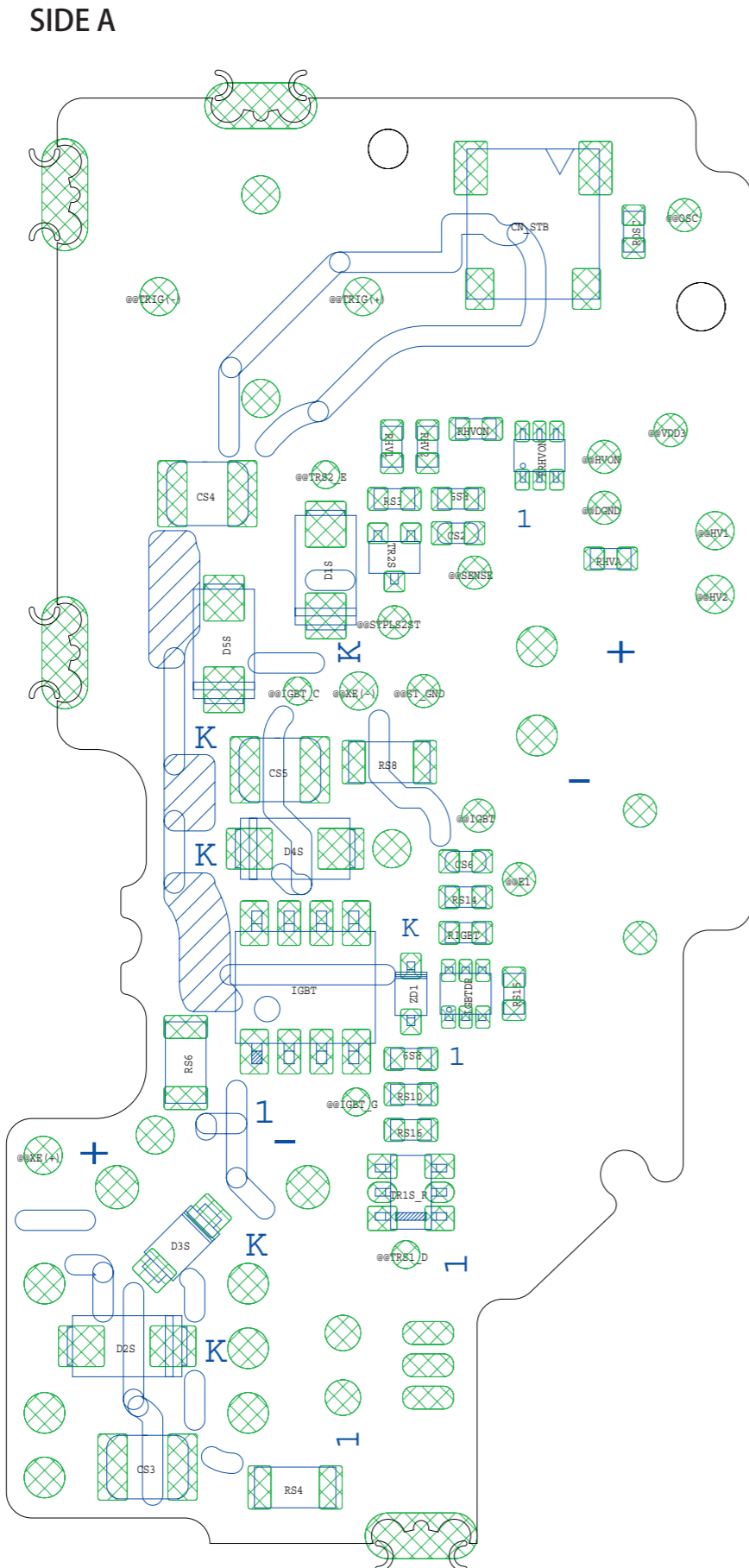

SIDE A

SIDE B

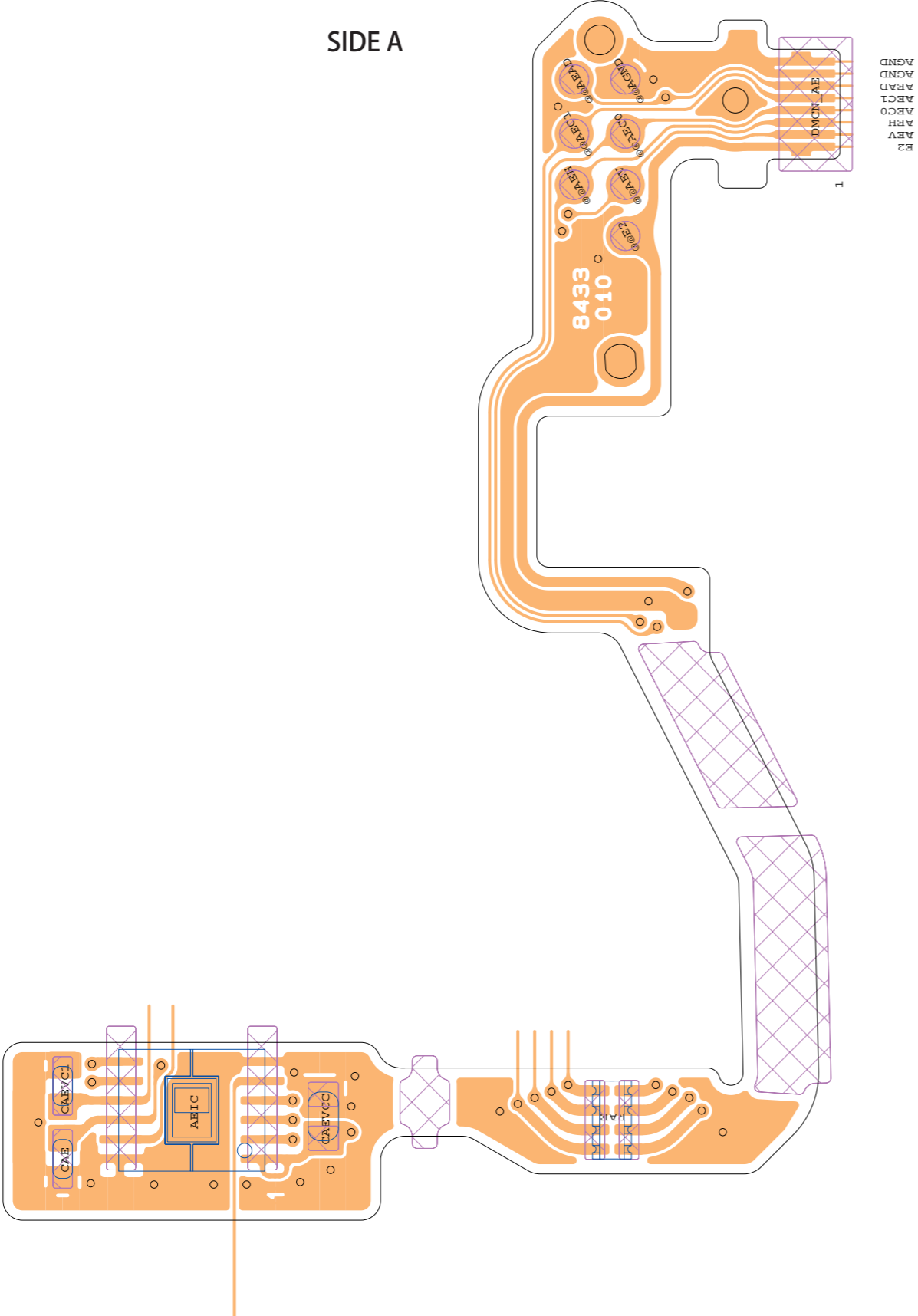

E2
 AEV
 AEH
 AEC0
 AEC1
 AED1
 AED0
 AGND
 AGND

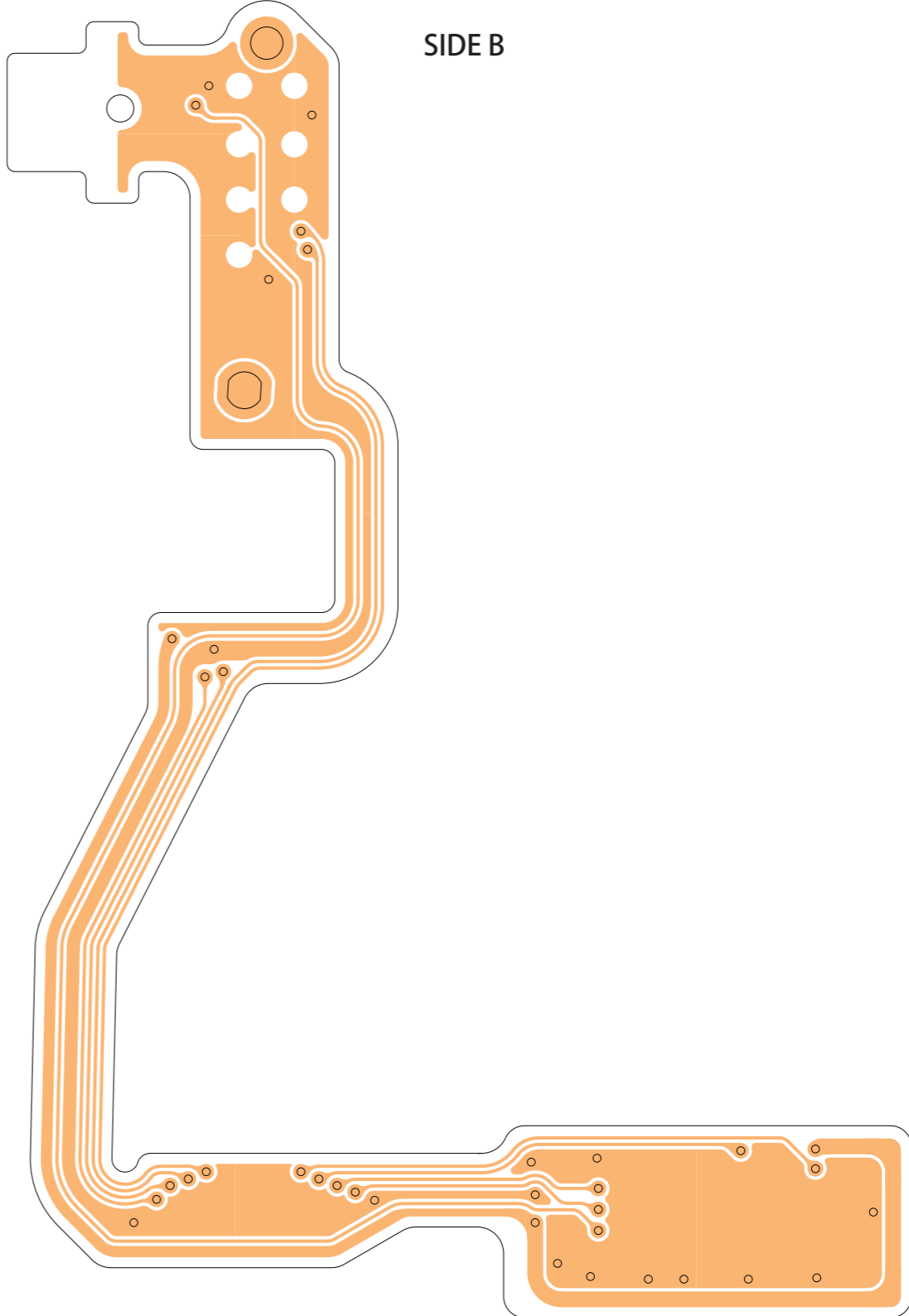

SIDE A

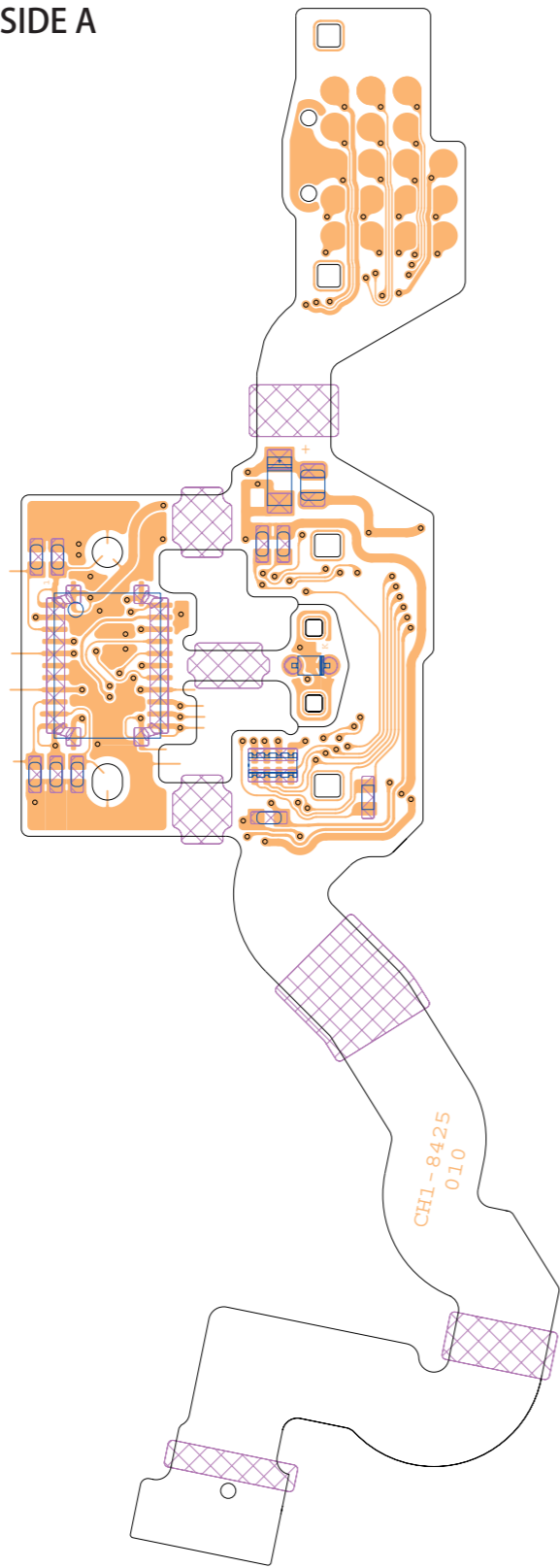

SIDE B

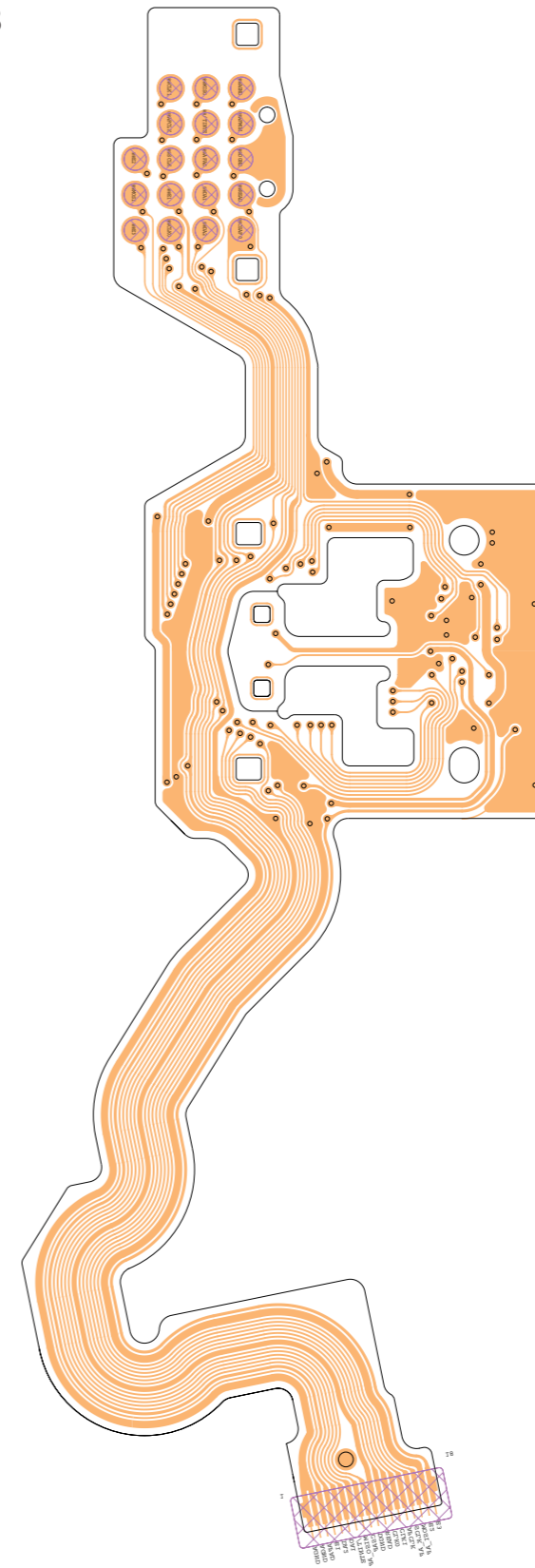

3. PCB DIAGRAM
3-8 ASM FPC

REF. NO. C12-6151, 2
C12-6153, 4
C12-6155, 6

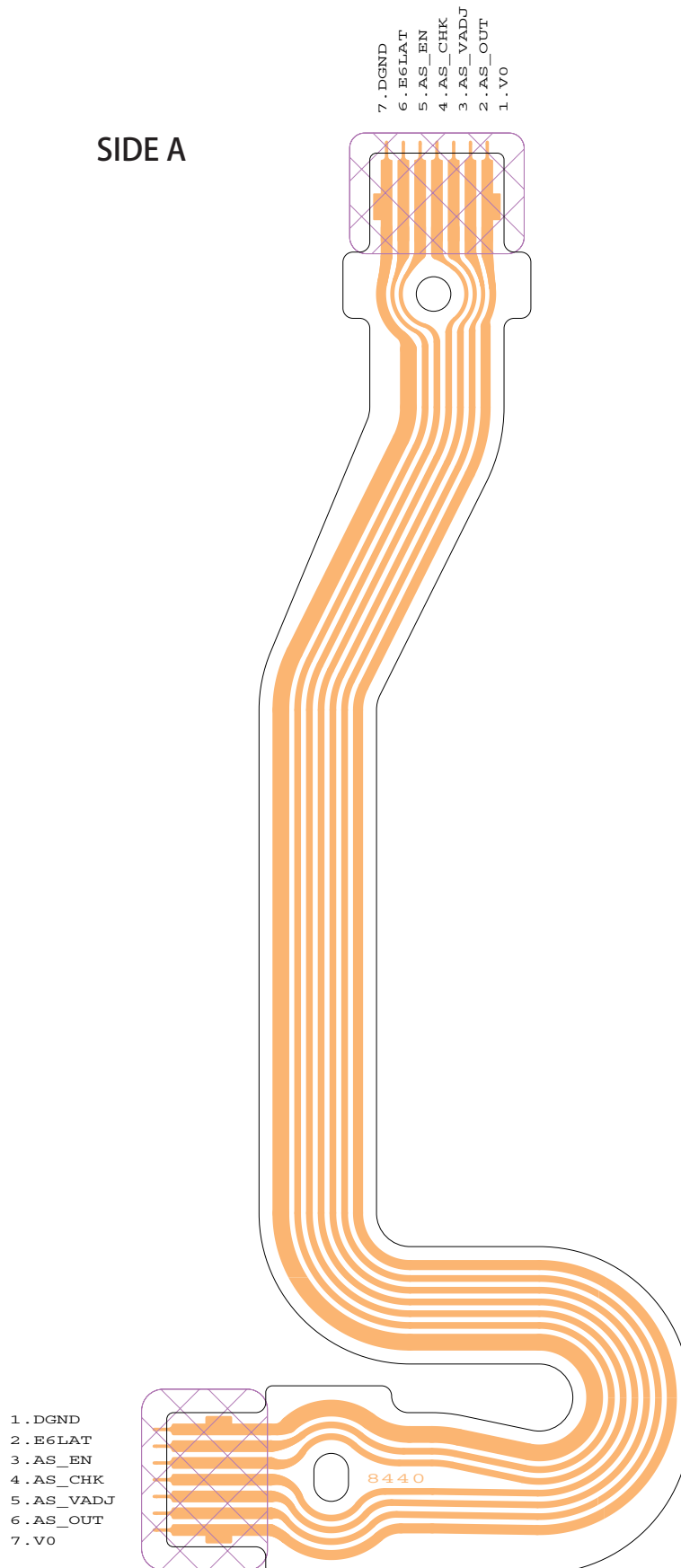

3. PCB DIAGRAM
3-9 BM FPC

REF. NO. C12-6151, 2
C12-6153, 4
C12-6155, 6

SIDE A

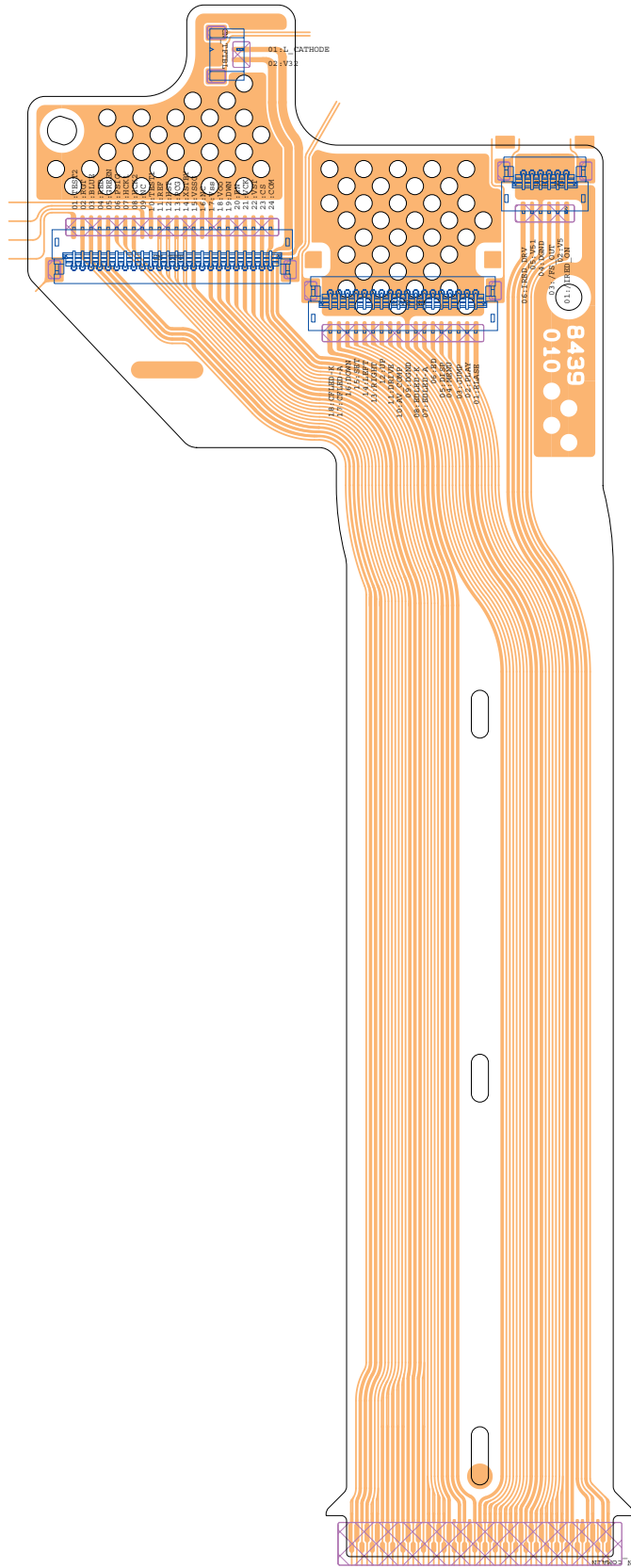

50	REFL_BUR	541 20	REFL_BUR
51	REFL_BUR	541 20	REFL_BUR
52	REFL_BUR	541 20	REFL_BUR
53	REFL_BUR	541 20	REFL_BUR
54	REFL_BUR	541 20	REFL_BUR
55	REFL_BUR	541 20	REFL_BUR
56	REFL_BUR	541 20	REFL_BUR
57	REFL_BUR	541 20	REFL_BUR
58	REFL_BUR	541 20	REFL_BUR
59	REFL_BUR	541 20	REFL_BUR
60	REFL_BUR	541 20	REFL_BUR
61	REFL_BUR	541 20	REFL_BUR
62	REFL_BUR	541 20	REFL_BUR
63	REFL_BUR	541 20	REFL_BUR
64	REFL_BUR	541 20	REFL_BUR
65	REFL_BUR	541 20	REFL_BUR
66	REFL_BUR	541 20	REFL_BUR
67	REFL_BUR	541 20	REFL_BUR
68	REFL_BUR	541 20	REFL_BUR
69	REFL_BUR	541 20	REFL_BUR
70	REFL_BUR	541 20	REFL_BUR
71	REFL_BUR	541 20	REFL_BUR
72	REFL_BUR	541 20	REFL_BUR
73	REFL_BUR	541 20	REFL_BUR
74	REFL_BUR	541 20	REFL_BUR
75	REFL_BUR	541 20	REFL_BUR
76	REFL_BUR	541 20	REFL_BUR
77	REFL_BUR	541 20	REFL_BUR
78	REFL_BUR	541 20	REFL_BUR
79	REFL_BUR	541 20	REFL_BUR
80	REFL_BUR	541 20	REFL_BUR
81	REFL_BUR	541 20	REFL_BUR
82	REFL_BUR	541 20	REFL_BUR
83	REFL_BUR	541 20	REFL_BUR
84	REFL_BUR	541 20	REFL_BUR
85	REFL_BUR	541 20	REFL_BUR
86	REFL_BUR	541 20	REFL_BUR
87	REFL_BUR	541 20	REFL_BUR
88	REFL_BUR	541 20	REFL_BUR
89	REFL_BUR	541 20	REFL_BUR
90	REFL_BUR	541 20	REFL_BUR
91	REFL_BUR	541 20	REFL_BUR
92	REFL_BUR	541 20	REFL_BUR
93	REFL_BUR	541 20	REFL_BUR
94	REFL_BUR	541 20	REFL_BUR
95	REFL_BUR	541 20	REFL_BUR
96	REFL_BUR	541 20	REFL_BUR
97	REFL_BUR	541 20	REFL_BUR
98	REFL_BUR	541 20	REFL_BUR
99	REFL_BUR	541 20	REFL_BUR
100	REFL_BUR	541 20	REFL_BUR

3. PCB DIAGRAM 3-10 DRSW FPC

REF. NO. C12-6151, 2
C12-6153, 4
C12-6155, 6

SIDE A

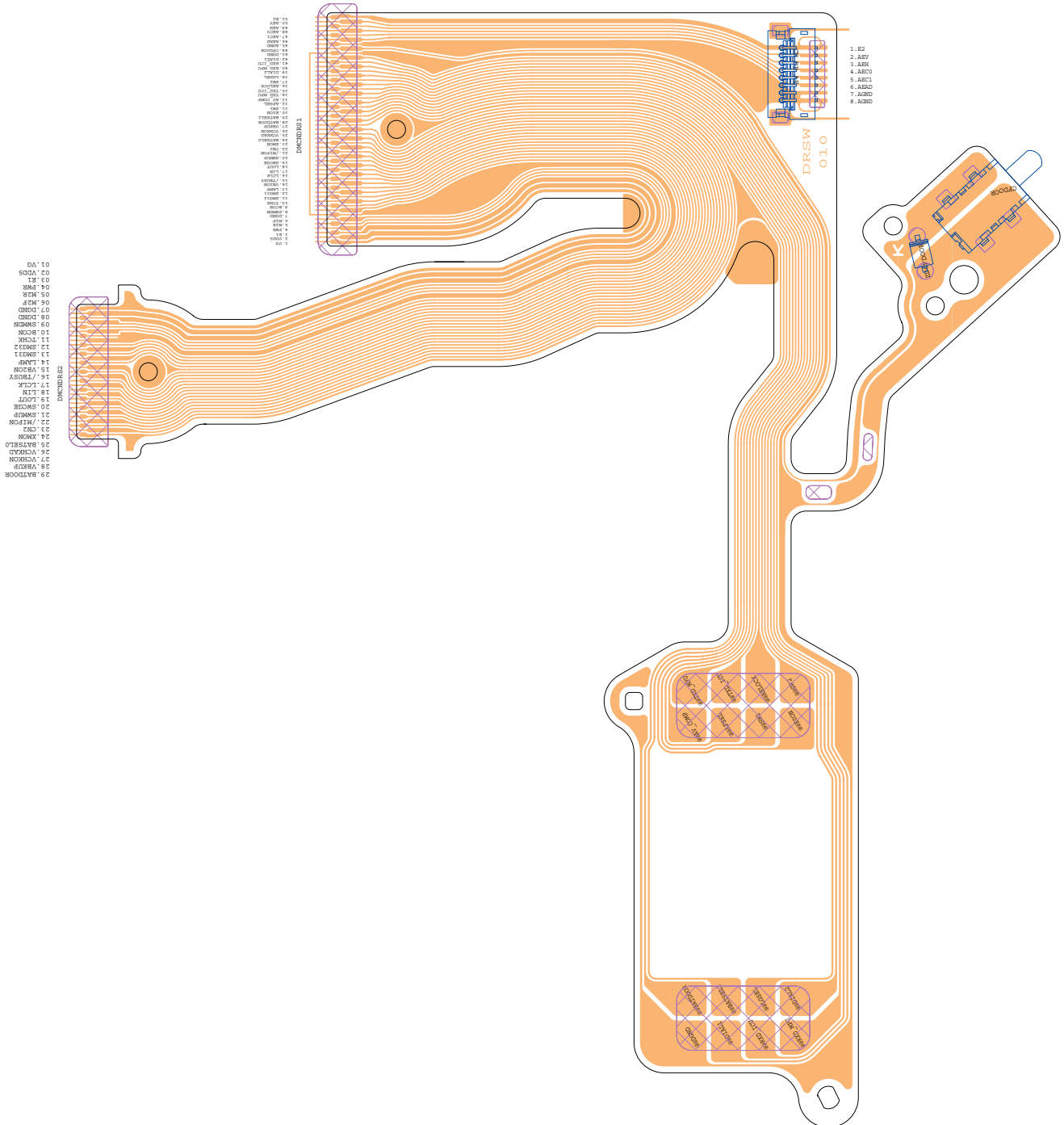

3. PCB DIAGRAM
3-11 FDS FPC

REF. NO. C12-6151, 2
C12-6153, 4
C12-6155, 6

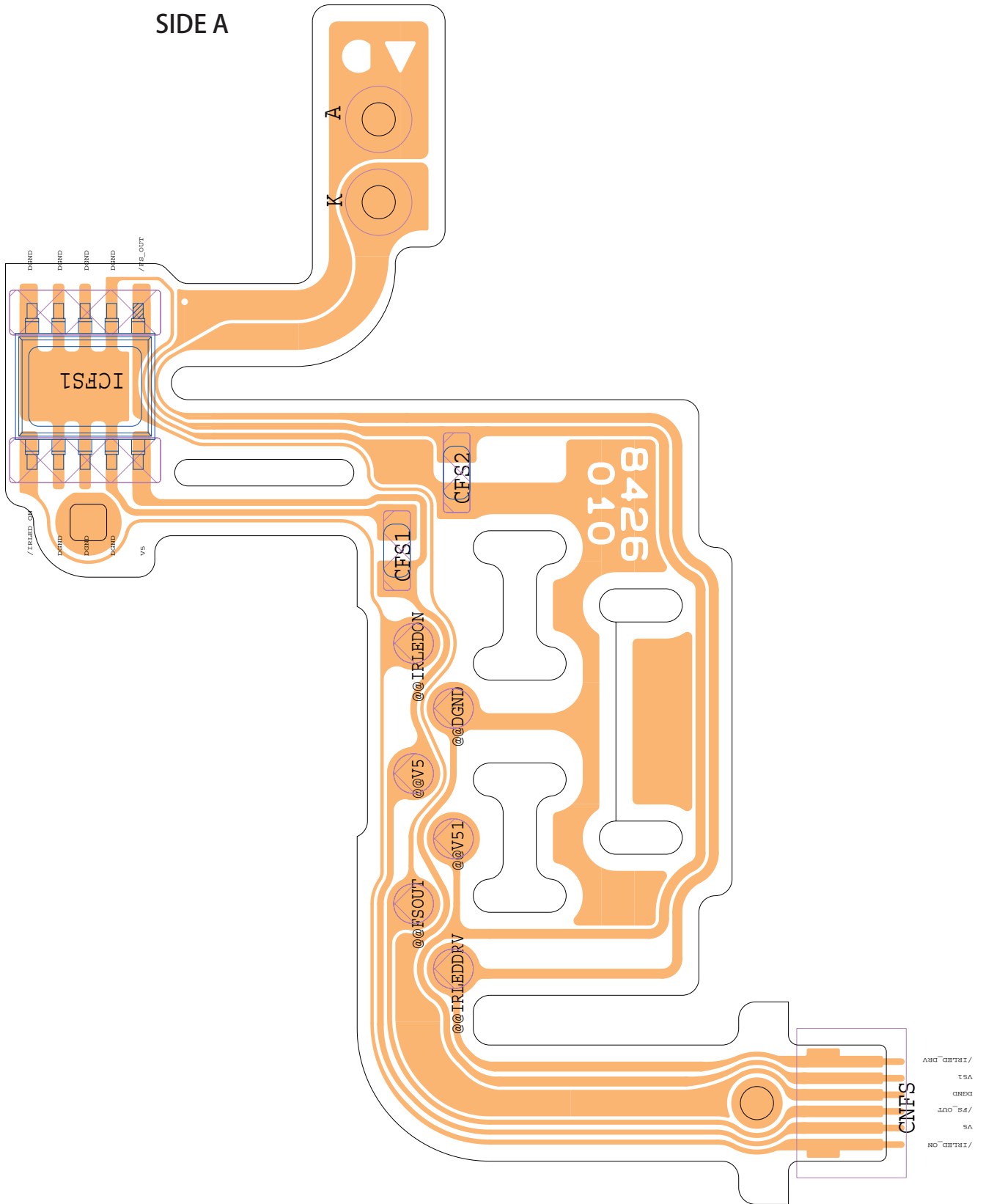

3. PCB DIAGRAM
3-12 IMGB FPC

REF. NO. C12-6151, 2
C12-6153, 4
C12-6155, 6

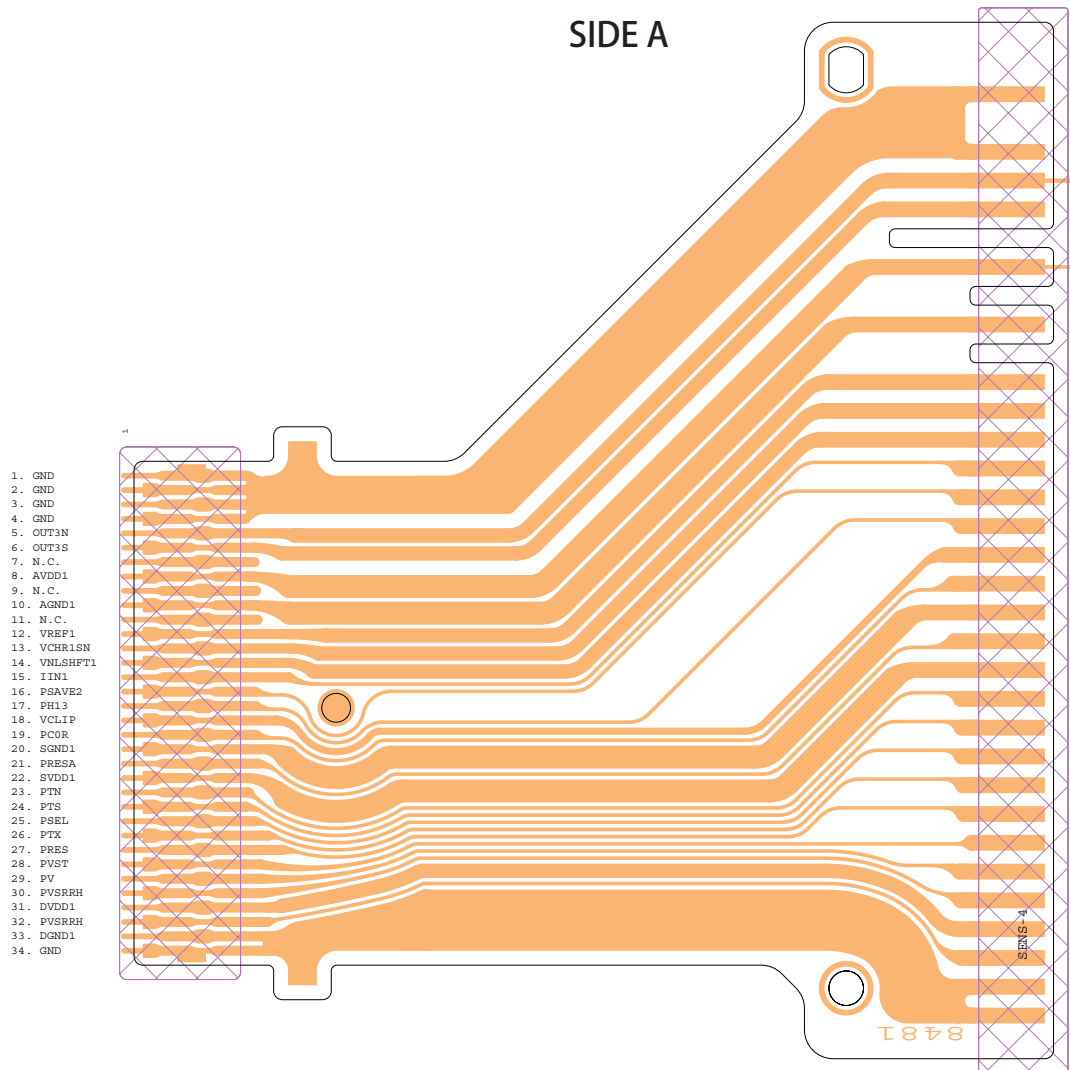

3. PCB DIAGRAM
3-13 IMGT FPC

REF. NO. C12-6151, 2
C12-6153, 4
C12-6155, 6

SIDE A

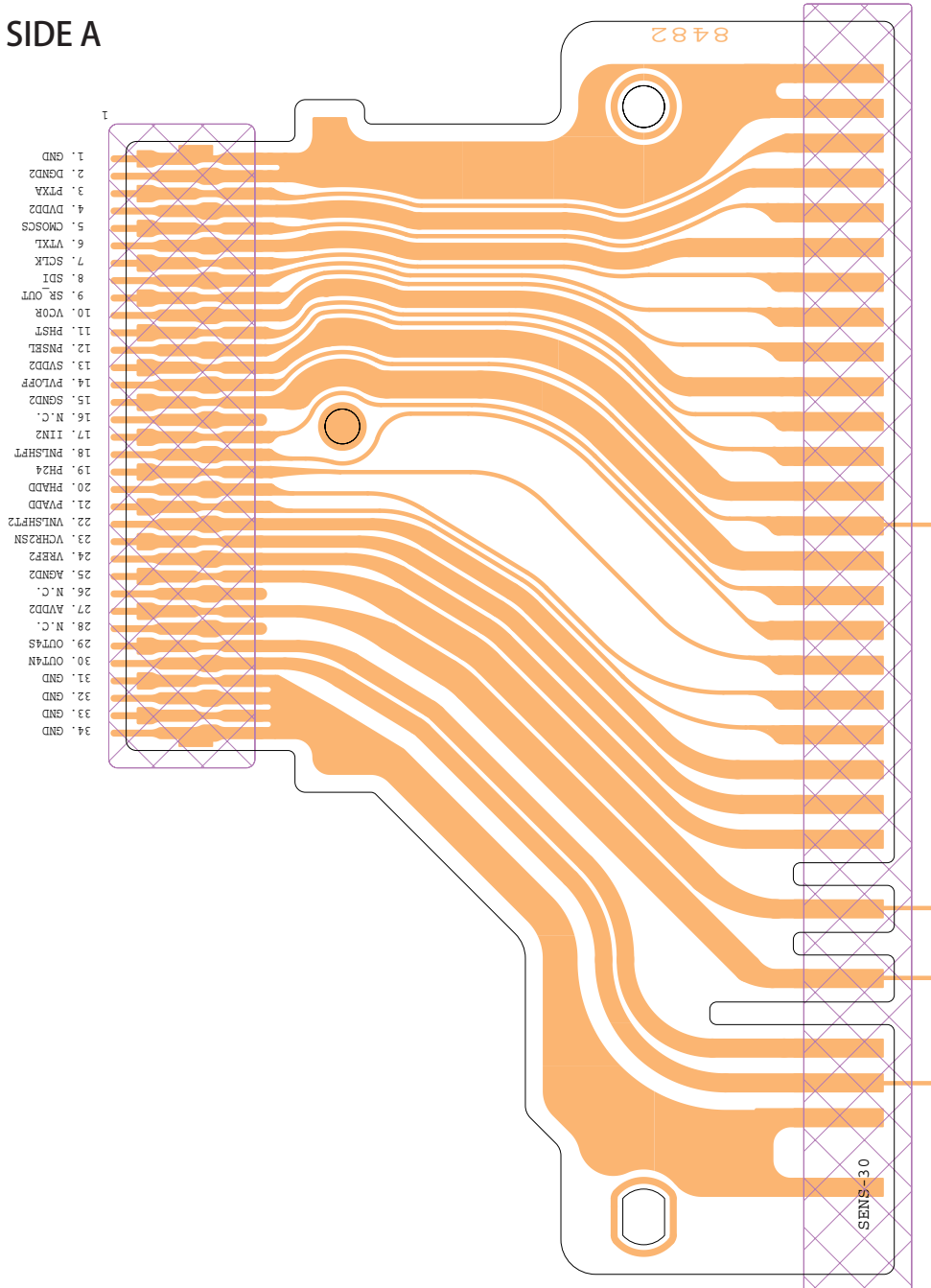

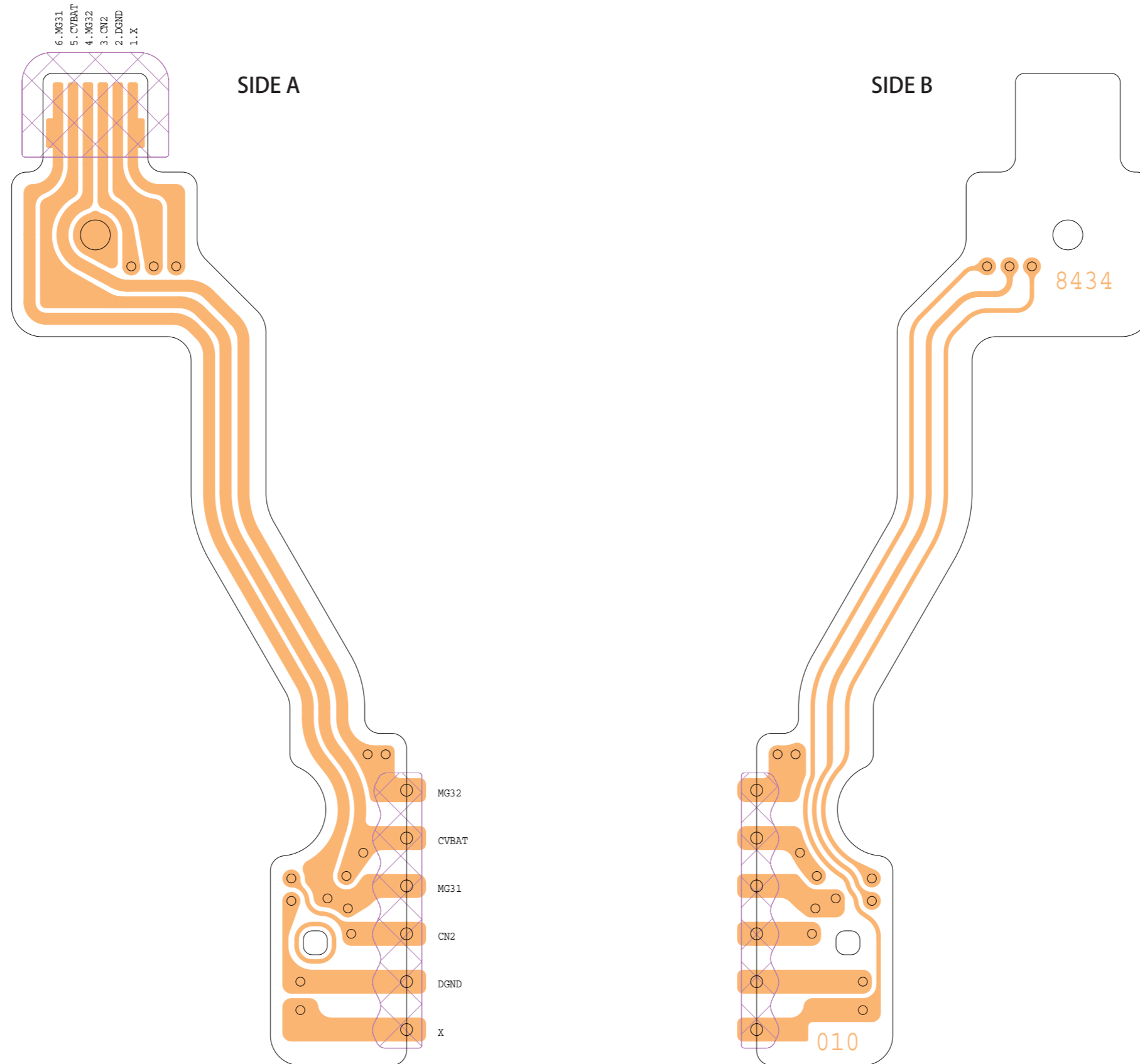

3. PCB DIAGRAM
3-15 SI FPC

REF. NO. C12-6151, 2
C12-6153, 4
C12-6155, 6

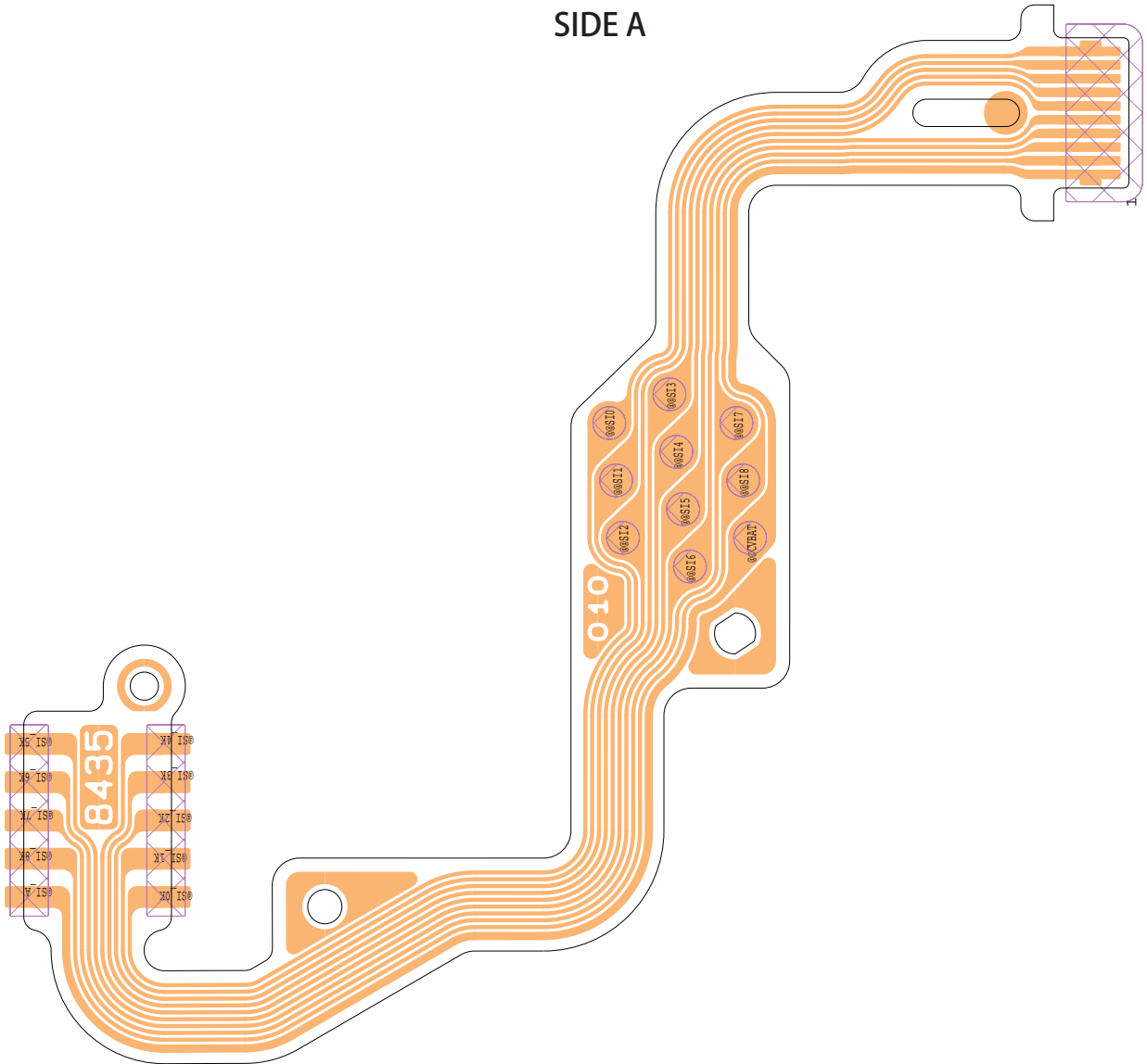

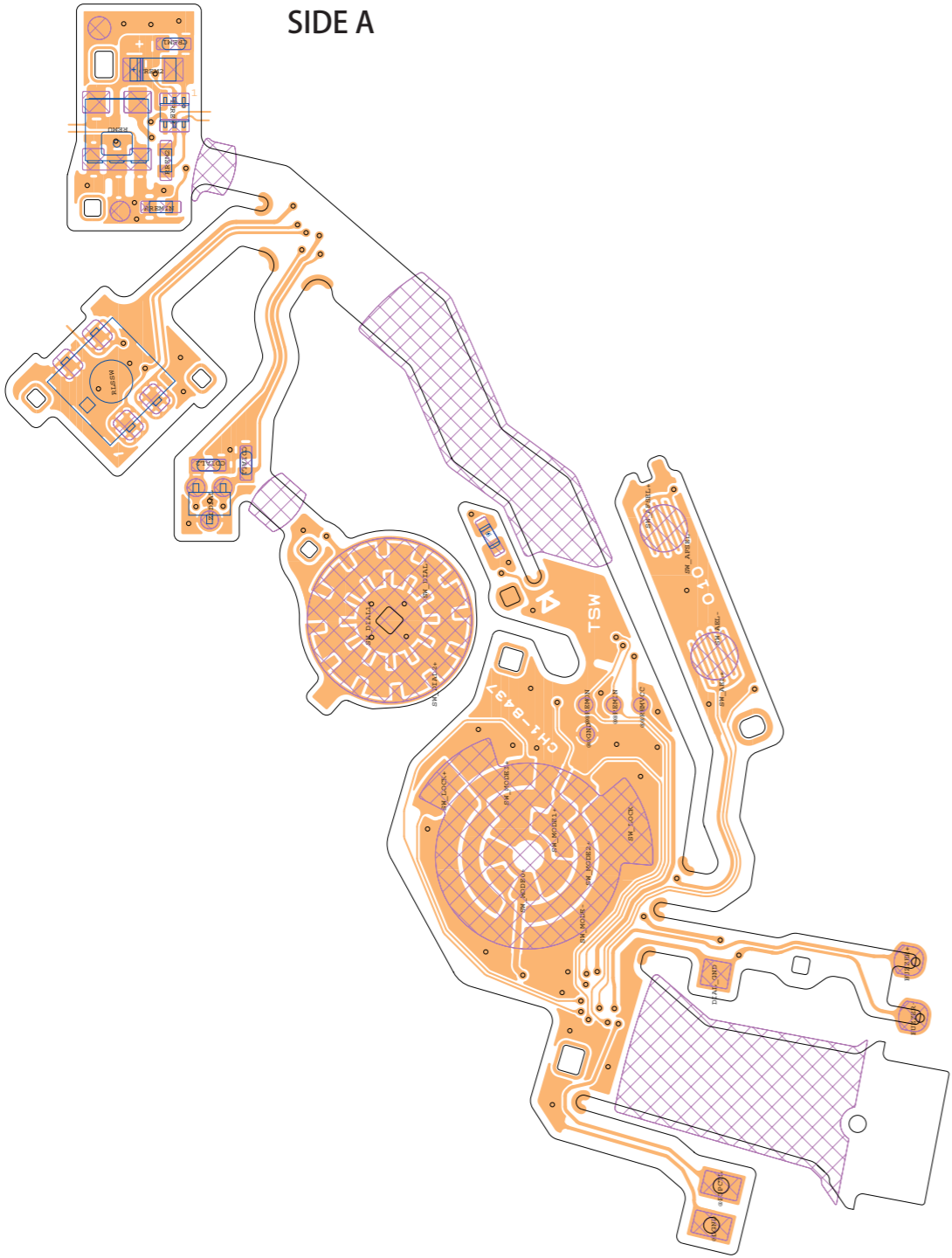

Software Information

Trademarks

The product names and company names described in this Service Manual are the registered trademarks of the individual companies.

Copyright

Canon Inc. retains the copyright to this Service Manual. Reproduction, publication (including on the World Wide Web), alteration, translation into another language, or other use of the data in whole or part, contained on this Service Manual without the written consent of Canon Inc. is prohibited.

CONTENTS

	Page
Software Information	
<hr/>	
1. EOS DIGITAL SOLUTION DISK Ver. 13	1
1.1 Development Objectives.....	1
1.2 Features	1
1.3 Software Configuration and System Requirements	4
1.4 Software Overview and Improvements	6

1. EOS DIGITAL SOLUTION DISK Ver. 13

1.1 Development Objectives

EOS DIGITAL Solution Disk Ver. 13 is EOS DIGITAL software based on Ver.12 that provides the upgraded functionality described below.

Apart from Digital Photo Professional and EOS Utility, the functions of Ver.12 are retained unchanged.

1.2 Features (blue text indicates features changed since Ver. 12.)

1) EOS Utility Ver. 1.1

- This is software for communicating with EOS DIGITAL cameras that enables you to download images from your camera to a PC, specify camera settings and take pictures remotely.
- Support for almost all EOS DIGITAL camera models
- Image downloading from the camera
 - Downloads all the images as a batch from the camera to a PC.
 - Displays a list of images saved on the memory card in the camera and downloads selected images.
 - Links with DPP or ZB/IB to check downloaded images immediately.
 - Also supports automatic image downloading using the Print/Share function.
- Specification of camera settings
 - Specifies basic information settings such as the owner name and the date/time.
 - Specifies settings for features such as Picture Style, processing parameters and personal functions, depending on the specifications of the connected camera.
- Remote shooting
 - Controls the camera and takes pictures remotely from a PC.
 - Specifies camera settings and releases the shutter.
 - Links up with DPP or ZB/IB to allow realtime checking of photographed images.
 - Equipped with timer photography and interval timer photography functions (with no limit on the maximum number of shots).
 - Also supports shooting by pressing the shutter button on the camera.
- Folder monitoring
 - Transfers images inside monitored folders to a specified folder.
 - Links up with DPP or ZB/IB to allow realtime checking of transferred images.
 - Allows photographed images to be checked in realtime in DPP or ZB/IB when the WFT-E1/E1A wireless transmitter is used.

2) Digital Photo Professional Ver. 2.2

- This is RAW image viewing/processing/editing software aimed primarily at high-end amateur and professional users who mostly shoot RAW images.
- High-speed processing of RAW images
 - High-speed RAW image display and processing using Canon's own powerful algorithms
 - Processing with high image quality using the latest genuine Canon algorithms
- Support for RAW images from almost all EOS DIGITAL camera models

- Also supports RAW images from the EOS D6000 and EOS D2000 that were converted using the CR2 converter.
 - *Does not support RAW images from the EOS DCS1 or EOS DCS3.
- Can also be used to view and edit JPEG and TIFF images.
- Easier control with basic functions tailored to professional workflows
 - Image display options to suit a range of applications
 - Thumbnail image list display from the main window
 - Quick check window that is useful for quickly checking the focus and image details
 - Edit window allows an image to be edited while being compared with other images
 - Edit image window that allows multiple images to be edited efficiently
 - Image selection using 3 types of check marks
 - Batch conversion/save (batch processing) and ICC profile addition for multiple RAW images
 - Image conversion and saving as TIFF or JPEG images and ICC profile addition
 - Support for all camera communication functions via linkage with the EOS Utility
 - Batch file renaming
 - Single-image transfer to Photoshop
 - Batch transfer of multiple images to third-party image editing software
- Extensive range of image editing functions
 - RAW image adjustment functions (processing parameter settings) that offer greater flexibility than the camera alone
 - Image adjustment that does not detract from image quality in RAW images
 - RAW image editing functions:
Brightness, white balance, Picture Style, contrast and dynamic range adjustment
 - RGB image editing functions (for RAW, JPEG and TIFF images):
[Automatic tone curve adjustment \(tone curve assist\)](#), tone curve, brightness, contrast, dynamic range, color and sharpness adjustment
 - Image rotation (90° to the left or right)
 - Trimming
 - [Automatic dust erasure \(using Dust Delete Data\)](#)
 - Dust erasure 1 at specified locations (repair)
 - Image correction (copy stamp)
 - RAW image noise reduction (3 levels for luminance noise and chrominance noise)
 - Chrominance noise reduction in JPEG and TIFF images (3 levels)
 - Saving, loading and batch application to other images of Recipe data (the editing data from multiple functions)
- Realtime display of image editing outcomes
 - Realtime image display of a range of adjustments
 - Realtime comparison display of edited images before and after editing
- Adobe RGB direct faithful printing for RAW images
 - Easy-PhotoPrint + Canon inkjet printer
 - Easy-PhotoPrint Pro + new Canon inkjet printer (to be released in 2006)
 - Dedicated Plug-In software + new Canon L printer (to be released in 2006)
- 3 printing style specification functions
 - Single-page printing (automatic settings), Single-page printing (shooting information, captioning, flexible layout), contact sheet printing
- Color management
 - Support for Color Management System

- Support for 5 types of color space
sRGB, Adobe RGB, Apple RGB, ColorMatch RGB, Wide Gamut RGB
- Addition of ICC profiles to saved images
- Monitor and printer profiles designatable
- CMYK simulation function that simulates CMYK environment color tones

3) ZoomBrowser EX Ver. 5.7 (Windows)/ImageBrowser Ver. 5.7 (Macintosh)

- Image viewing/editing software aimed squarely at novice to high-end amateur users who mainly shoot JPEG images
- Simple and straightforward interface
 - Uses task buttons and step-by-step procedures with novice Windows users in mind.
*ImageBrowser is menu-driven.
- Workflow-compatible from image downloading through to printing
 - Links up with other applications to provide a continuous workflow from image downloading and viewing right through to editing and printing.
- Image display options to suit a range of applications
 - 3 types of image list display (Zoom, Scroll and Preview)
 - "Viewer window" with individual image display and multiple-image comparison display
 - Slide show display
- Convenient image management functions
 - Image classifying by shooting date/time
 - Batch file renaming
 - [Image selection](#) according to "Rating", "My category" or "Keyword" ([Filter function](#))
 - Image searching by shooting date, modification date, rating, "My category", comment or keyword
- Extensive range of JPEG image editing functions
 - Red-eye reduction, automatic image adjustment, color and brightness (color adjustment, levels adjustment and tone curve), sharpness, trimming, captioning
 - Image rotation (90° to the left or right, or rotation by 180°)
 - Image transfer to third-party image editing software
- Panorama image merging
 - Automatic merging of panorama shots by linking with PhotoStitch
- RAW image processing that conforms to the camera processing
 - RAW image processing by linking with RAW Image Task
 - Processing that conforms to the camera's image processing characteristics
- Simple print functions matched to a range of applications
 - Single-page printing (automatic settings)
 - Index printing
 - Printing with Easy-PhotoPrint
- Extensive range of image exporting functions
 - Converting and saving JPEG images as BMP or TIFF images
 - Exporting of shooting information
 - Exporting images as screensavers or wallpaper
 - Writing images to CD-R or CD-RW
- Various types of connection to Canon iIMAGE GATEWAY
- Linking with e-mail software to send images as e-mail attachments
- Support for Color Management System
 - Supports 2 types of work color space (sRGB and Adobe RGB)

4) RAW Image Task Ver. 2.4

- RAW image processing software linked to ZB/IB
 - Allows RAW images selected in ZB/IB to be processed and displayed in RAW Image Task
 - Allows the user to apply image adjustments to RAW images (using processing parameter settings) with no loss of image quality
- Processing faithful to the camera
 - Algorithms tailored to the camera ensure that images are processed with the same processing characteristics as those used on the camera.
 - Allows the user to set the same processing parameters used on the camera or use modified parameters.
- Support for RAW images from almost all EOS DIGITAL camera models
 - * RAW images from the EOS D6000, EOS D2000, EOS DCS1 and EOS DCS3 are not supported.
 - * EOS D6000 and EOS D2000 RAW images converted using the CR2 converter are also not supported.
- Image conversion/saving as TIFF or JPEG images and the addition of ICC profiles
- Support for Color Management System
 - Support for 2 types of work color space (sRGB and Adobe RGB)

5) PhotoStitch Ver. 3.1

- JPEG image merging software linked to ZB/IB
 - Uses simple procedures to create composite images such as panorama shots.
 - Uses a wizard-type interface that caters to novice users.

6) CameraWindow MC Ver. 6.3

- Image downloading software for use with card readers linked to ZB/IB.

1.3 Software Configuration and System Requirements

1) Configuration

EOS DIGITAL Solution Disk Ver. 13 consists of the software applications shown below, which are unchanged from version 12. Note that EOS Utility is not compatible with Macintosh using Intel processor (Mac OS X10.4.4 to 10.4.6), due to OS's program error (as of June 2006).

Table 001 EOS DIGITAL Solution Disk Ver. 13 Software Configuration

	Name	Ver.	Windows OS	Mac OS	
				Power PC	Intel
①	EOS Utility	1.1	○	○	—
②	Digital Photo Professional	2.2	○	○	○*1
③	ZoomBrowser EX	5.7	○	—	—
④	ImageBrowser	5.7	—	○	○*2
⑤	RAW Image Task*3	2.4	○	○	○*2
⑥	PhotoStitch	3.1	○	○	○*2
⑦	CameraWindow MC	6.3	○	○	○*2
⑧	PTP WIA Driver/PTP TWAIN Driver	1.3	○	—	—

* 1 : Because it uses UB (Universal Binary) to provide native-level compatibility, it will run at the speed of a native application on Macintosh machines with Intel CPUs.

* 2 : Because compatibility is provided through emulation, it does not run as fast as UB-compatible software.

* 3 : Cannot be launched as a standalone application. Functions with or is launched by ③ or ④.

2) Modes and Supported Cameras

EOS DIGITAL Solution Disk Ver. 13 consists of a single CD that contains software applications ① through ⑧ described in "1) Configuration". The software is available in 7 languages: Japanese, English, French, German, Italian, Spanish and Chinese (simplified). As with Solution Disk Ver. 12, version 13 is available in 3 region-specific versions (Table 002).

Table 002 Region-specific Versions of Solution Disk and the Supported Languages

Region-specific Versions of Solution Disk	Japanese	English	Chinese	French	Spanish	German	Italian
Japan, China, Asia	○	○	○	—	—	—	—
North/South America, Europe	—	○	—	○	○	—	—
Europe	—	○	—	—	—	○	○

EOS DIGITAL Solution Disk Ver. 13 will be included only in the EOS D REBEL XTi / EOS 400D D camera. All applications in EOS DIGITAL Solution Disk Ver. 13 will be uploaded in the Canon's web site as usual, so that the users can download them.

The EOS DIGITAL Solution Disk Ver. 13 Instruction Manual (PDF) will be supplied on a separate documentation CD.

3) System Requirements

Tables 003 and 004 show the system requirements for each software application. There are no changes from version 12 other than in the Macintosh versions of the software, all of which will now run on Macintosh machines with Intel CPUs (except for EOS Utility).

Table 003 System Requirements for Windows

Software	EOS Utility	Digital Photo Professional	ZoomBrowser EX, CameraWindow MC, RAW Image Task, PhotoStitch
OS	Windows XP (Home Edition/Professional), Windows 2000		Windows XP (Home Edition/Professional), Windows Me, Windows 2000, Windows 98SE
Model	PC equipped with an OHCI-compliant IEEE1394 port or USB port as a standard feature and one of the above OS pre-installed * Upgraded machines not supported.	PC with one of the above OS pre-installed * Upgraded machines not supported.	
CPU	750 MHz Pentium III or higher		500 MHz Pentium or higher
RAM	Minimum 256 MB		Minimum 256 MB
Interface	USB 1.1 to 2.0 Hi-Speed, IEEE1394		
Display	Screen resolution: 1024 × 768 pixels or more; Colors: Medium (16 bit) or more		

Table 004 System Requirements for Macintosh

Software	EOS Utility	Digital Photo Professional	ImageBrowser, CameraWindow MC, RAW Image Task, PhotoStitch
OS	Mac OS X 10.2 to 10.4		
Model	Macintosh equipped with a FireWire (IEEE1394) port or USB port as a standard feature and one of the above OS installed	Macintosh with one of the above OS installed	
CPU	400 MHz Power PC G3 or higher, G4, G5 or Intel processor		Power PC G3, G4, G5 or Intel processor
RAM	Minimum 256 MB	Minimum 512 MB	Minimum 256 MB
Interface	USB 1.1 to 2.0 Hi-Speed, IEEE1394		
Display	Resolution: 1024 × 768 pixels or more; Colors: Thousands or more		

* USB 2.0 Hi-Speed is supported on the EOS D REBEL XTi / EOS 400D D, EOS 5D, EOS 30D, EOS 20D and EOS DIGITAL REBEL XT/350D DIGITAL.

* The Macintosh UFS (UNIX File System) format is not supported.

* EOS Utility is not compatible Macintosh using Intel processor (Mac OS X10.4.4 to 10.4.6).

1.4 Software Overview and Improvements

The details of the upgrades to each of the software applications are described below.

1) EOS Utility Ver. 1.1

This is EOS DIGITAL software that enables you to download images from your camera to a PC, specify camera settings and take pictures remotely. This version is based on version 1.0 and incorporates the following improvements.

(1) Specification of any program as associated retouching software

The options for associated software have been expanded so that any application (e.g. Photoshop) can be selected, not just DPP or ZB/IB. The setting is specified in the Preferences window.

(2) Removal of the limit on the maximum number of shots in timer photography

The limit on the maximum number of shots that can be taken in timer photography or interval timer photography has been removed. This function has been upgraded so that the only limit on the number of shots you can take is the amount of available hard disk space on the connected PC.

* The maximum number of available shots in version 1.0 was matched to the numbers shown on the camera's display panel. This limited the number to 1,999 shots on EOS-1D series cameras and 999 shots on all other cameras. However, in response to user demand for the removal of the limit on the maximum number of available shots, the limit has been removed in version 1.1.

(3) Addition of remote control for the camera's Auto Power Off setting

To make remote shooting easier to use, the Auto Power Off Enable/Disable setting was added to the Preferences window.

(4) Addition of a function that displays the folder in which images are saved

A save destination folder display function has been added to make it easier for you to locate the folders containing the images downloaded to the PC. To view the folder containing downloaded images, select "Open save destination" from the "File" menu in the "image download window" or "Camera settings/Remote shooting window".

Note that EOS Utility is not compatible with Macintosh using Intel processor (Mac OS X10.4.4 to 10.4.6), due to OS's program error (as of June 2006). Since Apple is already aware of this program error, so this problem will probably be settled when the OS is updated to 10.4.6 or later and Macintosh using Intel processor will be compatible with EOS Utility.

2) Digital Photo Professional Ver. 2.2

This is image viewing/processing/editing software for EOS DIGITAL RAW images and is ideal for users who work primarily with RAW images. This version is based on version 2.1 and incorporates the following improvements.

(1) Incorporation of an automatic dust erasure processing function that supports EOS D REBEL XTi / EOS 400D D Dust Delete Data

Version 2.1 included a "Repair" function that enables users to manually remove dots caused by dust. In version 2.2, this function has been extended so that it now includes an automatic dust erasure processing function which uses the Dust Delete Data. In automatic dust erasure processing, images provided with Dust Delete Data (RAW or JPEG images) are opened in a Copy Stamp window and you simply press the [Apply Dust Delete Data] button to initiate automatic dust erasure. (Fig. 001)

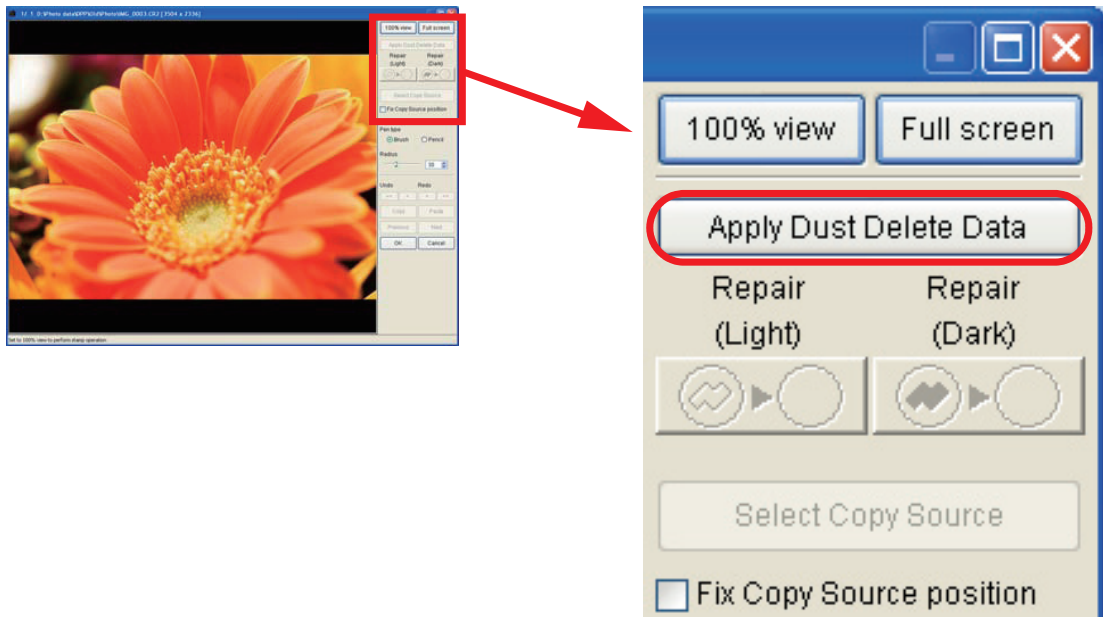

Fig. 001 [Apply Dust Delete Data] button in the Copy Stamp window

By pressing the <Shift + F> or <Shift + B> keys (for Macintosh, <F> or key), the dust erased spots are enlarged one by one for you to check them. And you can cancel only the displayed dust-erased spot by pressing the <Shift + Del> keys.

You can also process multiple images with attached Dust Delete Data in a batch by selecting the images to be processed in the main window and then selecting [Apply Dust Delete Data] from the [Adjustment] menu.

Automatic dust erasure processing checks the locations on the image where dust is recorded in the Dust Delete Data and applies dust erasure to those locations identified as being dust. This means that dust that has moved since the Dust Delete Data was acquired is not removed. Likewise, this function cannot remove dust that has appeared after the Dust Delete Data was acquired.

(2)Enhanced Tone Curve Assist function (standard/high)

The tone curve assist function provided in version 2.1 has been enhanced with the addition of a mode that applies the function more strongly. The automatic adjustment function has been expanded so that there are now 2 buttons, one for the existing tone curve adjustment (Standard) and one for the stronger adjustment (High). (Fig. 002)

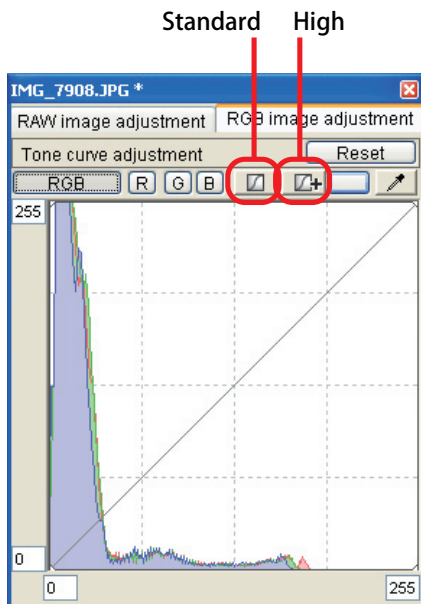
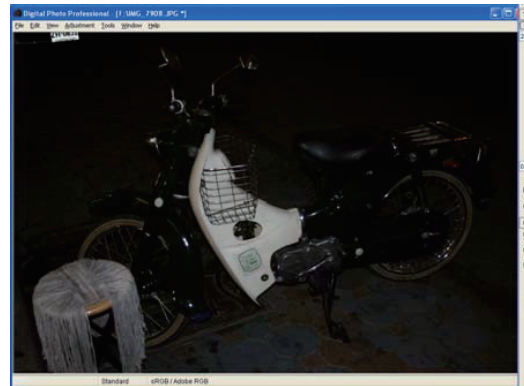
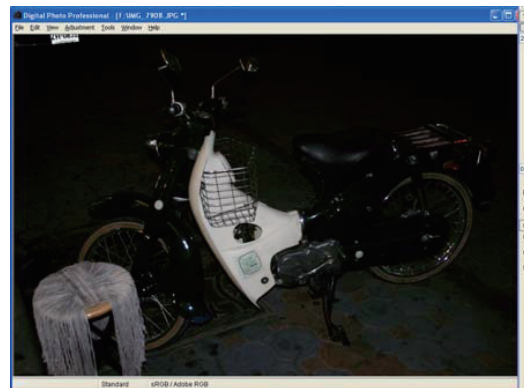

Fig. 002 RGB image adjustment tool palette

Original image



Standard



High

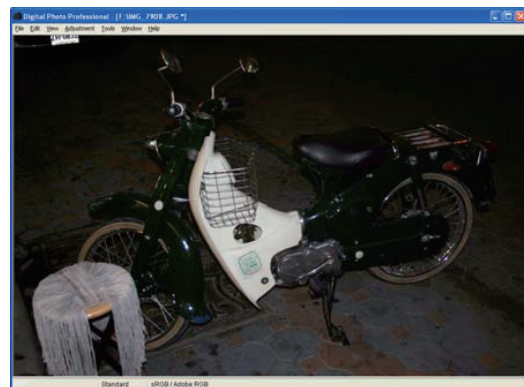

Fig. 003 Images comparing the effects of tone curve assist

(3) Addition of a noise reduction function for JPEG images

The chrominance noise reduction function for RAW images in version 2.1 has been expanded so that it can now be applied to JPEG and TIFF images also. (Fig. 004) This makes it possible to obtain JPEG and TIFF images with even better image quality than previously. The adjusted data can be applied either by overwriting the original image or by creating a copy under a different name.

- * Chrominance noise: Noise that appears as colored smears or smudges in images shot at high ISO speeds or in shadowed areas of images shot at low ISO speeds.
- * To check the noise reduction outcomes in DPP, set the "Operating mode" in the Preferences window to "Quality priority".

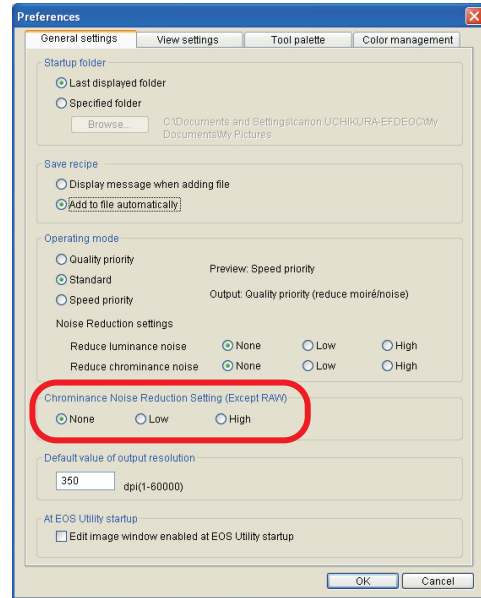

Fig. 004 Noise reduction settings for JPEG and TIFF images in the Preferences dialog box



Fig. 005 Sample images comparing the effect of chrominance noise reduction

3) ZoomBrowser EX Ver. 5.7

This image viewing/editing software is ideal for ordinary Windows users who primarily work with JPEG images. This software is bundled with all Canon digital camera models. This version is based on version 5.6 and incorporates the following improvements.

- Addition of a filtering function that supports the "My category" function provided on Canon compact digital cameras

*The "My category" function appends image classification tags to photographed images. By using the "My category" specified to each image to filter images, users can restrict the images displayed in ZB/IB.

*The "My category" function is not provided on EOS DIGITAL cameras.

4) ImageBrowser Ver. 5.7

The image viewing/editing software that is ideal for ordinary Macintosh users who primarily work with JPEG images. This software is bundled with all Canon digital camera models. This version is based on version 5.6 and incorporates the same improvements that are provided in ZoomBrowser EX.

5) Raw Image Task Ver. 2.4

This is RAW image processing software that runs in conjunction with 3) or 4). This software is also bundled with all Canon digital camera models equipped with a RAW image photography function. The only change from version 2.3 is the addition of the EOS D REBEL XTI / EOS 400D D to the list of supported RAW image files.

6) PhotoStitch Ver. 3.1

This is JPEG panorama image merging software that runs in conjunction with 3) or 4). This software is bundled with all Canon digital camera models. This is the same version as the software bundled with all Canon digital cameras released in Spring 2006.

7) CameraWindow MC Ver. 6.3

This is image downloading software for use with card readers and runs in conjunction with 3) and 4). This software is bundled with all Canon digital camera models. This version is based on version 6.1 and incorporates the following improvements.

- Discontinuation of thumbnail image display during image transfer (for operational stability)

8) PTP WIA Driver Ver. 1.3/PTP TWAIN Driver Ver. 1.3

This is software for controlling communication between the camera and Windows PCs. If this driver is not installed, the camera cannot communicate with Windows PCs.

*When an EOS 5D, EOS 30D or EOS D REBEL XTI / EOS 400D D is connected to a PC running Windows XP, there is no separate driver as the OS functions are used.

Appendix

Trademarks

The product names and company names described in this Service Manual are the registered trademarks of the individual companies.

Copyright

Canon Inc. retains the copyright to this Service Manual. Reproduction, publication (including on the World Wide Web), alteration, translation into another language, or other use of the data in whole or part, contained on this Service Manual without the written consent of Canon Inc. is prohibited.

CONTENTS

	Page
Appendix	
1. INHIBIT VOLTAGE MEASURING PROCEDURE	1
1.1 Preparation of Resistance Part	1
1.2 Total Resistance Checking Procedur	1
1.3 Checking Procedure of Residual Battery Display	3
2. FACTORY DEFAULT SETTINGS	4
3. EXTERIOR COLOR COMPARISON	5
4. MOUNTING PICTURES	6
EOS D REBEL XTI / EOS 400D D SI POSITION CHECK CHART	

1. INHIBIT VOLTAGE MEASURING PROCEDURE

We hereby provide you with supplementary explanation for preparation of the tool battery used for residual battery display and measurement of power current consumption.

Service Manual mentions "0.40 ohm" only; however, this 0.40 ohm actually means total resistance including wire resistance and contact resistance or equivalent value to battery's internal resistance. Therefore, we introduce the procedures for tool battery preparation and measurement of total resistance.

1.1 Preparation of Resistance Part

1) What to prepare

- (1) Film case × 1
- (2) Probe × 1
- (3) Joint plug × 1
- (4) 0.5 ohm, 5W resistance × 2 (Bundled with CY9-1101-000 TOOL BATTERY PROBE KIT)

2) Procedure

- (1) Prepare above parts.
- (2) Make holes in the cover and the bottom of the film case to attach plugs. Insert the joint plug [A'] into the bottom hole and fix it with supplied washer from inside.
- (3) Solder two 0.5 ohm resistances in parallel together, place it inside the film case and solder the end of the resistance [A] to the joint plug [A'] inside the film case
- (4) Solder the other side of the resistance [B] to the probe [B'] inside the film case.

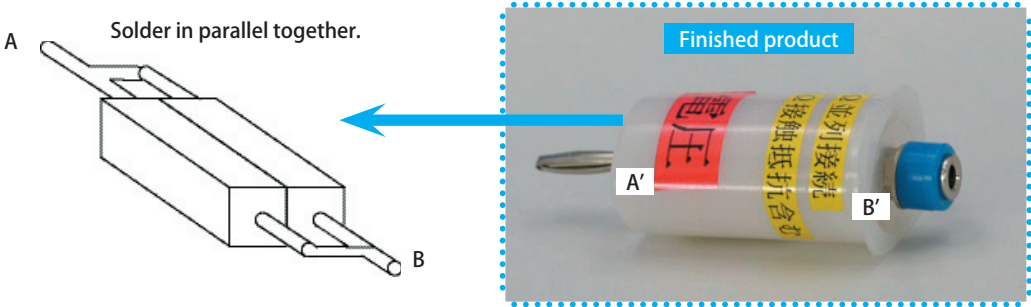

1.2 Total Resistance Checking Procedure

Here is the procedure to make sure that the resistance part and the tool battery make 0.41-0.49 ohm (target of 0.45 ohm).

1) What to prepare

- (1) CY9-7121-000 BATTERY CHECKER × 1
- (2) BATTERY CHARGER CB-2LT × 1
- (3) Constant voltage power source × 1
- (4) Tester × 1
- (5) Resistance part × 1
- (6) Tool battery CY9-7125 × 1



2) Remodeling of BATTERY CHARGER CB-2LT

- (1) Cut off the battery contact part of the battery charger with a cutting tool.
- (2) Solder lead wires to + and - of the battery contact and attach the probes to each end.

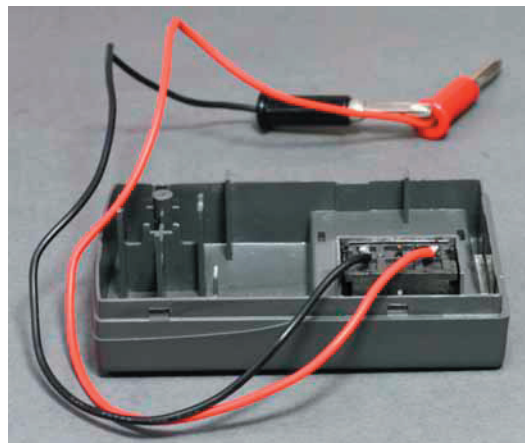
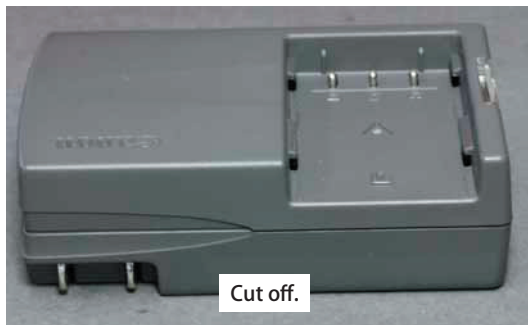

3) Modification of Tool Battery

Cut a part of the battery charger so that it becomes the same configuration as that of the battery.

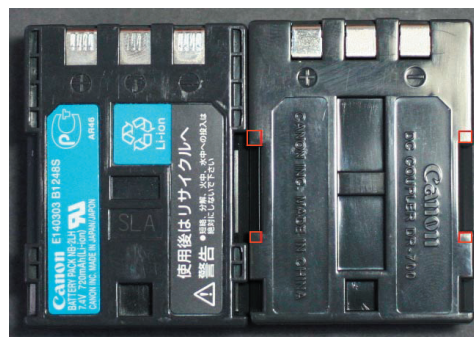

4) Measurement of Total Ohmic Value

- (1) Connect the resistance part and the tool battery to the constant voltage power source.
- (2) Connect the remodeled version of BATTERY CHARGER CB-5L to BATTERY CHECKER.
- (3) Attach a battery to the remodeled version of BATTERY CHARGER CB-5L.
- (4) Press the start button of BATTERY CHECKER.
- (5) Measure the voltage between the electrode sections (+ and -) of the remodeled CB-5L.
- (6) RESULT: 10V - the voltage between electrode sections (+/-) = Total ohmic value
(1A electric current is supplied for BATTERY CHECKER. Therefore, above difference in voltage will be the ohmic value.)

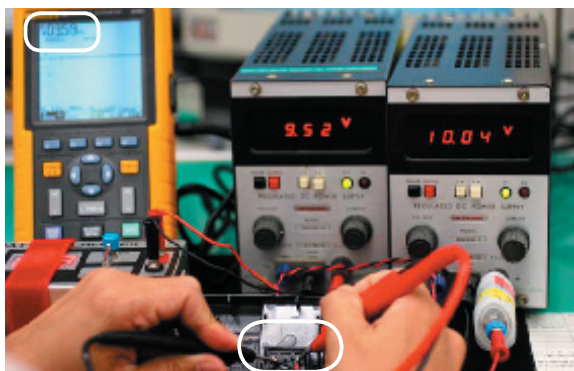

Make sure 10V is supplied to the tool battery.



Measure the voltage between the electrode sections (+ and -).

2. FACTORY DEFAULT SETTINGS

Item	Setting		
	JAPAN	North America	Europe and others
Image-recording quality	Large Fine		
Red-eye On/Off	Off		
Beep	On		
Shoot w/o card	On		
AEB	±0		
Flash exp comp	±0		
White Balance	AWB		
WB SHIFT/BKT	±0		
Custom WB	Factory Default Data		
Color space	sRGB		
Picture Style	Standard		
Dust Delete Data	No Data		
Review time	2 sec.		
Histogram	Brightness		
Auto power off	30 sec.		
Auto rotate	On(Camera, Monitor)		
LCD brightness	4		
LCD auto off	Enable		
Date/Time	yy/mm/dd	mm/dd/yy	dd/mm/yy
(Date/Time Writing)	YES	NO	NO
Backup Battery	Assembled	Assembled	Assembled
File numbering	Continuous		
Language	Japanese	English	English
Video system	NTSC	NTSC	PAL
Custom Functions	None		
Sensor cleaning	Auto		
AF mode	ONE SHOT		
Metering	Evaluative metering		
ISO Speed	100		
Communication	Print/PTP		
TV Value	1/125		
AV Value	5.6		
Drive mode	Single shot		
AF points	Auto selection		
Exposure compensation	±0		
Image Display Format	Normal (Single image +TvAv)		

*1

*2

*3

●Settings will differ depending on the destination. (*1-3)

Date and Time for Japan: Japan Standard Time

Date and Time for Overseas: Not stipulated

3. EXTERIOR COLOR COMPARISON

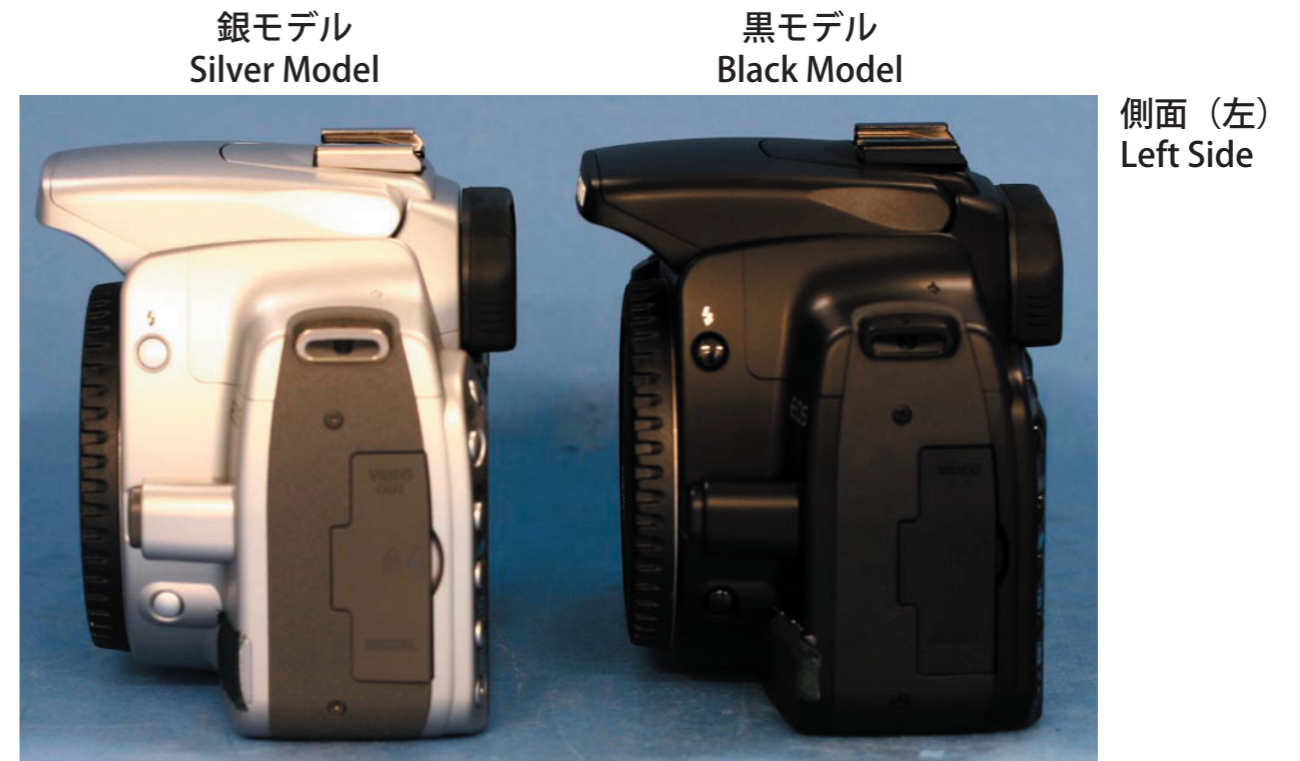
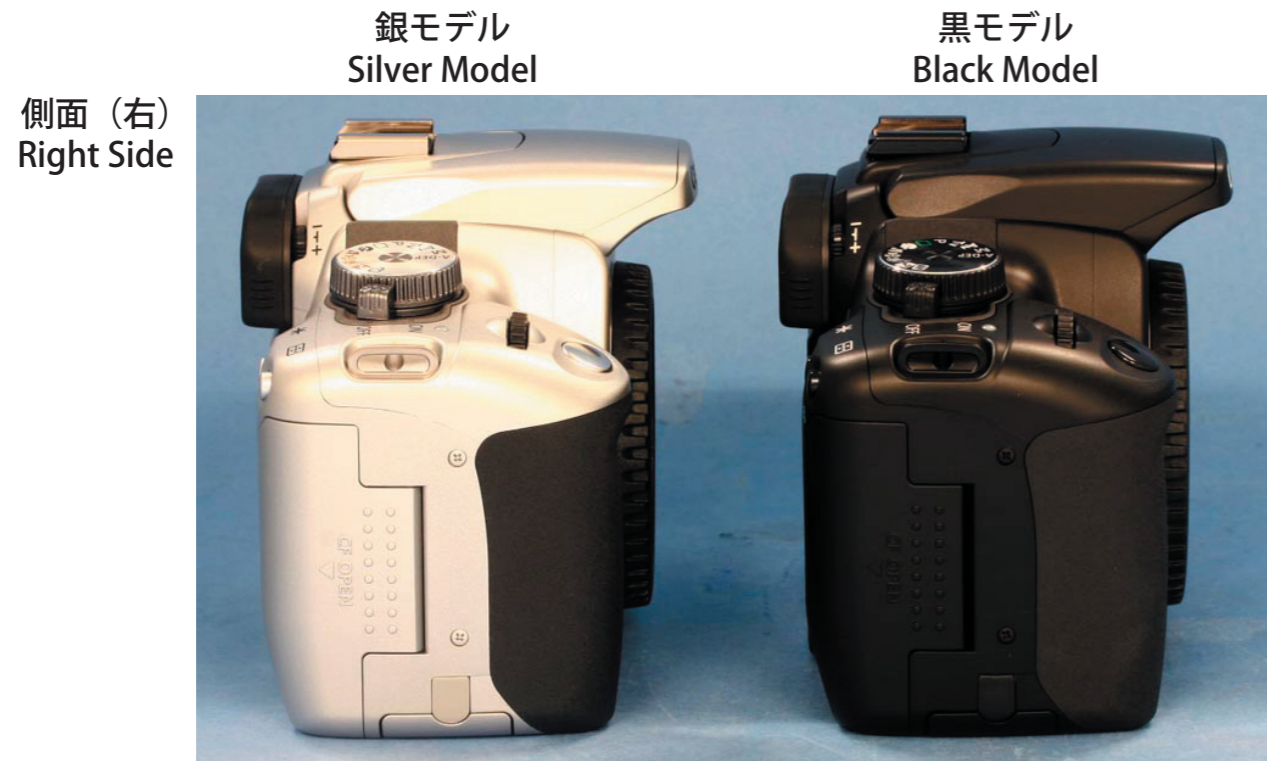

4. MOUNTING PICTURES

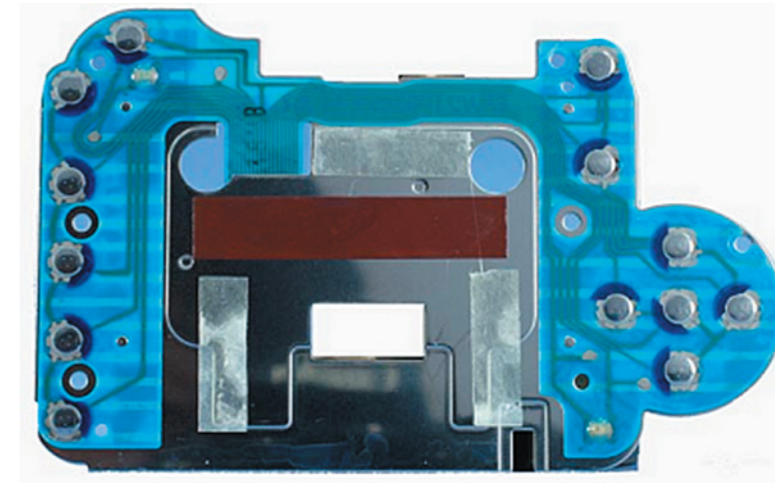
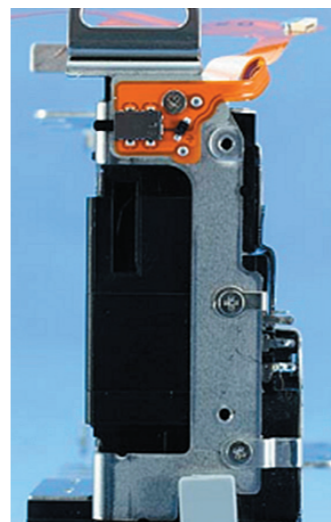
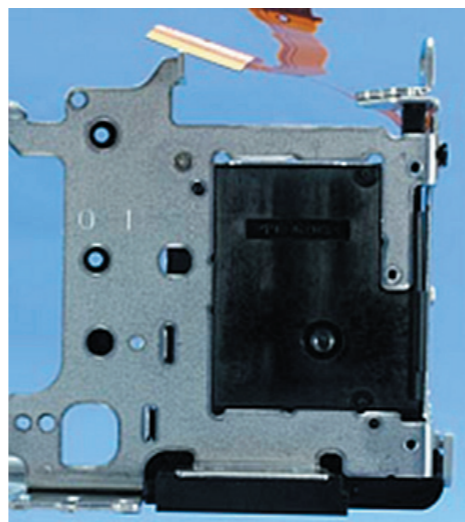
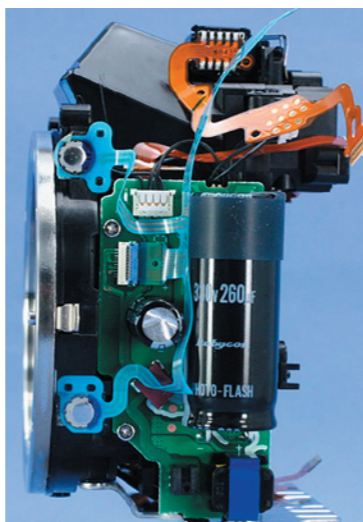
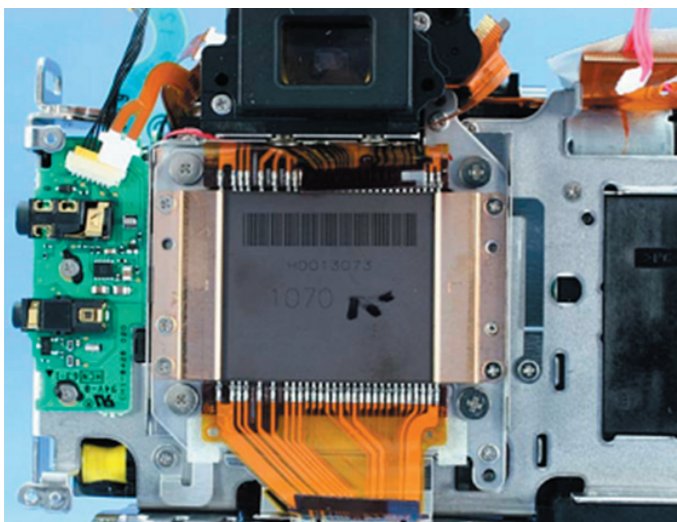
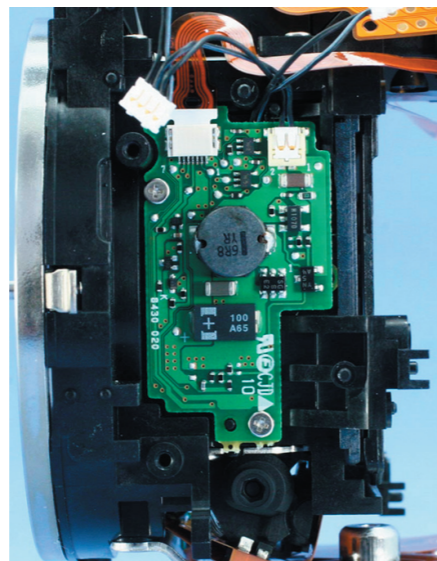
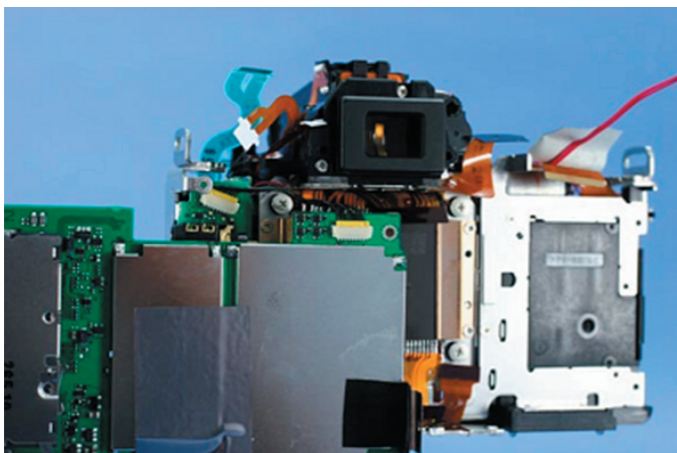
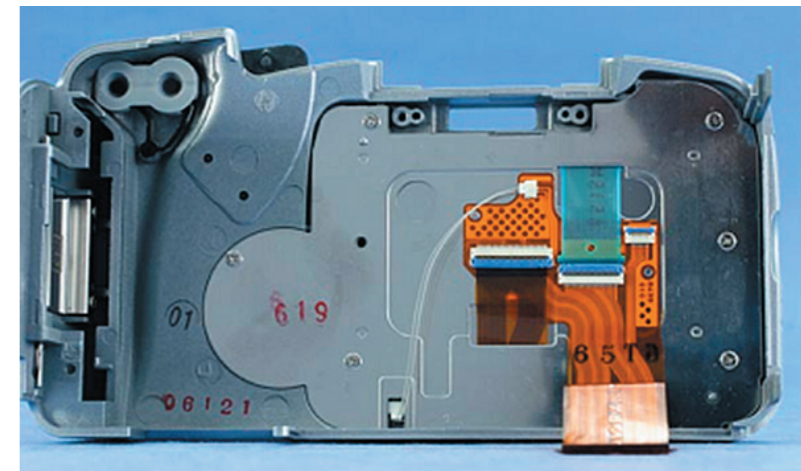
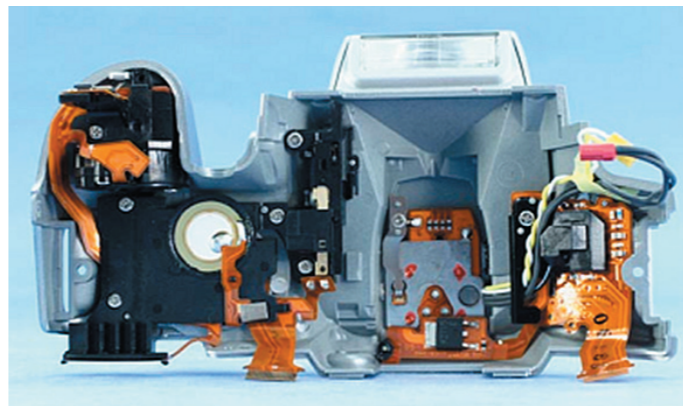
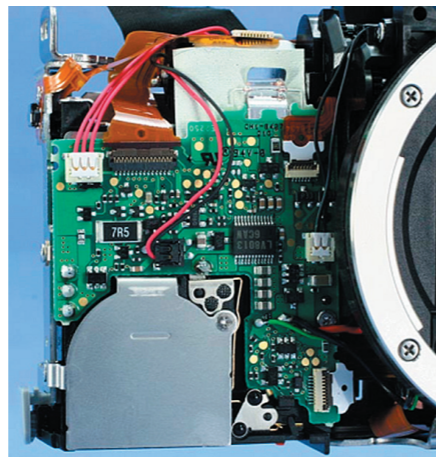
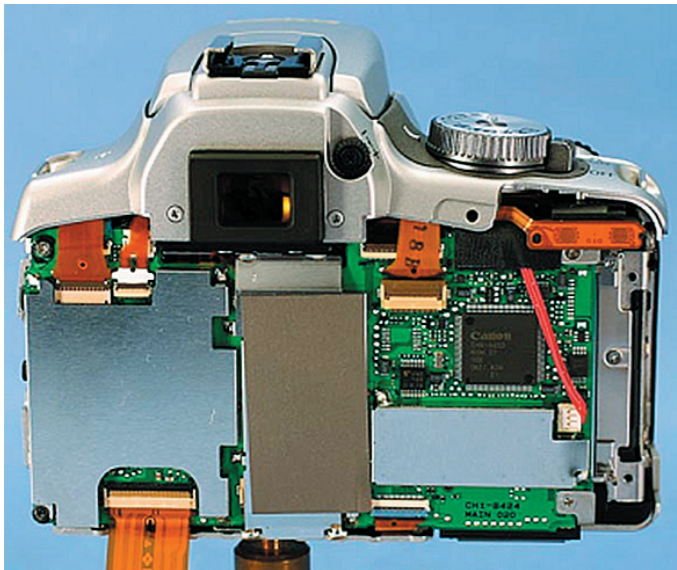

EOS D REBEL XTI / EOS 400D D SI POSITION CHECK CHART

