

Speedball Manual

A guide to constructing the
Speedball Camille Cascode Constant Current Source upgrade for the Crack Output
Transformer-Less tube headphone amplifier kit
Revised February 3, 2014

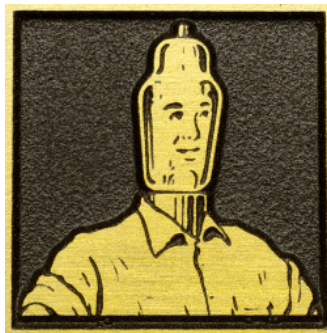

Copyright 2010, Bottlehead Corporation

TABLE OF CONTENTS

DISCLAIMER OF LIABILITY AND SAFETY NOTES	3
ACKNOWLEDGEMENTS	6
BRIEF CIRCUIT THEORY	6
AMPLIFIER SCHEMATIC	7
ASSEMBLY	
TOOLS AND ADDITIONAL MATERIALS YOU WILL NEED	8
PARTS CHECK LIST	9
PART ONE - BUILDING THE PC BOARDS	10
Large PC board	10
PC board soldering lesson	13
TIP-50 transistor heat sink mounting	15
Small PC boards	17
PART TWO—DEMOLITION AND INSTALLATION	18
Demolition	18
Installation	19
COMPLETED AMPLIFIER	27
VOLTAGE CHECK	28
BASIC TROUBLESHOOTING	30
GUARANTEE	33

HEY! You gotta read this first!

This kit contains parts which operate at high, ***potentially deadly***, voltages. In constructing, operating, and modifying this kit you agree to assume liability for any damage or injury resulting from exposing yourself or others to this high voltage, high temperature hazard. This kit contains only a partial enclosure and thus has not been designed to be shockproof or thermally isolated. The builder must have, or must acquire the knowledge to construct an enclosure which properly isolates this high voltage and high temperature from anyone coming in contact with the kit if deemed necessary. PLEASE NOTE! If you do not feel that you possess the skills, knowledge, or common sense necessary to safely construct and operate this electronic kit, ***do not attempt its construction!*** You may return the unused kit within 14 days of receipt for a refund of the purchase price, less shipping and handling, if you decide that you cannot safely execute its construction.

DO NOT:

- leave the kit operating in the presence of unattended children. Along with the shock hazard, there is also a potential for serious burns from touching hot vacuum tubes.***
- leave out the fuses, power switches or power supply bleeder resistors***
- Never assume that the shock or high temperature hazards are neutralized, even when the unit is unplugged!***

Safety and the Bottlehead

As more and more audiophiles come to the long forgotten conclusion that building your own tube gear is the best way to sonic heaven, the issue of safety around high voltages becomes terribly important. With the near demise of commercial tube audio gear in the late 60's, and the similar decline of kit building in the late 70's, safe test and construction techniques have been well nigh forgotten by most audiophiles who were there 'way back when' and information on the topic of dealing safely with the kind of high voltages present in the current crop of kit and DIY tube designs seems to be covered lightly if at all.

The basics

Tube audio gear tends to operate at much higher voltages than the current day solid state audio equipment. While a high power solid state amp might draw amps like an arc welder, it usually runs at 75V DC or less. Not to say that these kinds of voltages and currents can't hurt you, but a typical tube circuit may operate at anywhere from 120VDC to as high as an 'electrifying' 1500VDC or even higher! While these voltages are intimidating (in fact many experienced tube DIYers limit their construction to circuits running at 500V or less), that high voltage is only half of the safety issue.

Is high voltage dangerous in and of itself?

Spend some time around a small town TV repairman and eventually you will see him check the HV supply of a old style picture tube by touching the high voltage lead from the voltage tripler with his bare finger. A small snap will ensue, his hand will fly back, and he'll say, "Yup, it's working". Is there a destructive streak in TV repairmen? That supply is probably at a potential of 5kV to 10 kV!

Nope, the repairman knows that there is virtually no current available from the supply, so while the high voltage may give him a slight 'zap', the supply can't push enough electrons through our intrepid TV guy to really do any short term damage.

NOTE: we are not condoning this practice, in fact there are studies that show repeated microshocks may indeed be detrimental to the nervous system - we're just trying to explain by example!

Current kills

But- let's consider a single ended 300B amp. Now we have a power supply that can supply far less potential than that TV high voltage supply, maybe only 450 volts, but it may be able to push out 160 mA of current (if it's a stereo amp). Before you grab a bare terminal in that supply while in your bare feet on the basement floor, you might want to make sure your life insurance policy covers acts of incredible stupidity.

It is interesting to note that in the days of tube powered test gear Tektronix corporation use to put a warning inside its oscilloscopes reminding the technician that the lowly 400 volt supply, which supplied as many as thirty or forty current hogging tubes, was far more dangerous than the intimidating looking tube rectified voltage tripler circuit.

So yes, those 900V+ 211 and 845 and circuits demand a lot of respect from the builder, but watch those 250V 2A3 amps too!

OK, so how to stay safe?

First some basics. Always wear shoes when working with electronic gear, preferably rubber soled, and particularly when standing on concrete floors. This is because the high potential source will want to find it's way to ground potential. If your body supplies a path to ground, that's where the juice will go, homes. Right through you! The rubber soles will insulate you from ground.

Another classic path to electrocution is from one hand to the other. If you grab the chassis of an amp or preamp with one hand, and touch a live terminal with the other, guess where the current will flow. Right through you! The oldtimers figured out a good way to avoid absent mindedly performing this shocking display - train yourself to always keep one hand in your pocket when reaching into live gear.

A heartstopper

The reason these paths are two of the most critical is because they cross through one of the more electrically sensitive organs in your body - the heart. Because the heart is slightly to the left side of the chest cavity, it is actually slightly safer to use your right hand than your left hand when reaching into or touching a probe to live circuits, as the path to ground through your feet does not pass quite so directly through your heart as current passing through the left hand would.

I'm safe, you're safe, now what?

Make sure you stay away from mains wiring! Remember that the power cord is live even if the equipment is switched off. And don't forget those mains usually supply 15-20A before the circuit breaker will trip. If you don't need a piece of gear plugged into the wall to test it (say you need to check a resistance), don't leave it plugged in! If it must be plugged in, consider use of an isolation transformer between the wall socket and the equipment to be tested, which will create a current limit on what the AC mains can supply.

GFI's

A ground fault interrupter is a must have in garage and basement shops with concrete floors, and anywhere else where the floor could get wet. Install them in your work area if they are not already installed.

A few tips

I use test leads on my meters that have optional alligator clips that can be slipped over the pointed probe tip. If I can avoid holding a probe in my hand when checking a live circuit I do, and the clips make this possible. The alligator clip is particularly useful for the grounded probe. Even if you must measure several points, attaching the negative probe to the ground plane or buss lets you concentrate on the hot test points, which can save not only your precious hide, but help you to keep from shorting the test point to ground from an errant slip, which is the number one way to blow underchassis components.

Never, I repeat, NEVER lean over live equipment or put probes in where you can't see them!

I won't go into the details of a story our friend Scott Grammer told us about an inexperienced tech who didn't heed this warning when working on a microwave oven. Suffice it to say they cut his body away from the still smoldering equipment an hour later.

Also it is a very good practice to only work on high voltage equipment when someone else is present, in case you are accidentally hurt. This can be tough for some of us - all the more reason to practice meticulous safety habits.

Wear safety glasses. I always wore safety glasses when using power tools, but never when soldering. A hot blob of solder in the eye, from an uncooperative desoldered joint, cured me of that right quick.

Don't forget that capacitors can still pack a wallop, even if the equipment is switched off. Practice the habit of bleeding the charge from power supply filter capacitors using a 10Kohm or so resistor with a clip lead attached to each end. Attach one lead to the + terminal of the cap, the other to the - terminal, and leave it on for a few seconds. Better yet, permanently install 270Kohm or so bleeder resistors from + to - across each filter capacitor like we have in our kits. They won't affect performance, but will save you the hassle of manually bleeding the filter caps.

Well, there's some very basic safety techniques. Tube gear is fabulous, but like all great things, it commands a high level of respect.

Doc B.

ACKNOWLEDGEMENTS

Thanks to Paul “PB” Birkeland for working up the circuit design and layout scheme used in this kit. Thanks to Paul Joppa for the design of the Bottlehead PT-3 power transformer used in this kit. Thanks to John “Buddha” Camille for the Camille Cascode Constant Current Source and for all his mentoring in proper grounding techniques thru the years. We miss you, boss. Thanks also to Queen Eileen Schmale for putting up with yet another of Dr. Bottlehead's cockamamie schemes.

What the Speedball ugrade kit is about

The Speedball kit is an application of the Camille Cascode Constant Current Sources that have been used throughout the Bottlehead product line, to the Crack Output Transformer-Less (OTL) headphone amplifier. It is employed to reduce distortion and further reduce the already exceptionally low noise floor by increasing power supply ripple rejection (PSRR). The audible result is a sense of better dynamics, tighter bass, and more defined imaging.

Brief circuit theory

A Camille Cascode Constant Current Source is applied to each triode—both halves of the 12AU7 voltage amplifiers and both halves of the 6080 cathode followers.

By loading a triode voltage amplifier with a high impedance, such as an active current source, it operates in a more linear region and produces less distortion. A second advantage, not as widely appreciated, is that the current source provides a great deal of isolation from the power supply. A good current source will provide a high impedance over a wide range of frequencies including radio frequency interference. It is otherwise extremely difficult to stop RFI that is carried on the power line, because power supply chokes have a leakage capacitance and the large capacitors used will also have some inductance at high frequencies. Isolation from the power supply also removes the power supply capacitors from the signal current loop.

Maximum output is about 10V rms (28V pk-pk) before clipping into a 300 ohm load. Gain is about 15 dB into a 300 ohm load. Output impedance is about 120 ohms - recommended headphone load is 100 ohms or greater. Frequency response is +/- 0.5 dB from 10Hz to 50kHz into a 300 ohm load. Phase is inverted.

Bottlehead Crack Output Transformer-Less Headphone Amplifier with Speedball Constant Current Source Upgrade

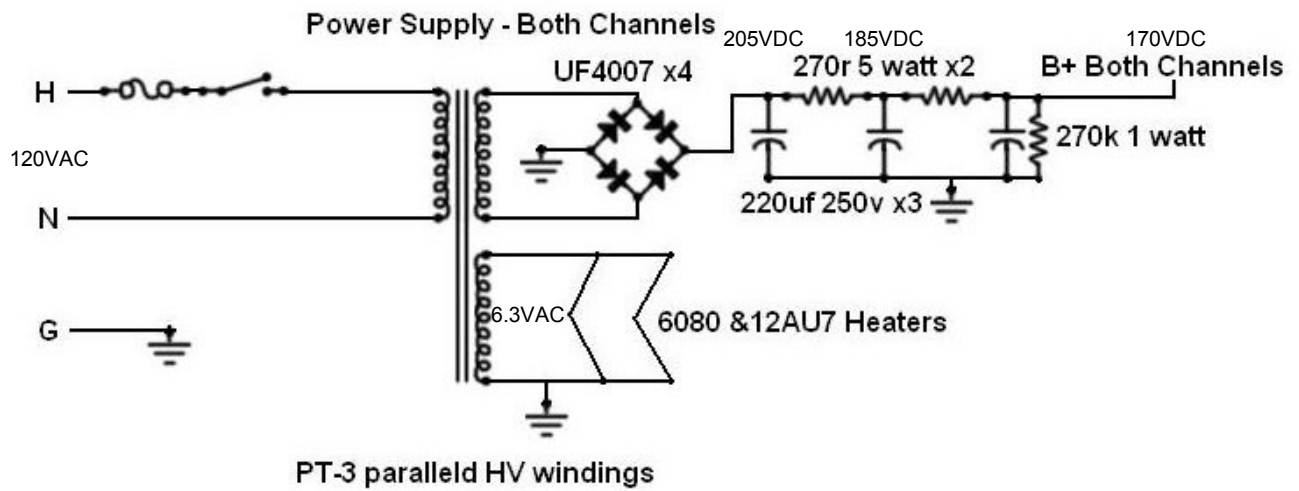
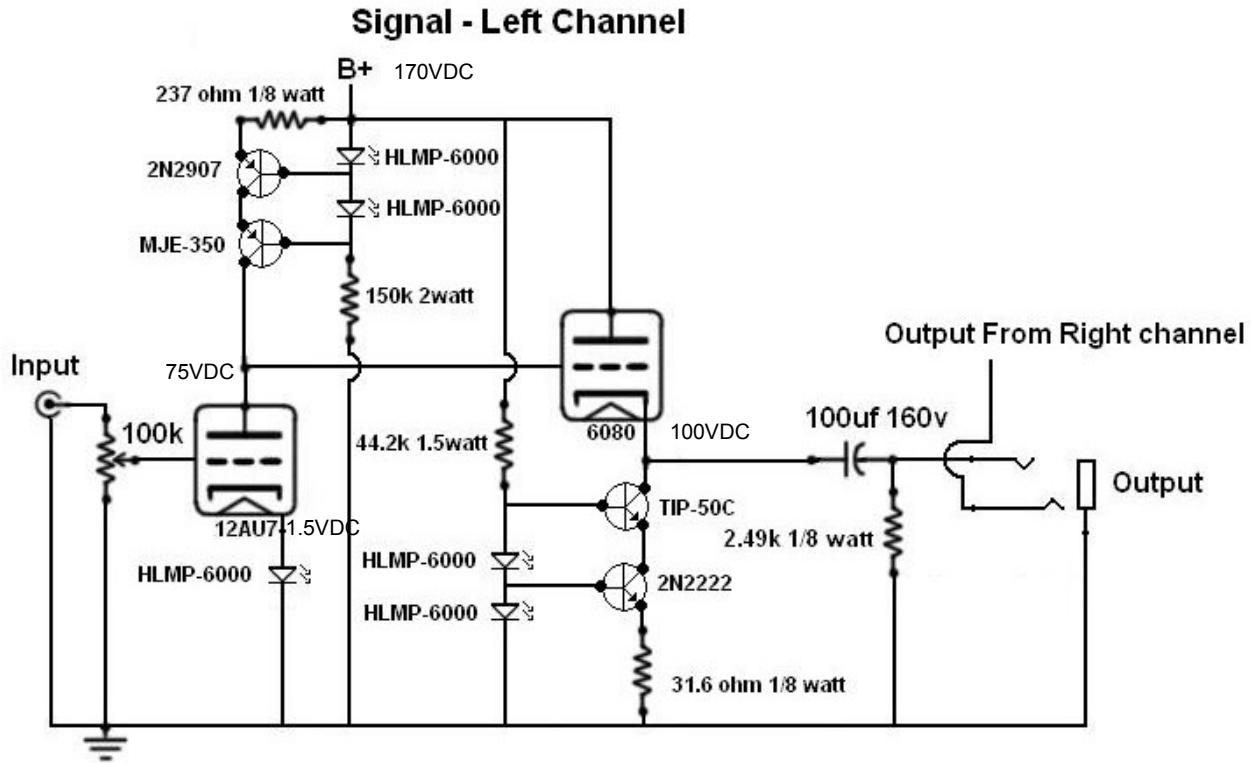

Tools and additional materials you will need:

- eye protection
- slotted tip screwdriver
- needlenose pliers
- wire cutters
- wire stripper for 12ga. and smaller wire
- soldering iron, 40W is fine. An inexpensive solder station is much, much better
- volt-ohm meter - we suggest a 'pocket DMM' - use this for sorting out hard to read resistors
- a good light source
- Sharpie or other marking pen for terminal ID
- a soft towel or placemat to rest the amps on while working on the underside—the sticky bubble wrap supplied with your kit can also work well as a cushion for your project.

other tools that are nice to have:

- magnifying glass for parts identification
- desoldering tool or desoldering braid
- A set of small sockets and a socket wrench for tightening the mounting hardware
- A “third hand” tool can be useful for situations where you need support the parts you are working on while keeping both hands free to solder

Solder - we recommend standard 60/40 or 63/37 tin/lead solder as the easiest to work with. 2% silver solder is OK, but stay away from 4% silver solder. It does not flow well. If you are using an adjustable solder station you will want to set the temperature to about 650-700 degrees.

Speedball Kit Parts List

use your DMM on the “ohms” setting as an easy way to verify the resistor values

- () 1-Speedball PC board
- () 2—small PC boards

- () 2 ft. red Teflon wire
- () 2 ft. black Teflon wire

- () 6- 4-40x1/4” screw
- () 2- #6 round lockwasher
- () 4 - #4 nylon standoff
- () 2—2”x1-3/8”x1/2” heat sink
- () 2- transistor heat sink mounting kit

- () 8—HLMP-6000 red LED
- () 2—TIP-50 transistor
- () 2—MJE350 transistor
- () 2—2N2222A transistor
- () 2—2N2907A transistor

- () 4- 22.1k 3/4W metal film resistor (red, red, brown, red, brown)
- () 2—31.6 ohm 1/8W metal film resistor (orange, violet, blue, gold, brown)
- () 2—237 ohm metal film resistors (red, orange, violet, black brown)
- () 2—150K 2W metal film resistor (brown, green, yellow, gold)

- () 1 - Speedball manual CDROM

Some of the parts included in your kit may vary slightly from the descriptions here. Occasionally parts can be mis-packed, so call us at 360-697-1936 if you have problems finding all the correct parts in your kit.

Assembly, Part One - Building up the PC boards

Check each step off as you complete it

() First, check the parts supplied in your kit against the check list on the preceding page. Call us at 360-697-1936, M-F 9-5 PT, if you are missing any components listed on the checklist.

Large PC Board:

() Orient the PC board with the word "top" facing up.

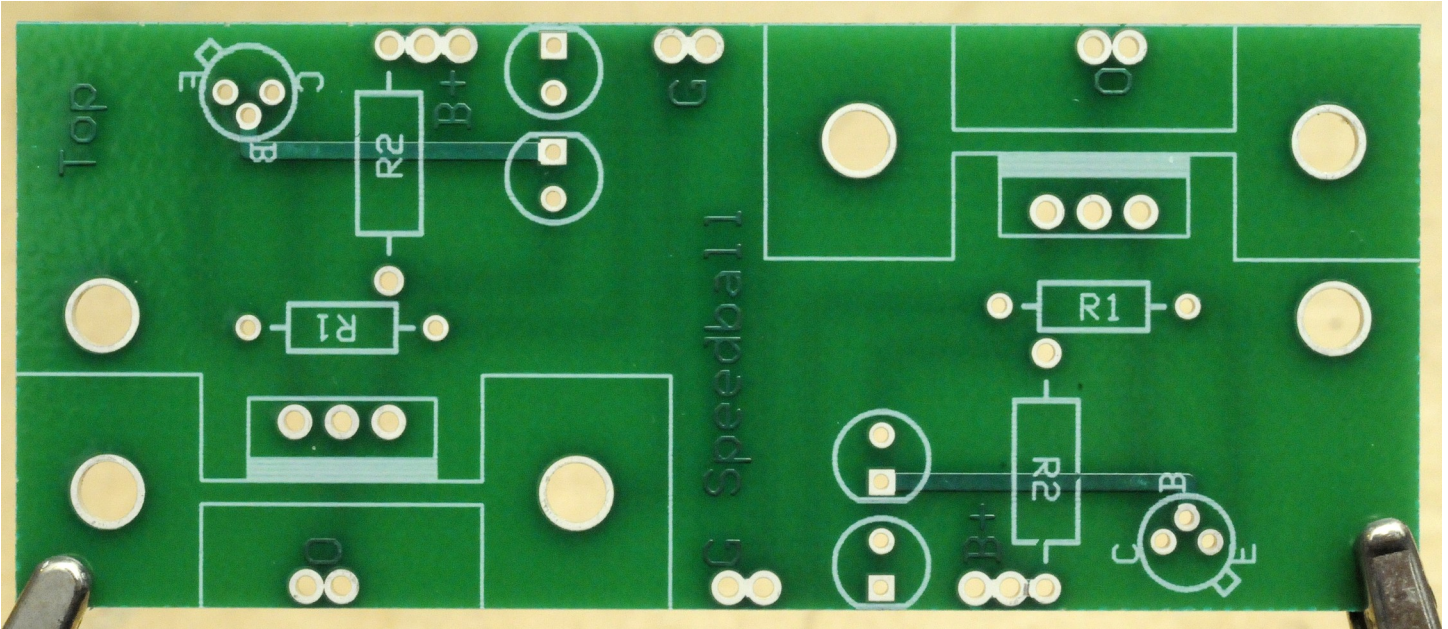

() Install the four HLMP-6000 red LED's with the banded ends in the square solder pads and facing the outside edges of the PC board.

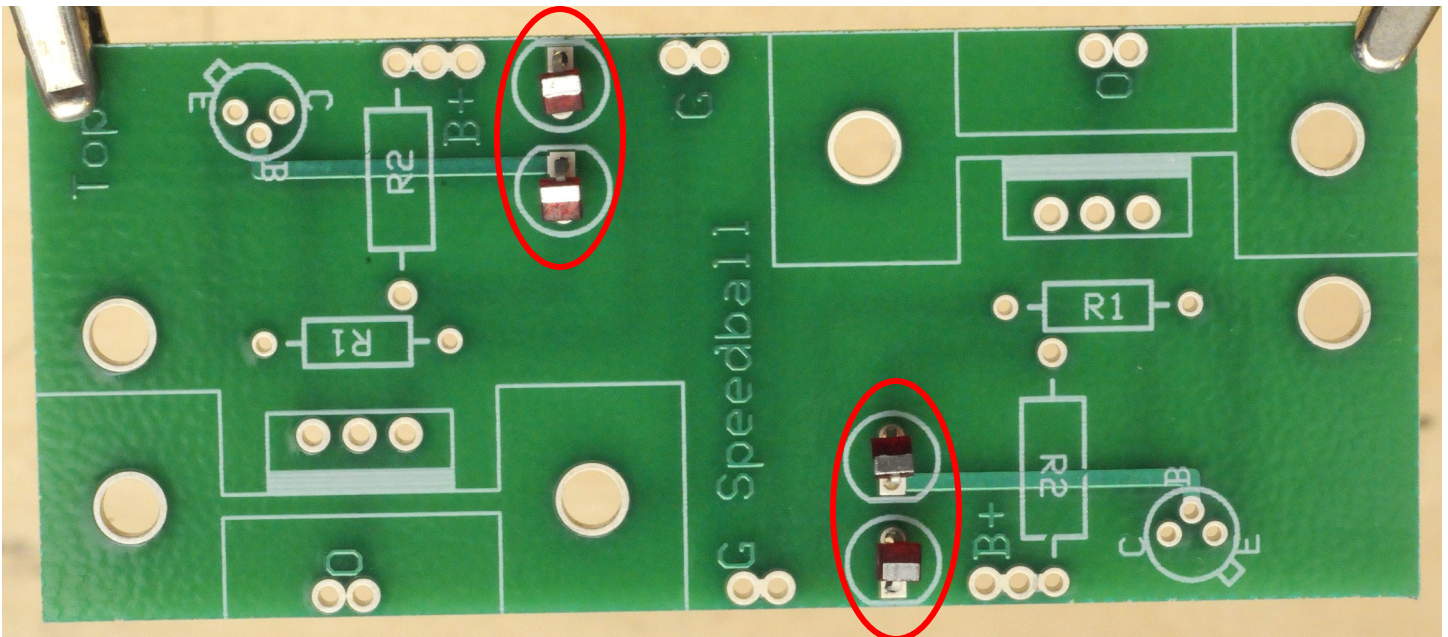

Bending the leads of the various components parallel to the back of the PC board after insertion will help them stay in place.

() Install the 31.6 ohm resistors in the R1 positions as shown.

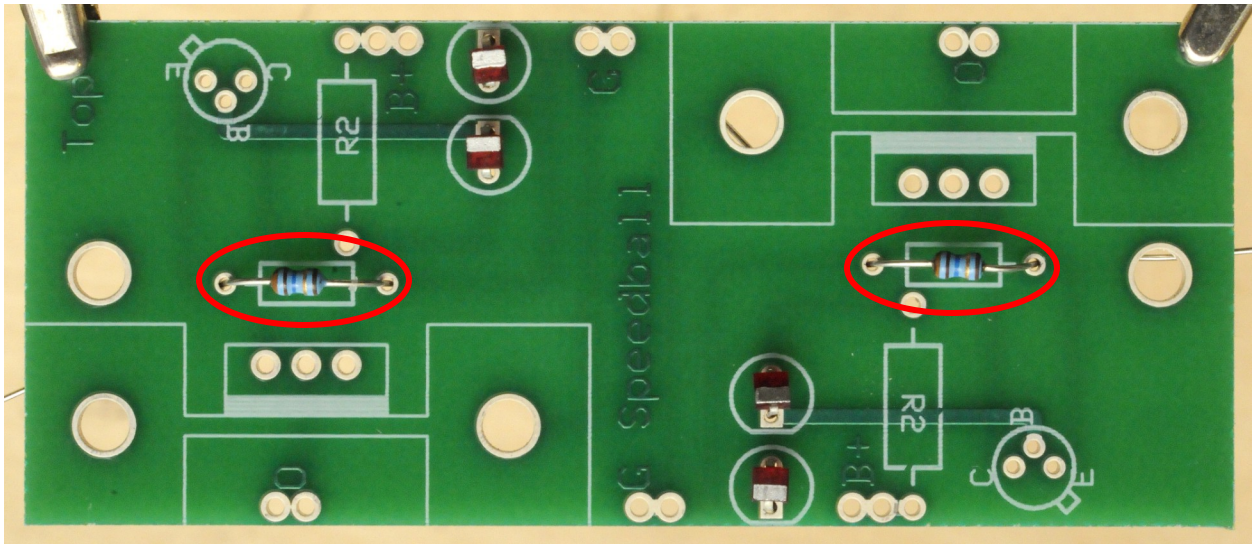

() Twist the leads of two 22.1k $\frac{3}{4}$ watt resistors together.

() Solder the twisted leads and trim to $\frac{1}{4}$ ".

Repeat for the other pair of 22.1k $\frac{3}{4}$ watt resistors.



Install them in the R2 positions on the board as shown

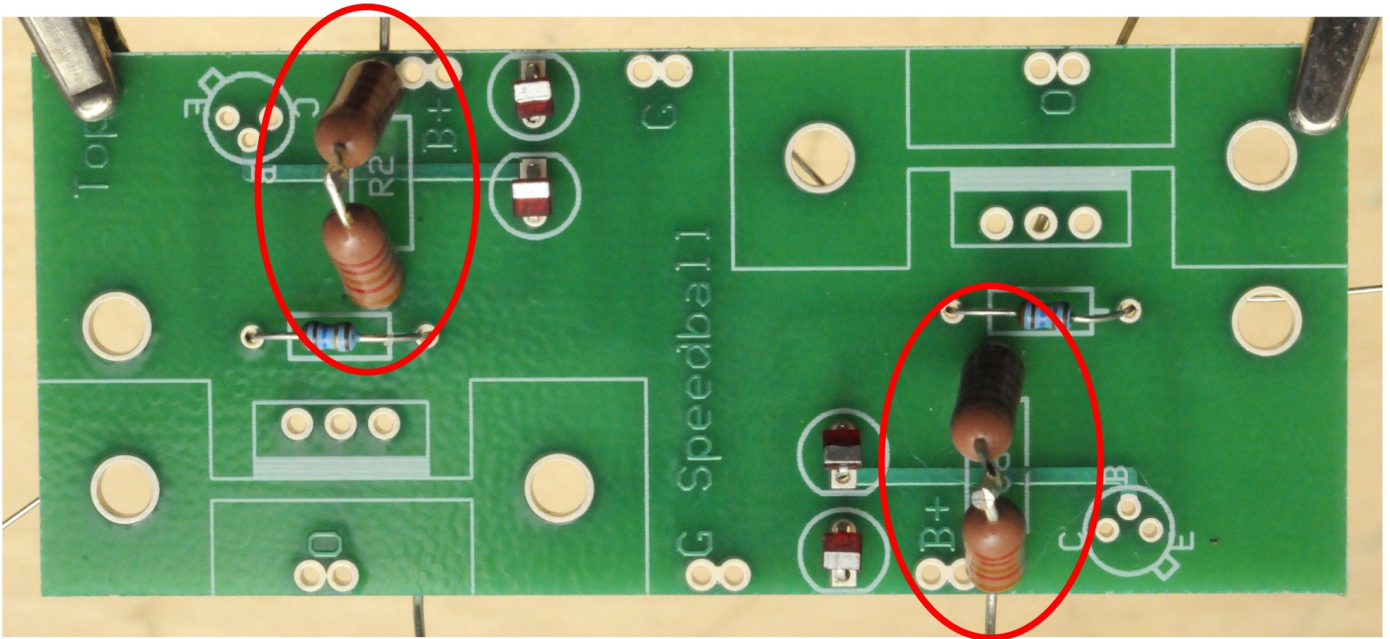

Install two 2N2222A transistors as shown. Note that the tab on the edge of the can lines up with the outline of the tab on the PC board

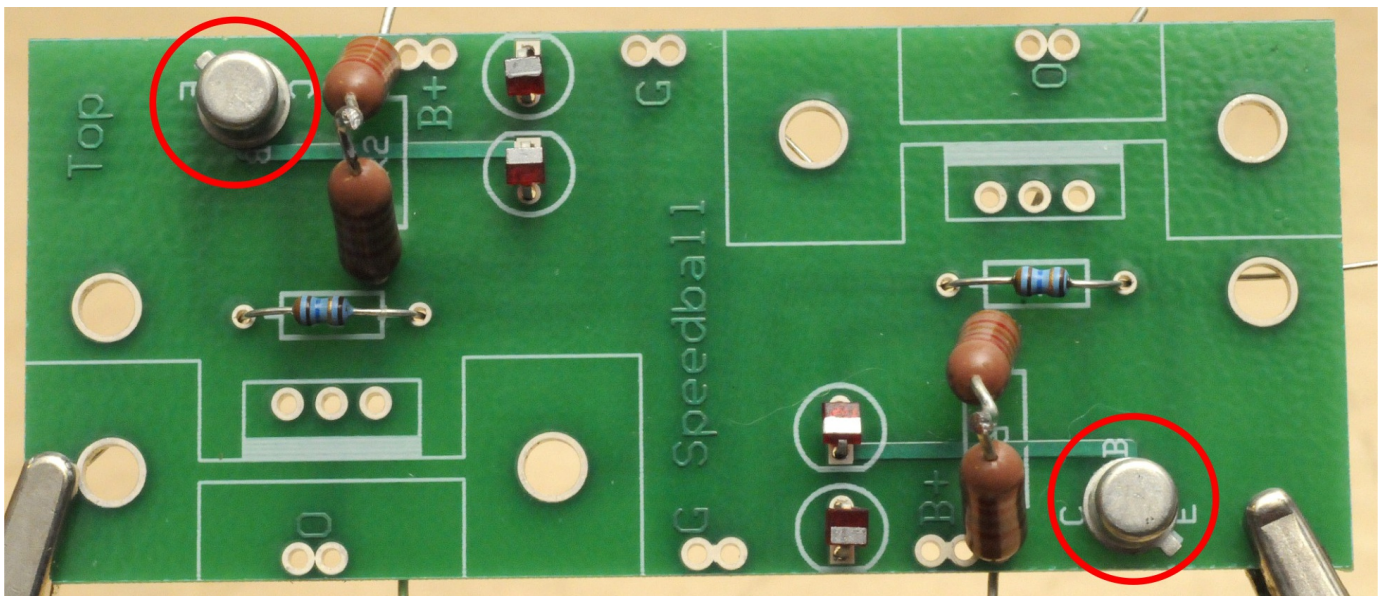

Leave some space between the metal body of the transistor and the PC board

MAKE 100% SURE THAT YOU INSTALLED THE 2N2222A TRANSISTORS.

You should still have two 2N2907A transistors left to be installed. Selecting the wrong transistor causes a large group of kits to not function, so **CHECK AGAIN.**

The PC board should now look like this from the backside.

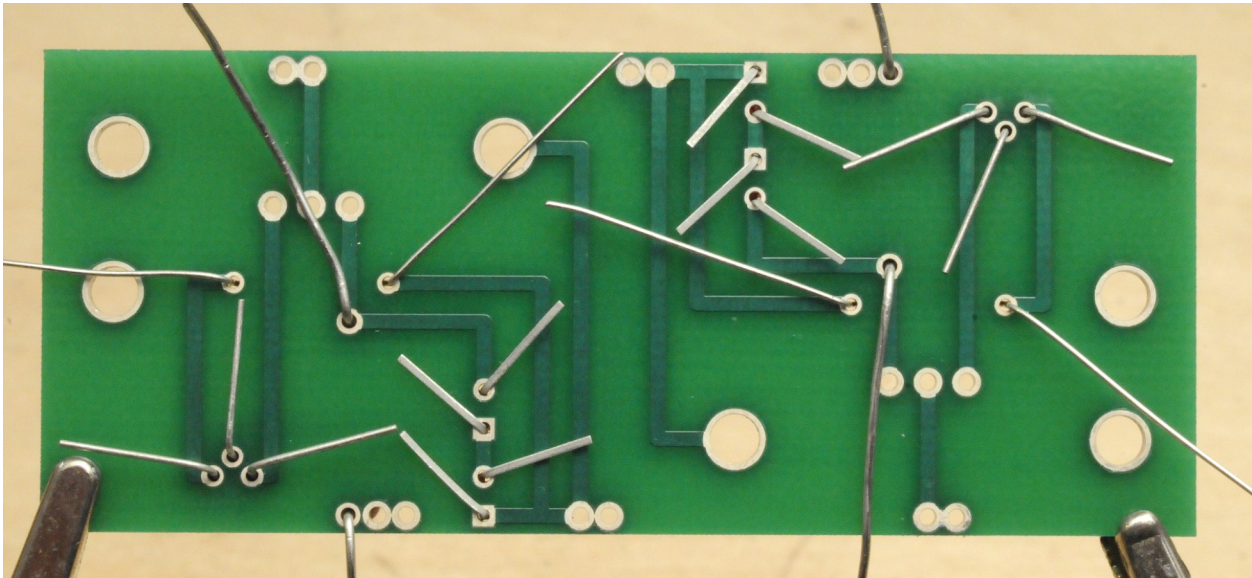

OK, time to fire up your soldering iron!

WHOA! PC Board Soldering lesson!

Most of all, remember that the soldering iron is a hot item! The tip temperature can approach 800 degrees, and won't feel too good if you absent mindedly touch it! (Think of a steak hitting the hot grill of your BBQ...)

Here's the scoop on soldering PC boards:

- A “third hand” tool is very useful for this, supporting the PC board while you hold the iron in one hand and the solder in the other.
- Solder on the back, or bottom side of the PC board, where the component leads stick out. Apply the tip of the iron to contact *both* the solder pad and the lead attached, and let it rest against the joint long enough to heat both thoroughly.
- Flow enough solder onto the joint to fill the joint between the pad and the lead threaded through it. Look for a concave fillet of solder at each junction rather than a convex blob of solder.
- Be sure to touch the solder to the hot joint, not only to the tip of the iron.
- Remove the iron and let the joint cool unassisted (don't blow on it!). A joint which cools too quickly or moves will become “cold”, it will crystallize and cool to a dull finish. A cold joint will not function structurally, nor will it conduct properly. Reheat any cold joints, applying a small additional amount of solder, and make sure that it cools to the proper shiny finish.

- Keep the tip of the soldering iron clean. A slightly damp sponge is the tip cleaning tool of choice.
- If you have a temperature adjustable soldering station, try setting the tip temperature to about 650 to 700 degrees for PC board work.
- Watch for “solder bridges”, places where the solder has bridged across a gap, joining two pads that should not be joined. Remove any solder bridges with solder braid, a braided copper tape that absorbs molten solder and wicks it away from the solder joint. A spring or suction type desoldering tool may also be used.

If you have middle aged eyes, don't be proud! For those of us with presbyopia, reading glasses can make a seemingly tough job quite simple. Use them in place of your safety glasses. **You are wearing safety glasses when you solder, right?**

() Solder **every** pad that has a lead in it. When finished, trim all the excess leads flush to the board. Inspect your solder joints closely with a magnifying glass. 99% of the few kits that are sent to us each year for warrantee work have a missed solder joint on a PC board—hardly worth shipping a kit across country for that!

Your PC board should look like this on the underside when you are finished.

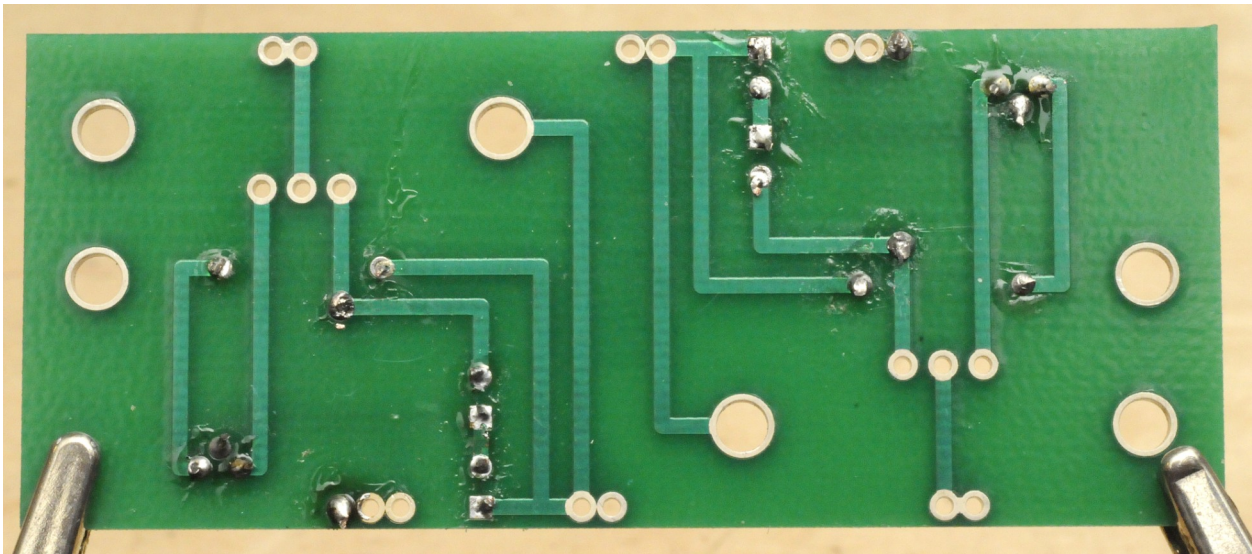

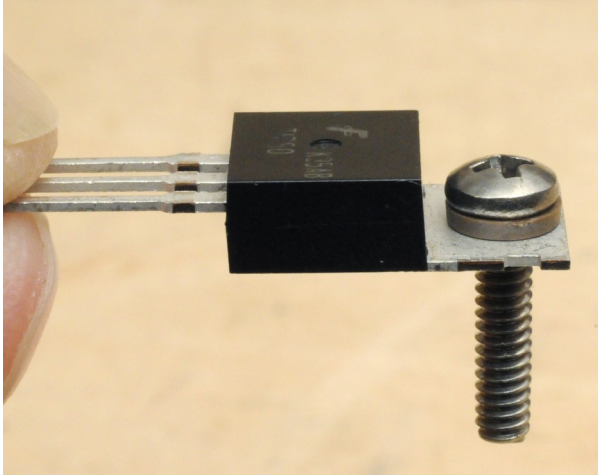

() Unpack one transistor mounting kit. Slip the fibre washer onto the bolt provided, then slide the bolt through one TIP-50 transistor.

() Next slide the thermal pad over the bolt.

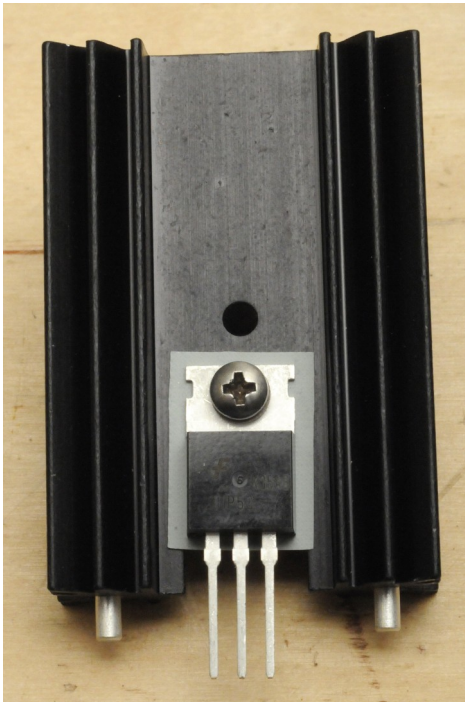
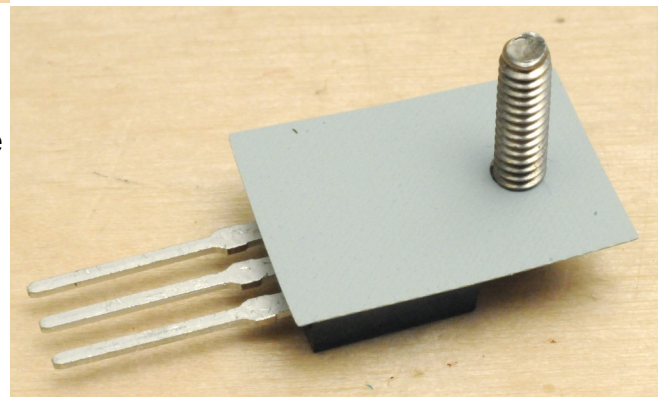

() then mount this assembly through the middle hole in the heatsink.

() Secure this assembly snugly with the flat washer, lock washer, and nut in that order.

() Repeat for the other transistor/heat sink.



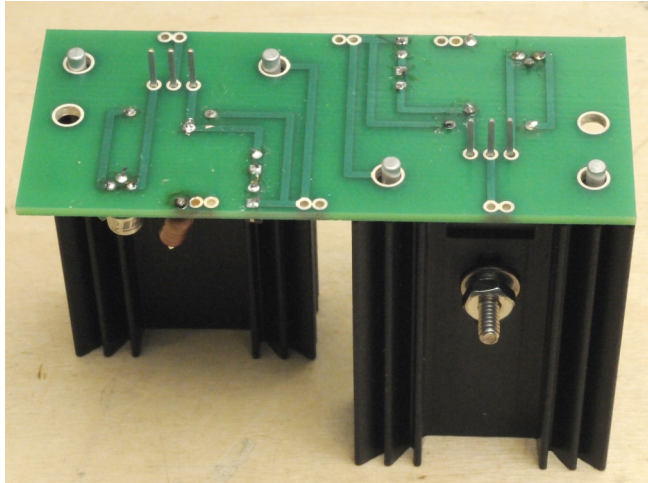

() Install both heatsink/transistor assemblies. This is easiest if you slip the heatsink/transistor assemblies onto the board from the top, then flip it over and rest it on the heatsinks themselves.

() Solder the three leads of each TIP-50 and also solder the two lugs of each heat sink to the PC board

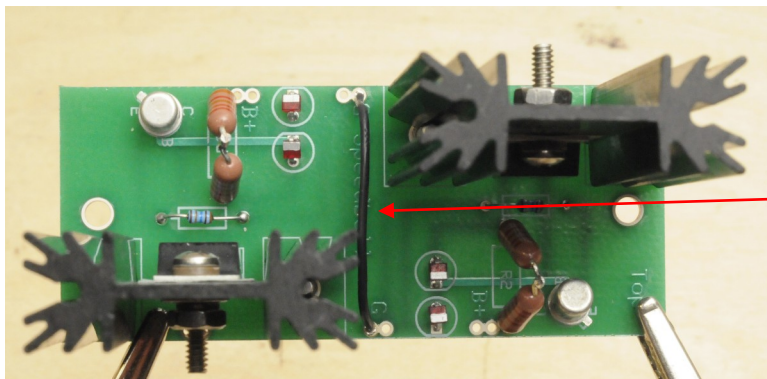
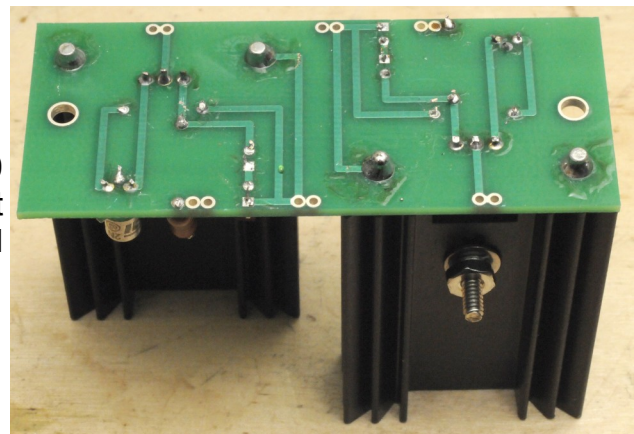

() Cut a 1 $\frac{3}{4}$ " piece of black wire. Strip both ends back $\frac{1}{4}$ ". Jumper between the two center holes that are labeled G on the top side and solder.

() Cut a 2 $\frac{1}{2}$ " piece of red wire. Strip both ends back $\frac{1}{4}$ ". Jumper between the two center holes labeled B+ and solder.

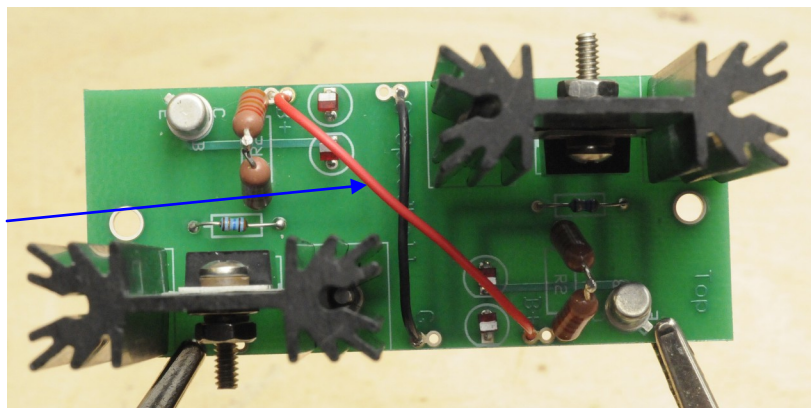

Small PC Boards:

You will build two identical boards. Some boards may have an "A" on them and some may have a "B". This does not matter, both boards are identical.

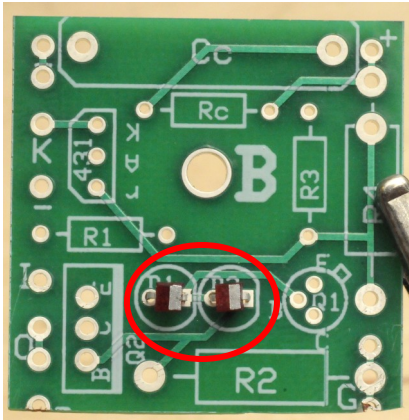

() Install an HLMP-6000 LED in the positions labeled D1 and D2 with the banded end toward the straight edge of the each LED pad.

() Install a 237 ohm resistor in the R1 position.

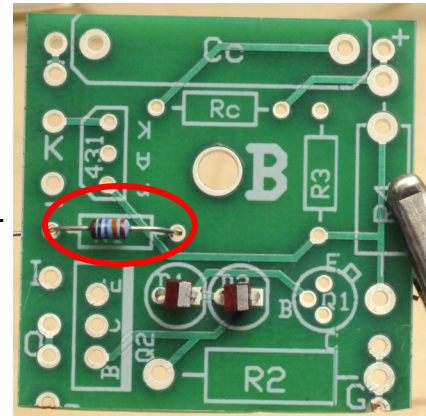

() Install a 150k resistor in the R2 position.

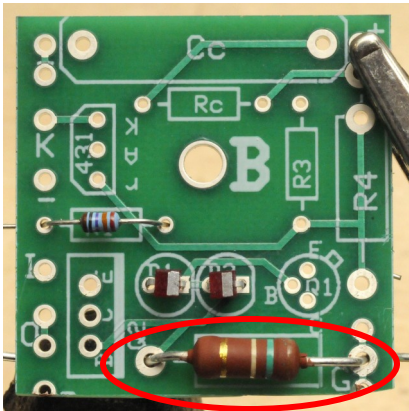

() Install a 2N2907 in the Q1 position as shown. Be sure there is a little bit of clearance between the metal transistor body and the PC board.

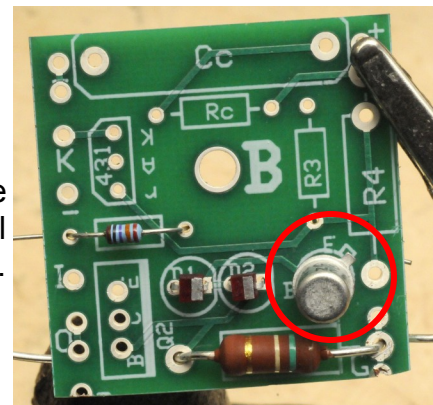

() Install an MJE350 in the Q2 position as shown, with the metallic face of the transistor facing the center of the PC board.

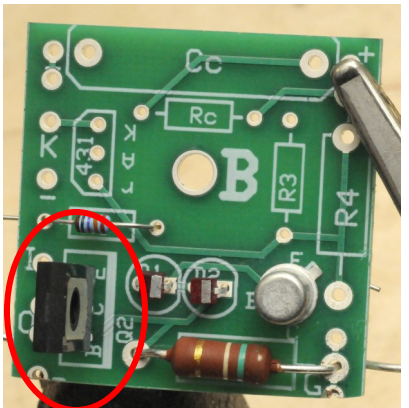

() Solder all connections and trim all leads.

Assembly, Part Two - Demolition and Installation

Demolition

Remove the 22.1k plate load resistors.

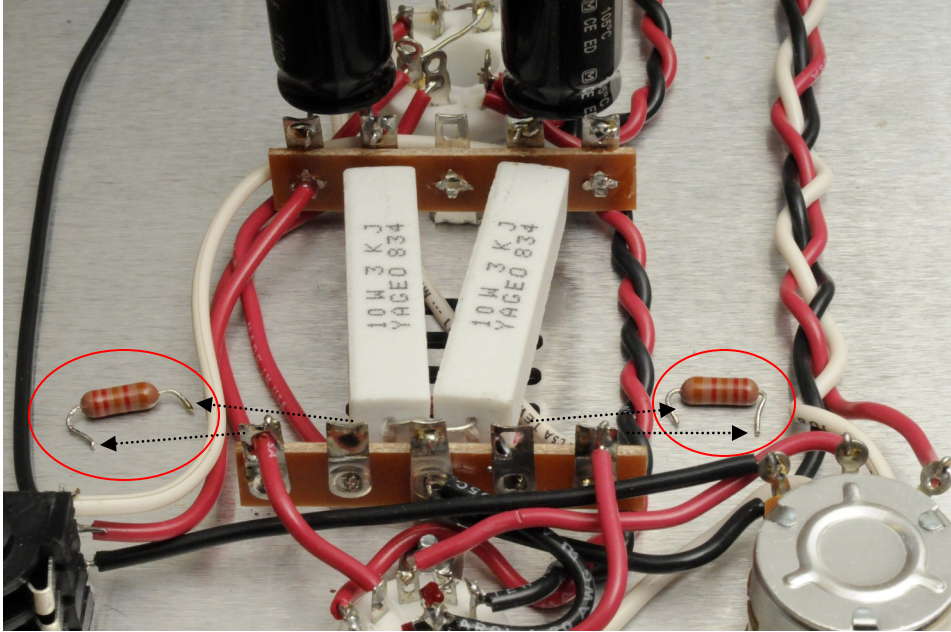

Remove the 3k cathode resistors.

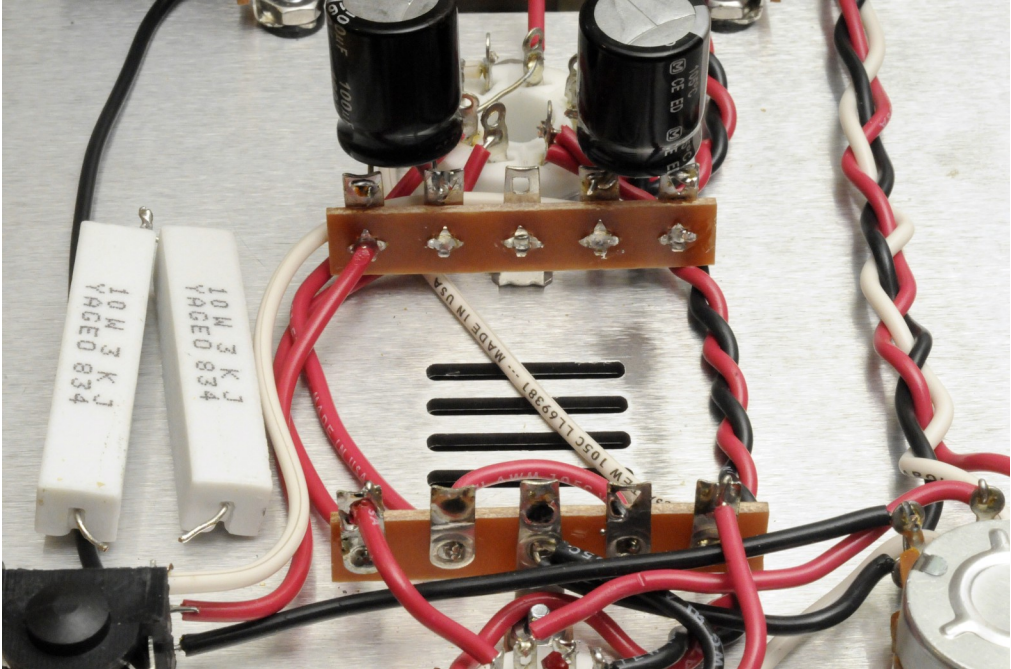

Installation

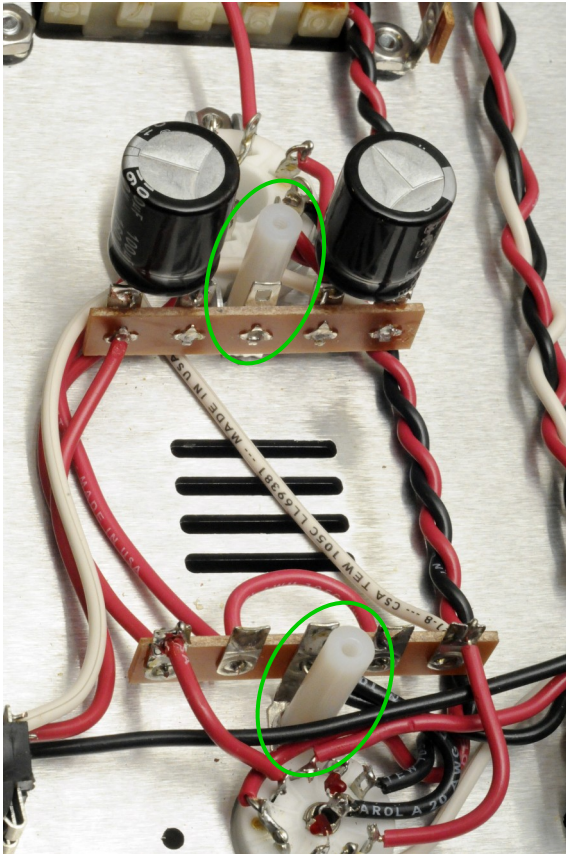

() Install two nylon standoffs, one on the top screw of the 9 pin socket, and one on the bottom screw of the octal socket. **Do not** remove the nuts before you do this.

() Slip one #4 x 1/4" screw through the left empty hole by the 9 pin socket. Slide a #6 lock washer over the threads, then tighten down another nylon standoff. Repeat for the right empty hole.

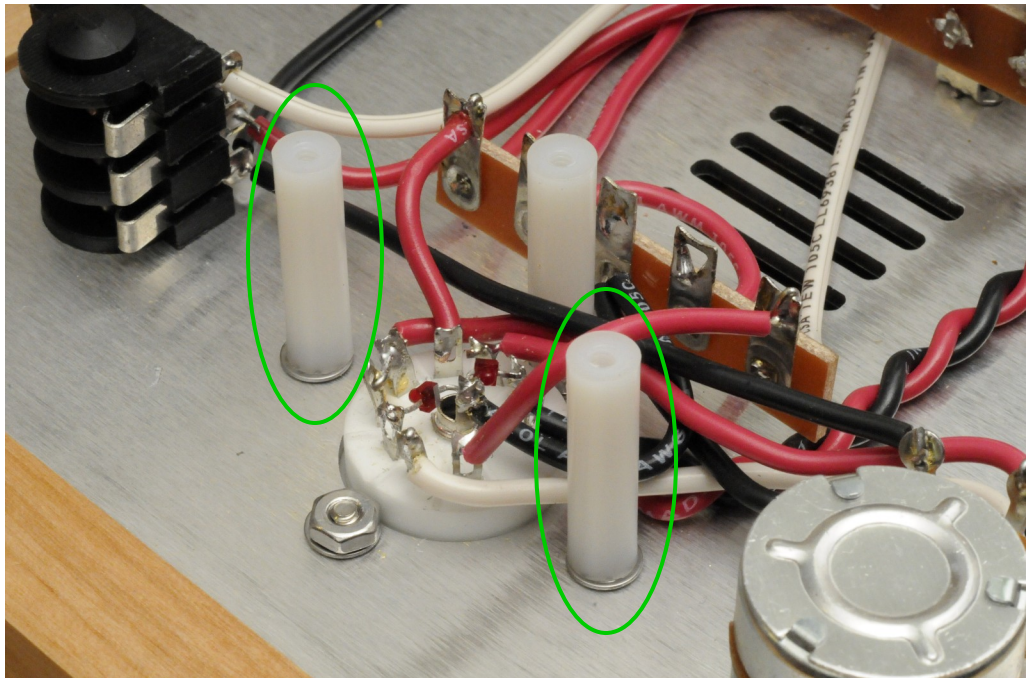

Cut a 2" piece of red wire and strip both ends ¼". Attach one end to 2U.
 Cut a 1½" piece of black wire and strip both ends ¼". Attach and solder one end to 7L.

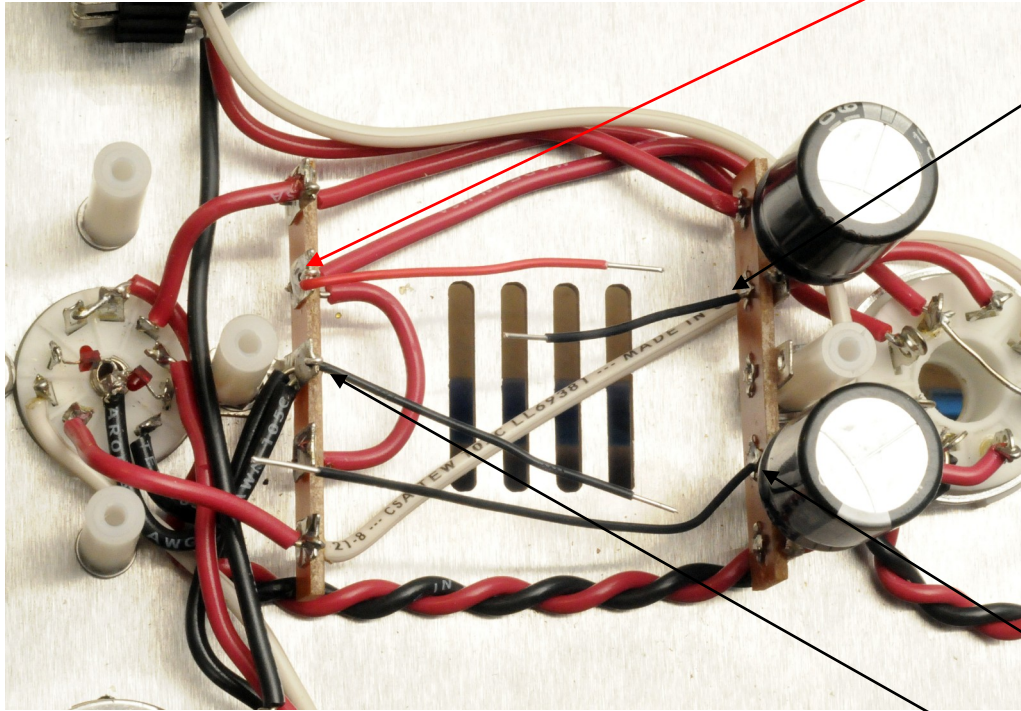

Cut a 3" piece of black wire and strip both ends ¼". Attach and solder one end to 9L.
 Cut a 2" piece of black wire and strip both ends ¼". Attach one end to 3U.

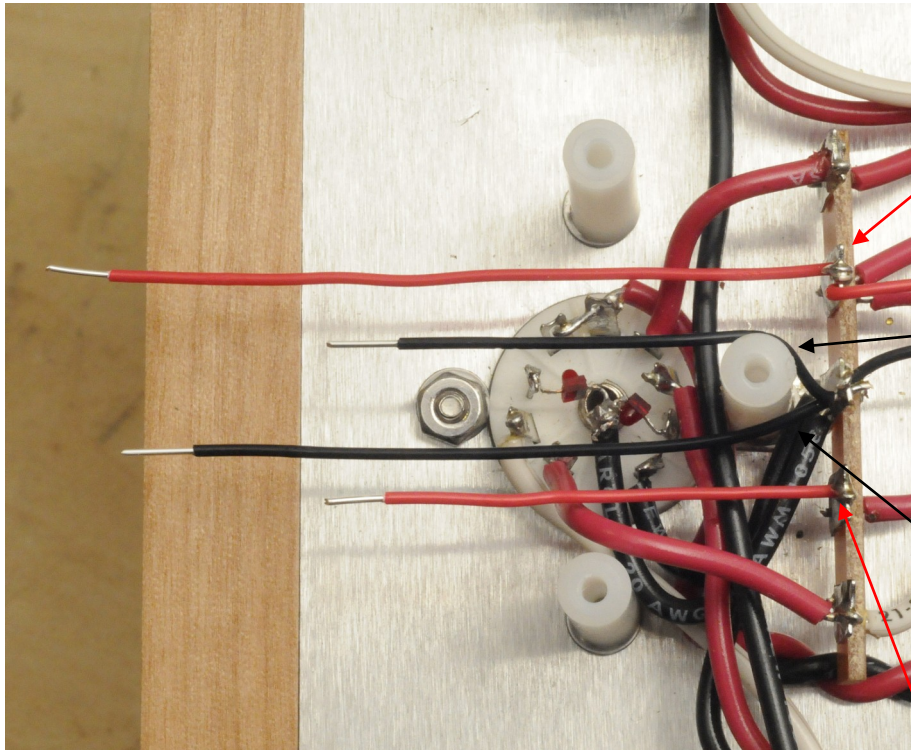

Cut a 3" piece of red wire and strip both ends ¼". Attach one end to 2U and solder 2U.
 Cut a 2" piece of black wire and strip both ends ¼". Attach one end to 3U.
 Cut a 2¾" piece of black wire and strip both ends ¼". Attach one end to 3U and solder 3U.
 Cut a 2" piece of red wire and strip both ends ¼". Attach one end to 4U and solder 4U.

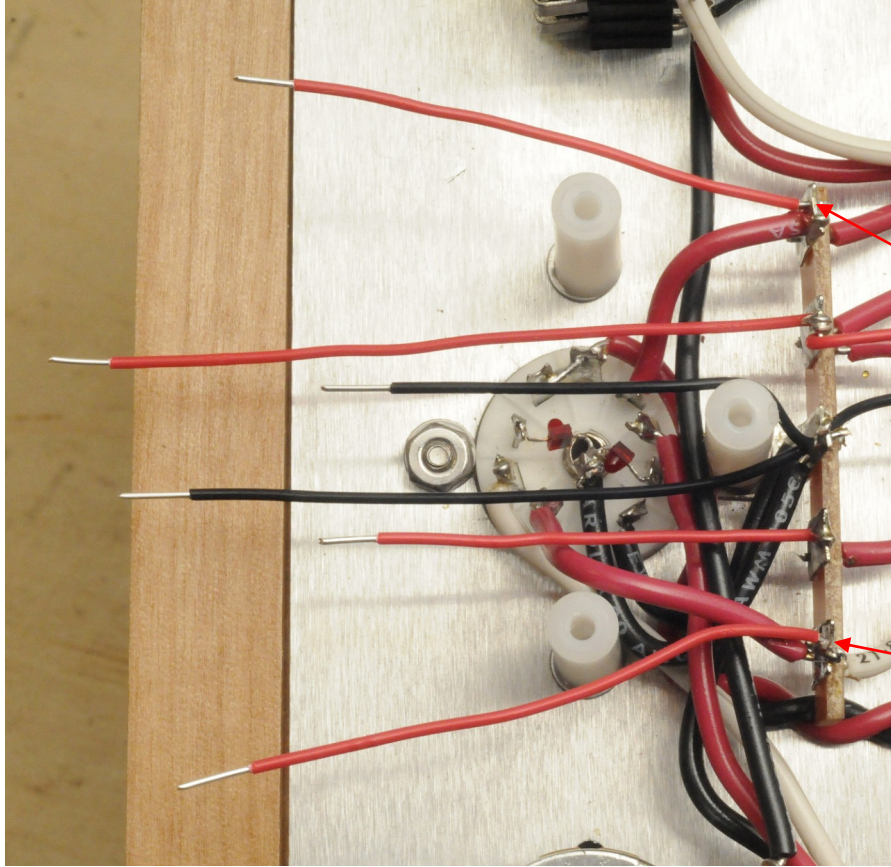

Cut a 2¼ " piece of red wire and strip both ends ¼". Attach and solder one end to 1U.

Cut a 2½" piece of red wire and strip both ends ¼". Attach and solder one end to 5U.

Mount the left side green board with a #4x¼" screw.

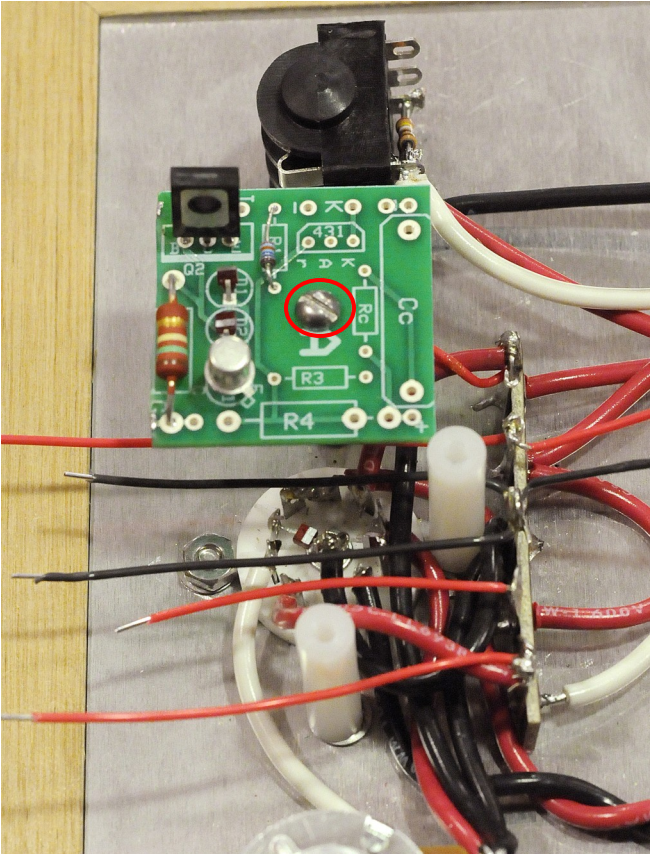

() Attach and solder the outermost left red wire (from 1U) to one of the two pads labeled O.

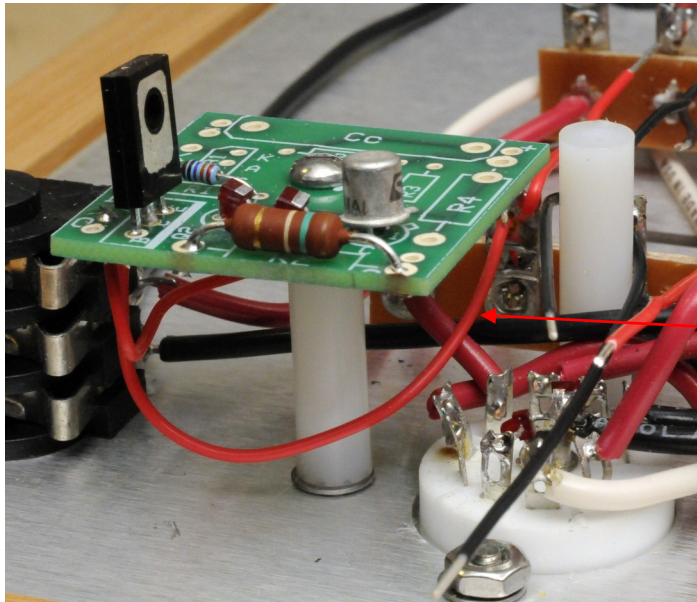
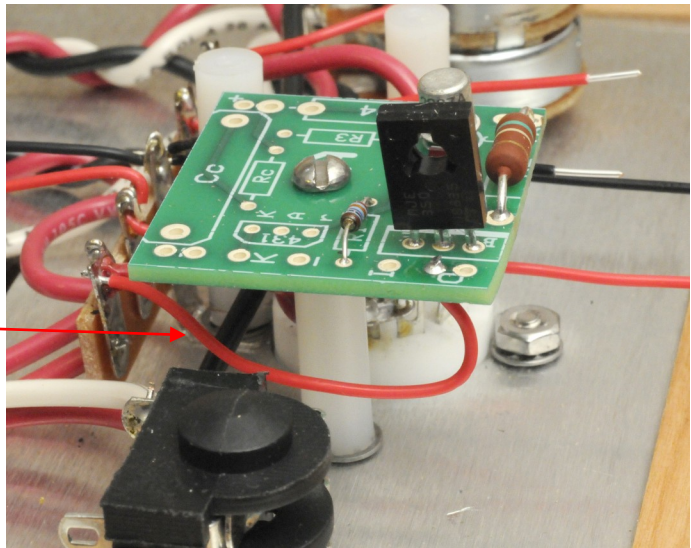

() Attach and solder the inner red wire (from 2U) to the I terminal.

() Attach and solder the left black wire (from 3U) to the G terminal.

Note: the "G" may not be visible on the board. The pad is next to the outboard end of the 150K ohm resistor.

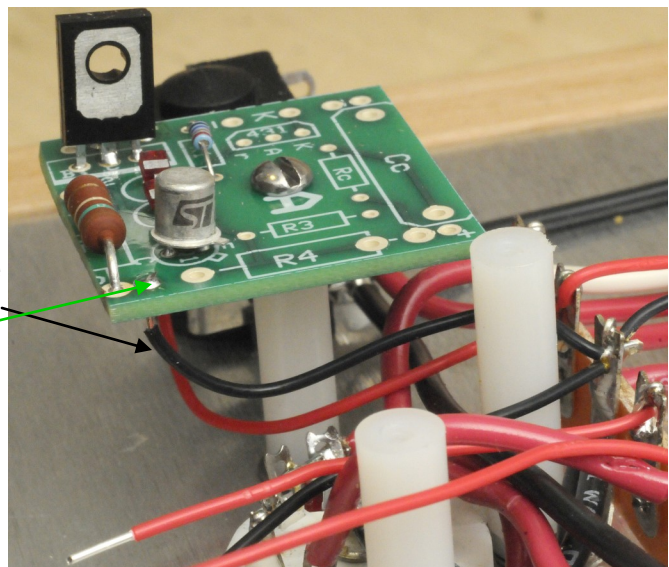

() Mount the right side green board with a #4x1/4" screw.

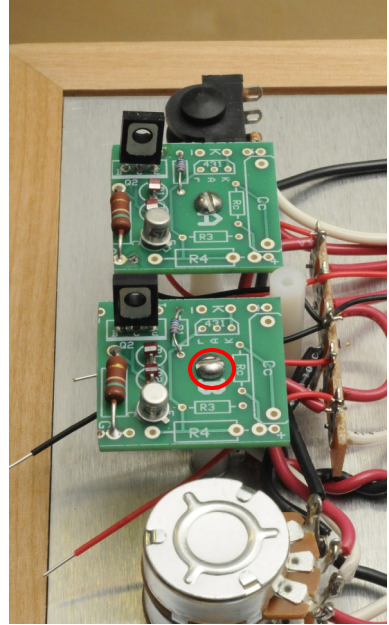
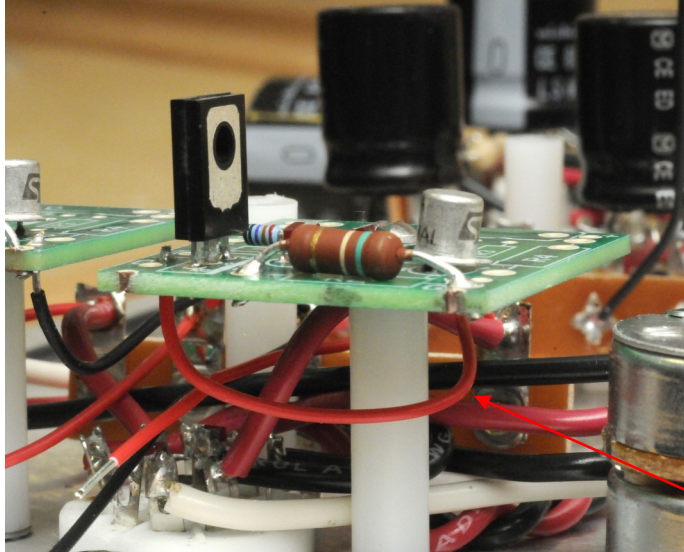

Attach and solder the outermost left red wire (5U) to one of the two pads labeled O.

Attach and solder the inner red wire (4U) to the pad labeled I.

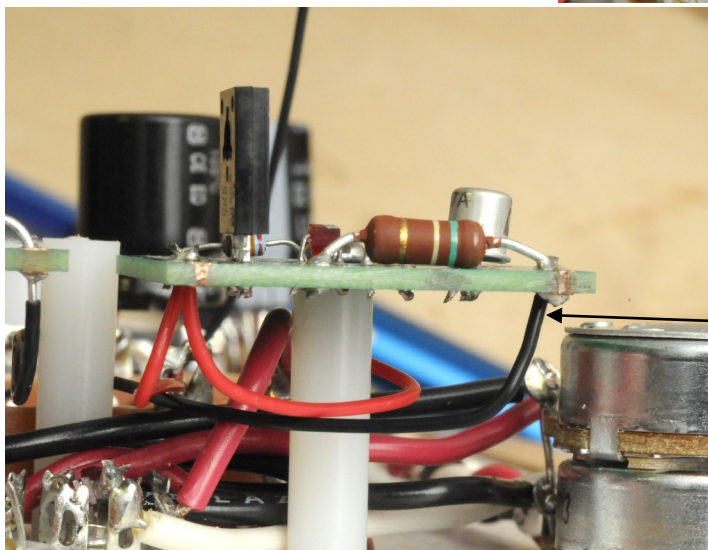
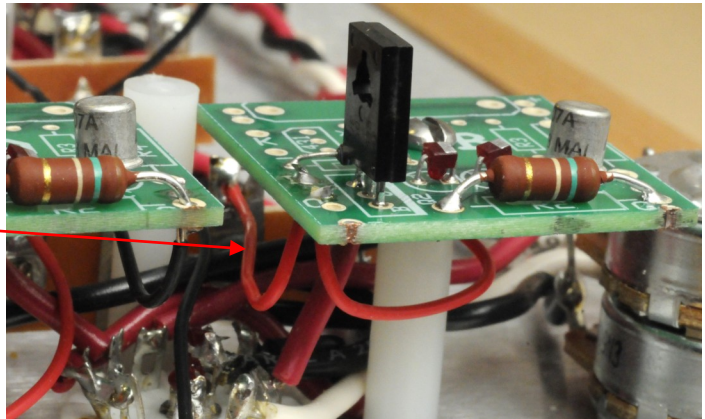

Attach and solder the remaining black wire to the pad labeled G. Note: the "G" may not be visible on the board. The pad is next to the outboard end of the 150K ohm resistor.

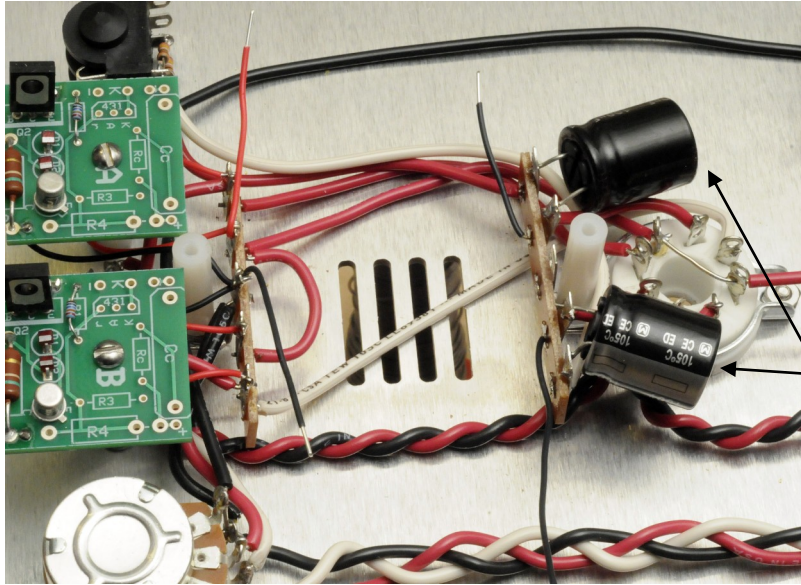

() Bend the remaining four leads toward the edges of the chassis as shown below. Also bend the two 100uf 160v electrolytic capacitors over towards the octal socket.

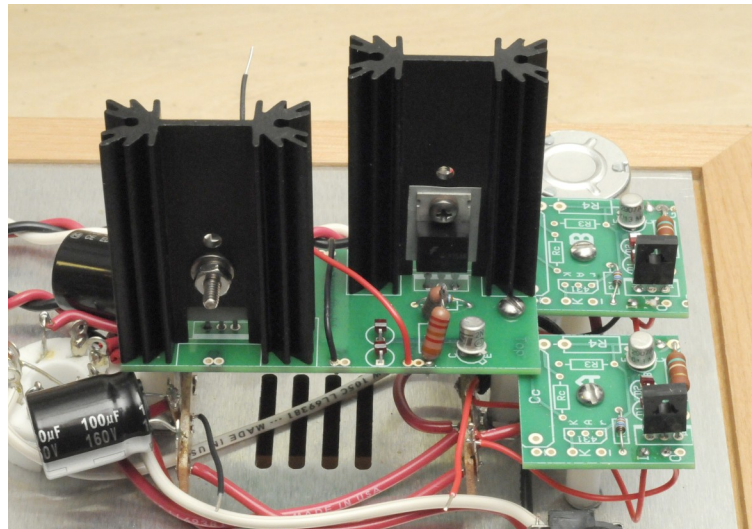

Mount the large PC board with two #4 x 1/4" screws.

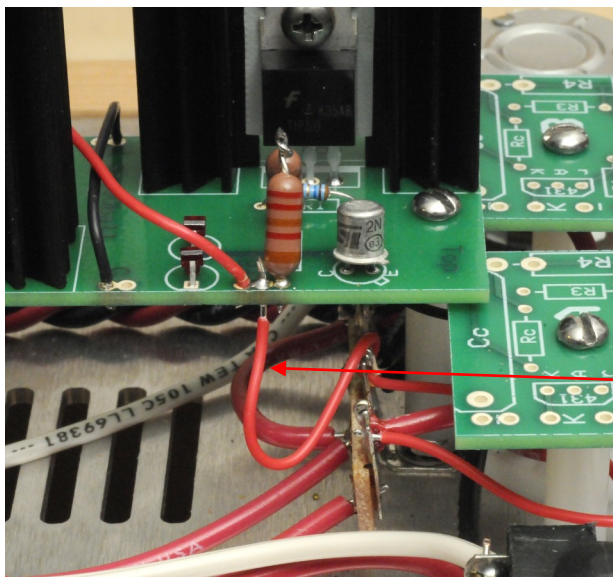

Attach and solder the red wire from 2U to the B+ pad on the left side of the PC board.

Attach and solder the black wire from 7L to the O pad on the left side of the PC board.

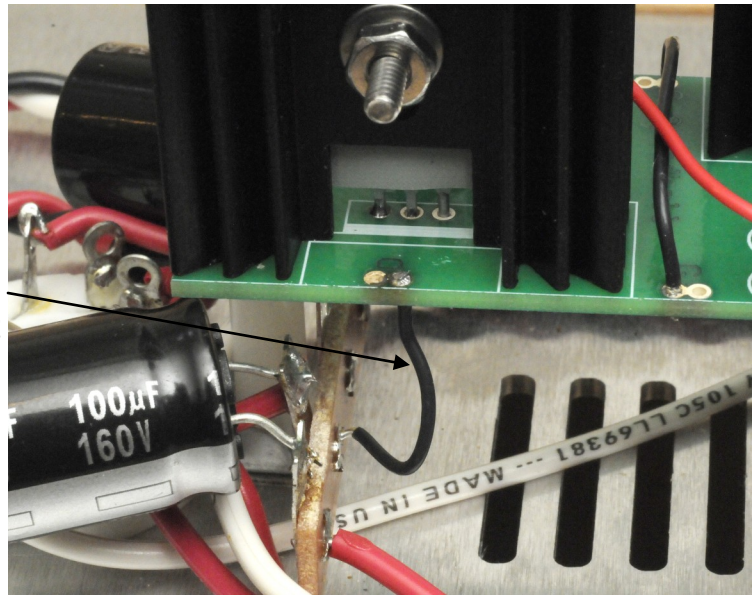

Attach and solder the black wire from 3U to the G pad on the right side of the PC board.

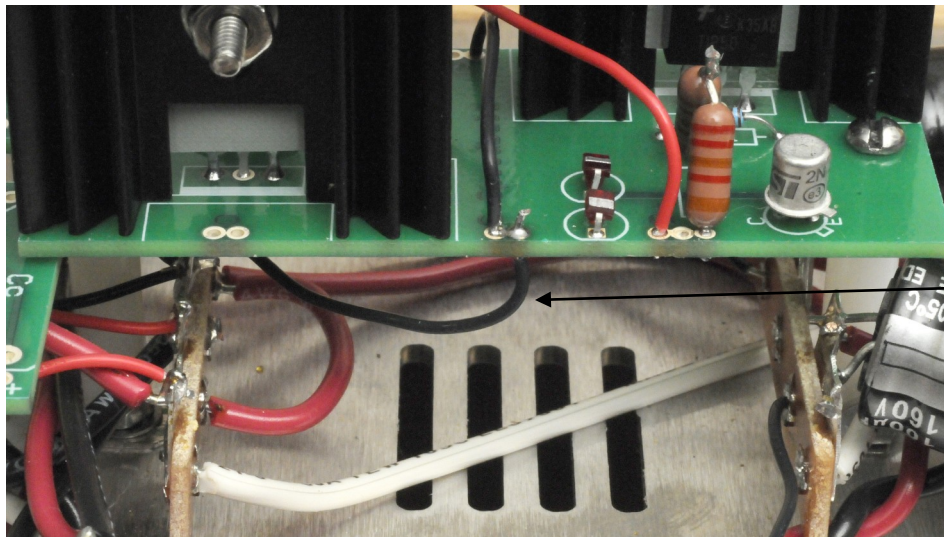

Attach and solder the black wire from 9L to the O pad on the right side of the PC board.

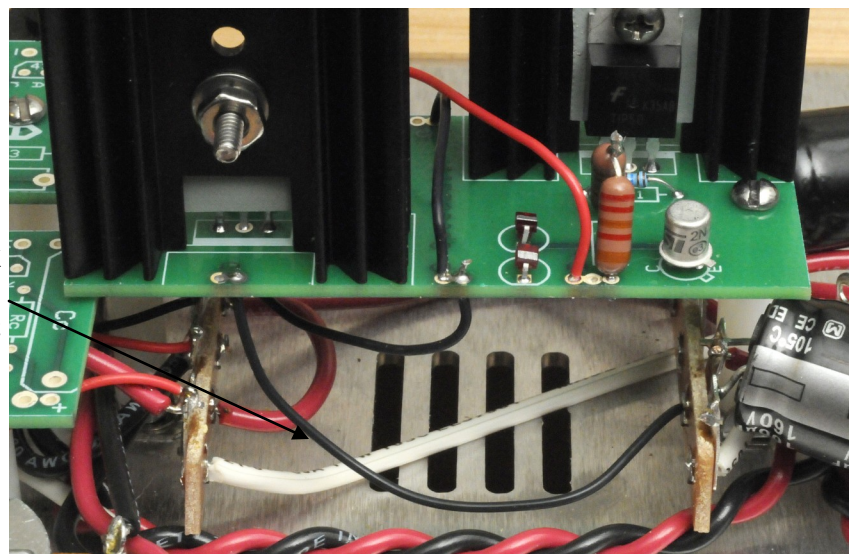

You're done building!

Congratulations! That completes the soldering portion of the assembly. **Now go back and make sure every joint that has components attached is properly soldered.** 90% of the troubleshooting issues that kit builders have are due to bad solder joints. Make sure that any excess leads are trimmed nice and close to the terminal. Double check your connections against the photos to be sure everything is connected to the proper terminal. Make sure that no leads are touching something they should not be touching. Neatness counts! It may help to have someone else look over your work too. Our head of R&D Paul Joppa says having someone else check your work will reduce the possibility of a mistake sneaking through by a factor of 1000. He was a math major who once worked for an actuarial compiling huge columns of numbers before he became an acoustical engineer, so he probably knows what he's talking about... Lastly, be sure to pick up the chassis, flip it over so the top is up, and gently shake it to shake out any loose wire trimmings that might short your wiring.

OK, now you can put that hot iron away and grab you're volt-ohmmeter.

The completed Crack output transformerless tube headphone amplifier with Speedball Upgrade

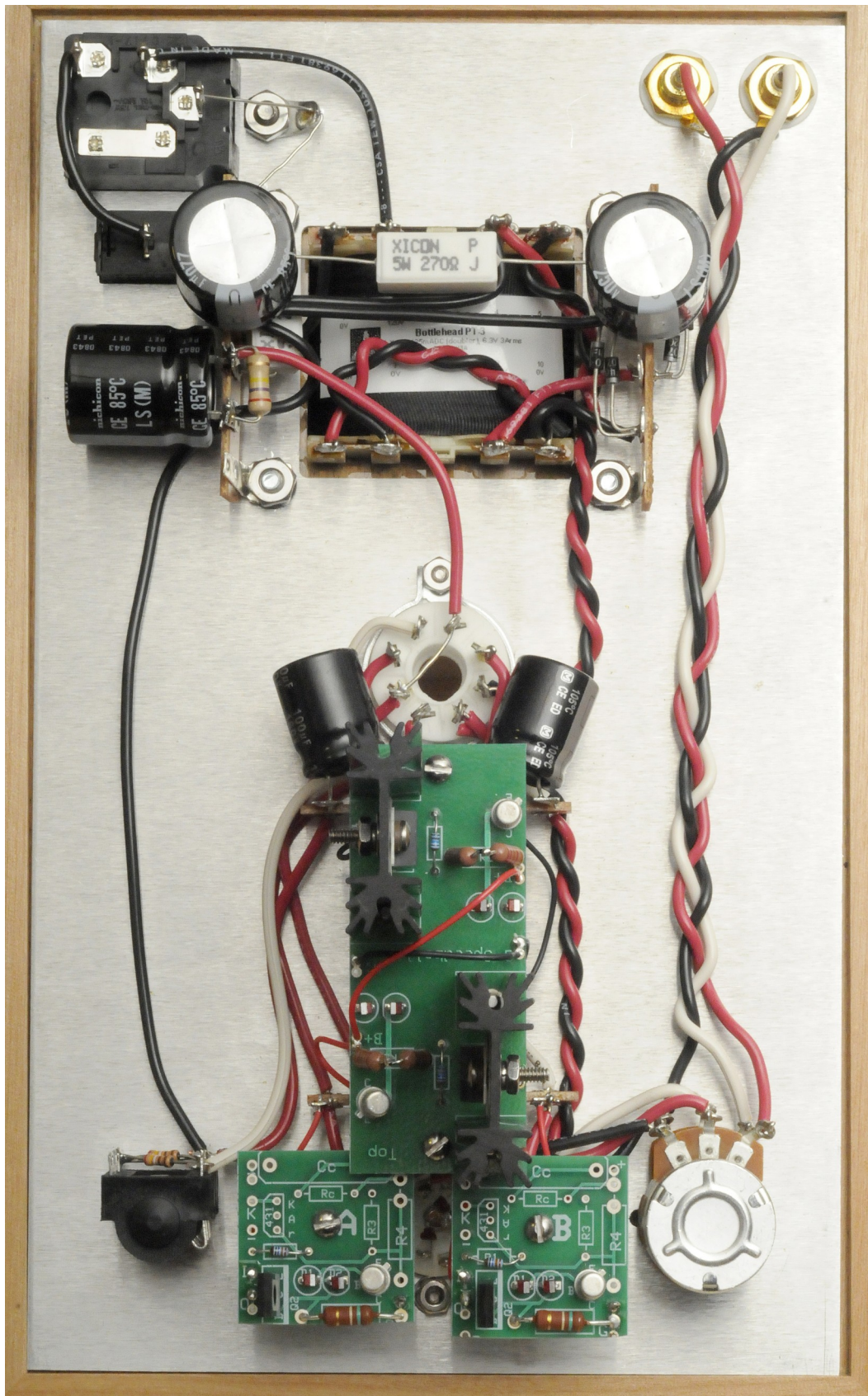

Voltage Check

This will help to assure that parts have been connected to the proper terminals and soldered properly before you connect a source and headphones to the circuit.

- () Turn the volume control all the way down.
- () Install the 12AU7 and 6080/6AS7 tubes in their sockets.
- () Clip the fuse into the fuse cover and insert the cover into the power entry module.
- () Plug the IEC power cord into the power entry module. Do not plug the cord into the wall yet.
- () Turn the chassis over and attach the negative lead (typically black) of a volt-ohm meter to ground. A good spot to do so is at terminal 12. Use of a clip lead to connect the black test lead to the ground will free one hand, making testing much easier and safer. Switch the meter to read DC volts on the 400V or higher scale.
- () Plug in the amplifier and turn on the power switch. If the tube filaments do not glow after a few seconds, power down and check the fuse. If it is blown, recheck your wiring one more time. Correct mis-wires, replace the fuse and try again.
- () If the tube filaments glow properly, wait at least thirty seconds and then CAREFULLY measure voltages using the positive lead (typically red) of the volt-ohm meter at the following terminals:

WHOA! SAFETY CHECK!

ALWAYS USE EXTREME CAUTION WHEN MAKING VOLTAGE MEASUREMENTS ON A LIVE PIECE OF ELECTRONIC GEAR.

Always wear rubber soled shoes when working on electronic gear, particularly if you are working on a concrete floor. Don't work in socks or bare feet. A circuit can be created from the live preamplifier to ground through your feet.

NEVER, REPEAT, **NEVER** TOUCH THE LIVE AMPLIFIER WITH BOTH HANDS WHEN TESTING. IF YOU CREATE A CLOSED CIRCUIT THROUGH YOUR HANDS AND ARMS, THE VOLTAGE AND CURRENT CAN STOP YOUR HEART. The old timers would keep one hand in their pocket when working with live gear to avoid a fatal slip up. Also, it is a bit safer to use your right hand than your left to touch the chassis, as any current passing through your hand to the ground would be less likely to pass through your heart. The following voltages have been made with an AC mains voltage of 119VAC:

Terminal	Voltage (VDC unless otherwise specified)
1	75-90
2	170
3	0
4	170
5	75-90
6	0
7	100
8	0
9	100
10	0
11	0
12	0
13	170
14	0

15	185
20	0
21	206

Don't worry if your voltages are not exactly these figures. Line voltage variations and tube tolerance variations can change them by up to 10-15%. If everything checks out go on to the next step.

If you do have a voltage problem and can't sort it out or you run into any other hitches, try asking for help on the Bottlehead Forum. It's a wonderful tech support resource—
<http://www.bottlehead.com/smf/index.php/>

Final check—important!

Power the amp down and wait for 5 minutes. With the red probe now touching either the Tip or Ring terminal on the headphone TRS jack, switch the amplifier on and monitor the voltage of the tip or ring for about 30 seconds. It should not climb higher than about 9 volts and should then drop to zero. If it climbs much higher and/or does not reduce to zero do not plug in headphones until you have worked out the issue and the voltage stays below 9V.

OK, if everything checks out, shut it down and disconnect the meter.

- () Connect a source to the inputs.
- () Plug in your headphones.

So what are you waiting for? Throw on some music! But do make sure the volume is turned down first so you don't inadvertently damage your headphones.

Basic Troubleshooting - A Rationale

One of the most tense and frustrating moments in the adventures of a Do-It-Yourselfer is when the project we have finished fails to "start right up the first time".

Fear not, this happens to everyone, even veterans with years of construction experience.

There are a few general, logical techniques to troubleshooting that can make the process a lot less painful and actually quite a rewarding lesson. Remember, we don't learn from doing something right, we learn from our mistakes. So forget the panic, take a deep breath, and get analytical for a moment...

Equipment

While a really hot shot tech might be able to diagnose a few problems based entirely on his past experience with a particular circuit, one really needs a minimal collection of test gear to sort out a problem. Most important (and most likely to show the location of the typical problem) is the Volt-Ohm meter, whether an analog meter or a digital voltmeter (a.k.a. DVM or DMM). Along with this a few clip leads can be a tremendous help in hooking up meters, substitute parts, etc. For real "tough dogs" and new designs an oscilloscope is almost mandatory, but we will deal here with the more straight forward kinds of problems that are usually encountered when one completes an electronics kit.

An Example

Let's create a scenario to help us understand the troubleshooting process. You've been playing your preamp for a couple of hours, and suddenly you started hearing a noise in one channel of your system. It's making you crazy, and you're wondering how you ever talked yourself into the idea that you could build your own gear.

Rule number ONE

Break the system into its component parts

I cannot emphasize this enough. The first step is to determine where in the system and/or where in the component the problem lies. This is done by the process of elimination.

So let's slow down and get logical. Start by eliminating the parts that we know aren't broken. First we know the problem is only in one channel. So let's not bother with the other channel, in fact if we can turn the amp off on the channel that's OK, let's do so.

Now let's disconnect the preamp from the amp on the noisy side. Shut the amp and preamp off and disconnect the interconnect between them. What we want to do now is to short the input of the amp. You can do this with a shorting plug, which is just an RCA plug that has the center pin connected to the outer shell, or you can just use a clip lead to short the center conductor of the RCA jack in the amp to the ground tab on the RCA jack. Turn on the amp and see if you hear the noise.

For grins let's say you don't hear the noise. OK, now you know that the problem is not in the amp. So it must be in the preamp or the source component ahead of the preamp (i.e. your CD player, DAC, or phono setup). Now shut everything down again, hook the preamp back up to the amp, and disconnect the source component from the preamp input. Once again use your shorting jack or trusty clip lead, this time on the preamp input. Fire the system up and listen.

Let's assume that we hear the noise. OK, now we know that it's not the amp, not the source, so it must be a problem in the preamp.

Rule number TWO

Analyze the component parts of the equipment in question

Now we need to figure out exactly what is wrong inside our preamp.

First off, let's think about how the circuit is developed. For sake of argument let's assume we are looking at a Foreplay preamp. There's a power supply, and following that there's two separate preamp circuits, one for each channel. Each of those preamp circuits is divided into a gain stage and a cathode follower stage.

OK, what can we assume so far? Well, we know that the noise is only in one channel. And we know that the same power supply supplies both channels. So we may deduce that the problem lies somewhere beyond the power supply in this case, or it would affect both channels.

Rule number THREE

Start with the easy stuff

OK, so the problem must be in the preamp circuit of the channel that's making the noise. So, what's the most obvious, easy thing to try first? Of course it's swapping the tubes from side to side. If we swap tubes between the left and right channels, and the noise follows one of the tubes, you are done. Time to get a new tube.

But let's not just end our story here. We'll assume the noise stayed in the same channel when we swapped tubes.

Rule number FOUR

Measure your voltages

At this point it's time to turn our preamp over and examine it's guts. You need to go back through the check out voltage measurements for the channel in question. Better yet, re-measure all your voltages. Log this info, so that if you need to call us for advice, we have some info to work with.

Let's say you've checked to make sure that your component wiring matches the drawing or photo provided in your kit, but you find a funny voltage in there somewhere. Look at the components attached to the terminal you are measuring. In particular, make sure they are in the right place, and that the solder joints look good. Shut the preamp off, and measure the resistance at the same points as you measured the voltages. A funny reading may lead you to the problem.

Rule number FIVE

Resolder your joints

In our case of a funny noise being generated, one of my hunches would be that we have a broken ground somewhere. The most likely culprit would be a bad solder joint. Once again I must get on my high horse. **Just looking at a solder joint tells you absolutely nothing about it's electrical integrity.** The only way to be sure a solder joint in question is good is to carefully re-solder it, adding a little solder in the process. And then re-measuring the resistance and voltage measurement at the terminal in question. Heat and patience are the solution.

The old kit companies like Heathkit and Dynaco had a statement in their manuals that 99% of problems with a kit were due to cold solder joints. Still holds true today.

In our case, we found a cold solder joint at the ground buss, resoldered it, and now we have clean uninterrupted music.

Some tips

Different sounds can indicate different problems.

Deep hum without any buzz - this is 120Hz hum, and is usually encountered in DHT amps. Usually a touch up of the hum balance pot will eliminate it

Buzzy hum, like a bee - This usually means a lifted ground connection. Usually fixed with a careful examination of solder joints and an arbitrary re-solder job

Scratchy sound, hissing, crackling, popping - usually a bad tube, but if just one of these four types of noises is heard, it can also be caused by a bad capacitor or resistor.

Popping on start-up - usually a grid short in the output tube causes this. It will often clear itself and the amp will play OK.

Microphony, a tendency to ring when tapped or a loud musical transient plays - again this is most often due to a bad tube, but on rare occasion a capacitor can create this symptom too.

No sound - something isn't getting voltage or it isn't getting signal. Before you dive in to tear things apart, check the obvious - are your speaker cables hooked up properly? Interconnects? Is everything switched on? We see some slightly embarrassing moments at Bottlehead meetings, where the equipment is often swapped in and out of the system at a frantic pace. About 95% of the time a "dead" piece of gear just isn't hooked up right.

Muffled sound - this usually means something is not getting all the voltage it is supposed to get, and that you need to get inside the equipment and start taking voltage measurements.

Pay attention to the LEDs on C4S boards

If a board doesn't light up, be sure to check out your component numbers, orientation on the PC board, and solder joints. To test the transistors, put your meter leads across each of the three possible combinations of transistor leads and test for resistance. If you get a very low resistance reading at any pair, the transistor is blown. Reversed LEDs are another fairly common problem.

Last tip -

If you see smoke, SHUT IT OFF!!!

Doc B.

Guarantee

Bottlehead Corp. guarantees prompt replacement of any parts which may be missing from the kit upon receipt. Call 206-451-4275 to receive replacements for missing parts. If any parts have been damaged in shipment, replacements will be sent to the purchaser upon return of the damaged parts.

Bottlehead Corp. is unable to accept for refund any kit upon which assembly has begun.

Returns of unbuilt kits require prior authorization and must be returned within two weeks of receipt.

If you wish to have the kit assembled for you, contact us at 206-451-4275 and we will refer you to a factory authorized assembly technician.

If you have technical questions regarding assembly of the kit, call 206-451-4275 during regular business hours or visit the Bottlehead Forum at <http://www.bottlehead.com/smf/index.php>

Mailing and Shipping Address:

Bottlehead Corporation

9415 Coppertop Loop NE, Suite 101
Bainbridge Island, WA 98110

Voice Phone: 206-451-4275

E-mail: queen@bottlehead.com