

The RF MOSFET Line  
**RF Power**  
**Field-Effect Transistor**  
**N-Channel Enhancement-Mode**

Designed for broadband commercial and military applications using single ended circuits at frequencies to 500 MHz. The high power, high gain and broadband performance of this device makes possible solid state transmitters for FM broadcast or TV channel frequency bands.

- Guaranteed Performance @ 500 MHz, 28 Vdc  
Output Power — 100 Watts  
Power Gain — 8.8 dB Typ  
Efficiency — 55% Typ
- 100% Ruggedness Tested At Rated Output Power
- Low Thermal Resistance
- Low  $C_{rss}$  — 17 pF Typ @  $V_{DS} = 28$  Volts
- S-Parameters Available for Download into Frequency Domain Simulators.  
See <http://motorola.com/sps/rf/designtds/>

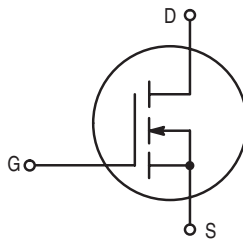

**MRF275L**

100 W, 28 V, 500 MHz  
**N-CHANNEL**  
**BROADBAND**  
**RF POWER FET**

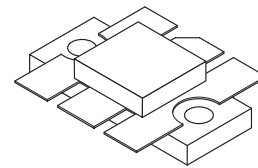

**CASE 333-04, STYLE 2**

**MAXIMUM RATINGS**

Rating	Symbol	Value	Unit
Drain-Source Voltage	$V_{DSS}$	65	Vdc
Gate-Source Voltage	$V_{GS}$	$\pm 20$	Vdc
Drain Current — Continuous	$I_D$	13	Adc
Total Device Dissipation @ $T_C = 25^\circ\text{C}$ Derate above $25^\circ\text{C}$	$P_D$	270 1.54	Watts W/ $^\circ\text{C}$
Storage Temperature Range	$T_{stg}$	-65 to +150	$^\circ\text{C}$
Operating Junction Temperature	$T_J$	200	$^\circ\text{C}$

**THERMAL CHARACTERISTICS**

Characteristic	Symbol	Max	Unit
Thermal Resistance, Junction to Case	$R_{\theta JC}$	0.65	$^\circ\text{C}/\text{W}$

**ELECTRICAL CHARACTERISTICS** ( $T_C = 25^\circ\text{C}$  unless otherwise noted)

Characteristic	Symbol	Min	Typ	Max	Unit
----------------	--------	-----	-----	-----	------

**OFF CHARACTERISTICS**

Drain-Source Breakdown Voltage ( $V_{GS} = 0$ , $I_D = 50$ mA)	$V_{(BR)DSS}$	65	—	—	Vdc
Zero Gate Voltage Drain Current ( $V_{DS} = 28$ V, $V_{GS} = 0$ )	$I_{DSS}$	—	—	2.5	mAdc
Gate-Body Leakage Current ( $V_{GS} = 20$ V, $V_{DS} = 0$ )	$I_{GSS}$	—	—	1.0	$\mu\text{Adc}$

NOTE — **CAUTION** — MOS devices are susceptible to damage from electrostatic charge. Reasonable precautions in handling and packaging MOS devices should be observed.

**ELECTRICAL CHARACTERISTICS — continued** ( $T_C = 25^\circ\text{C}$  unless otherwise noted)

Characteristic	Symbol	Min	Typ	Max	Unit
----------------	--------	-----	-----	-----	------

**ON CHARACTERISTICS**

Gate Threshold Voltage ( $V_{DS} = 10\text{ V}$ , $I_D = 100\text{ mA}$ )	$V_{GS(th)}$	1.5	2.5	4.5	Vdc
Drain-Source On-Voltage ( $V_{GS} = 10\text{ V}$ , $I_D = 5.0\text{ A}$ )	$V_{DS(on)}$	0.5	0.9	1.5	Vdc
Forward Transconductance ( $V_{DS} = 10\text{ V}$ , $I_D = 2.5\text{ A}$ )	$g_{fs}$	3.0	3.75	—	mhos

**DYNAMIC CHARACTERISTICS**

Input Capacitance ( $V_{DS} = 28\text{ V}$ , $V_{GS} = 0$ , $f = 1.0\text{ MHz}$ )	$C_{iss}$	—	135	—	pF
Output Capacitance ( $V_{DS} = 28\text{ V}$ , $V_{GS} = 0$ , $f = 1.0\text{ MHz}$ )	$C_{oss}$	—	140	—	pF
Reverse Transfer Capacitance ( $V_{DS} = 28\text{ V}$ , $V_{GS} = 0$ , $f = 1.0\text{ MHz}$ )	$C_{rss}$	—	17	—	pF

**FUNCTIONAL CHARACTERISTICS**

Common Source Power Gain ( $V_{DD} = 28\text{ Vdc}$ , $P_{out} = 100\text{ W}$ , $f = 500\text{ MHz}$ , $I_{DQ} = 100\text{ mA}$ )	$G_{ps}$	7.5	8.8	—	dB
Drain Efficiency ( $V_{DD} = 28\text{ Vdc}$ , $P_{out} = 100\text{ W}$ , $f = 500\text{ MHz}$ , $I_{DQ} = 100\text{ mA}$ )	$\eta$	50	55	—	%
Electrical Ruggedness ( $V_{DD} = 28\text{ Vdc}$ , $P_{out} = 100\text{ W}$ , $f = 500\text{ MHz}$ , $I_{DQ} = 100\text{ mA}$ , VSWR 10:1 at all Phase Angles)	$\psi$	No Degradation in Output Power			

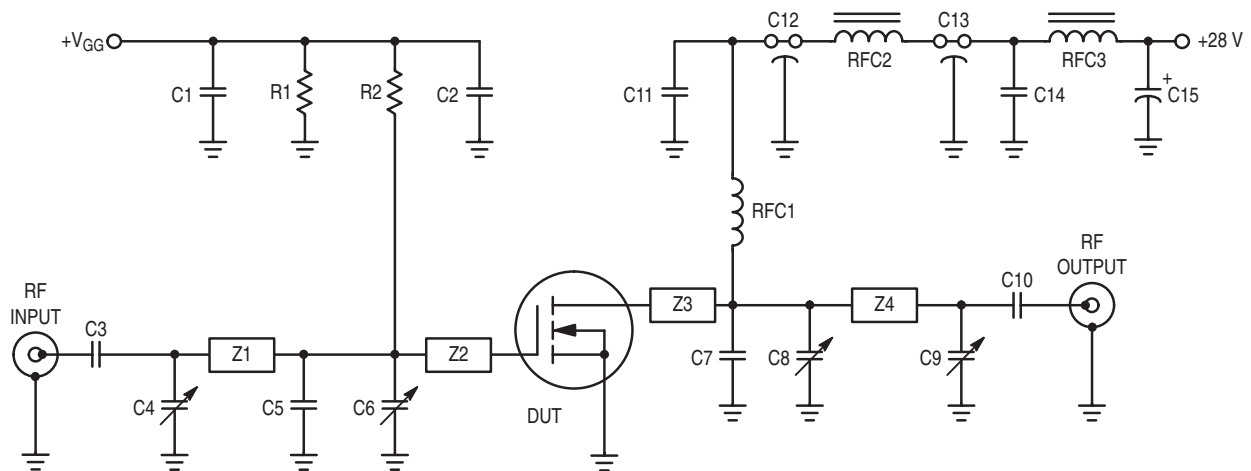

C1, C11, C14	0.1 $\mu\text{F}$ , Ceramic Capacitor	RFC1	8 Turns AWG #18, 0.25" I.D., Enameled
C2	240 pF, ATC Type Chip Capacitor	RFC2, RFC3	Ferroxcube VK200 19/4B
C3, C10	270 pF, ATC Type Chip Capacitor	Z1, Z2, Z3	0.250" x 0.800", Microstrip Line
C4, C6, C8, C9	1–20 pF, Trimmer Capacitor, Johansen	Z4	0.250" x 0.400", Microstrip Line
C5	24 pF, Mini-Unelco Type Capacitor	Board Material	0.250" x 1.25", Microstrip Line
C7	24 pF, Mini-Unelco Type Capacitor		0.062" Glass Teflon <sup>®</sup> , 2 oz. Copper, Double Clad Copper Board, $\epsilon_r = 2.55$
C12, C13	680 pF, Feedthru Capacitors		
C15	10 $\mu\text{F}$ , 50 V, Electrolytic Capacitor		

**Figure 1. 500 MHz Test Circuit**

## TYPICAL CHARACTERISTICS

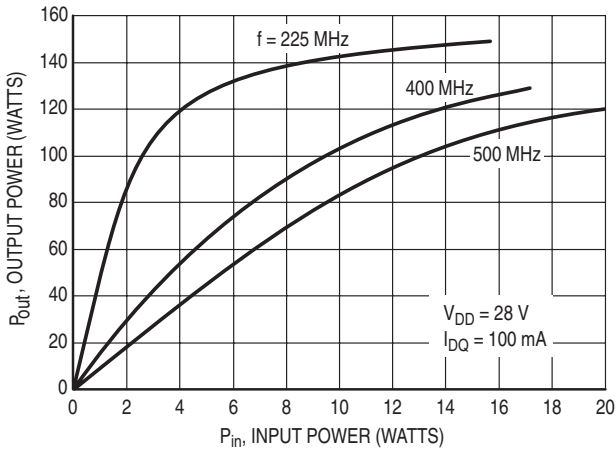

**Figure 2. Output Power versus Input Power**

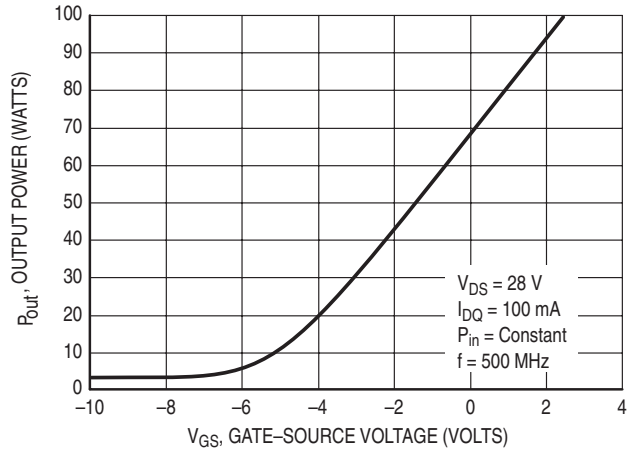

**Figure 3. Output Power versus Gate Voltage**

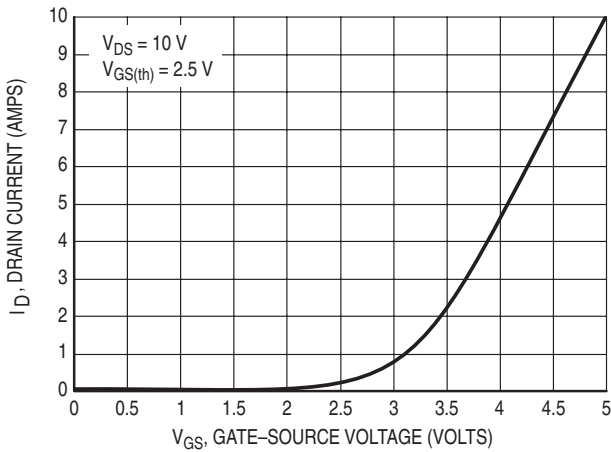

**Figure 4. Drain Current versus Gate Voltage (Transfer Characteristics)**

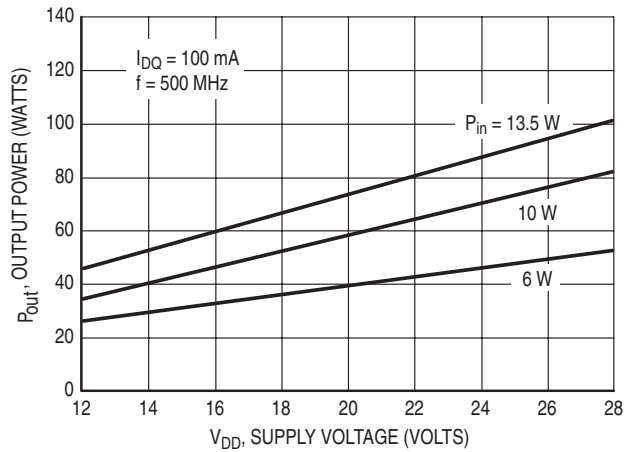

**Figure 5. Output Power versus Supply Voltage**

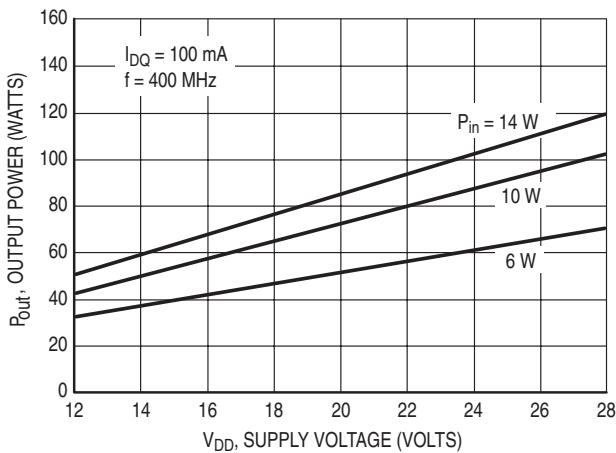

**Figure 6. Output Power versus Supply Voltage**

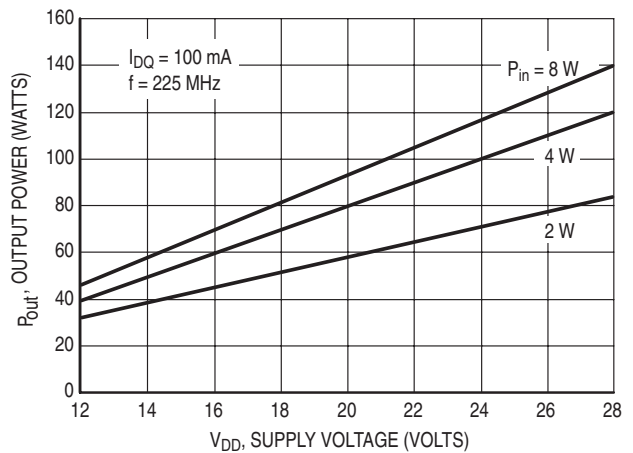

**Figure 7. Output Power versus Supply Voltage**

## TYPICAL CHARACTERISTICS

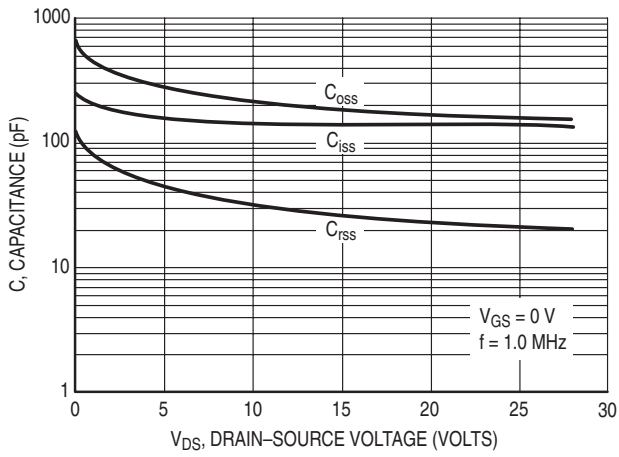

Figure 8. Capacitance versus Drain-Source Voltage

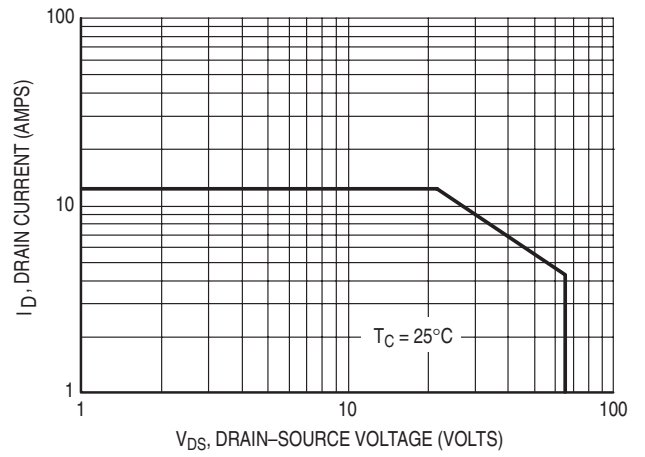
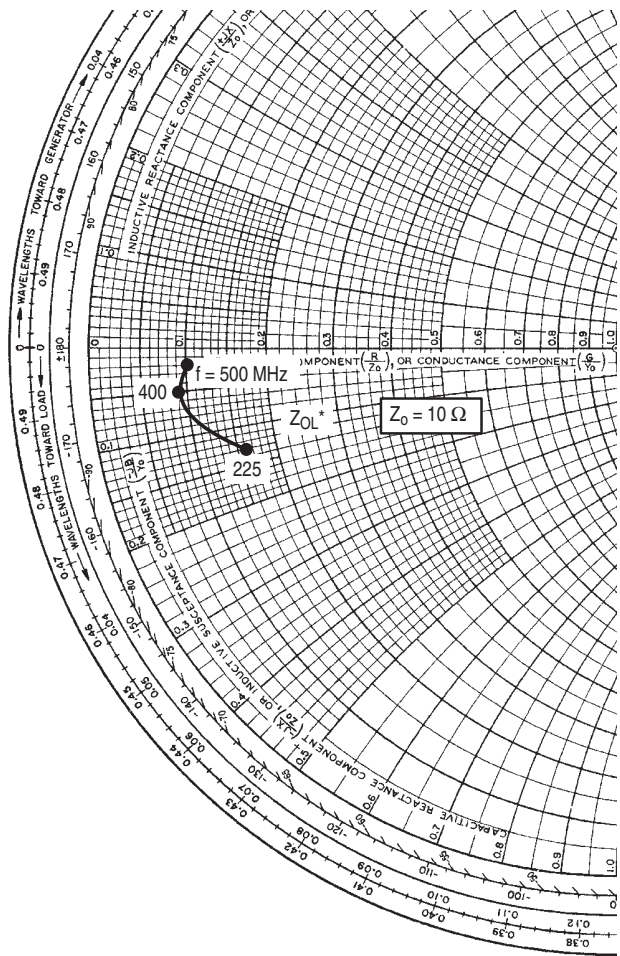
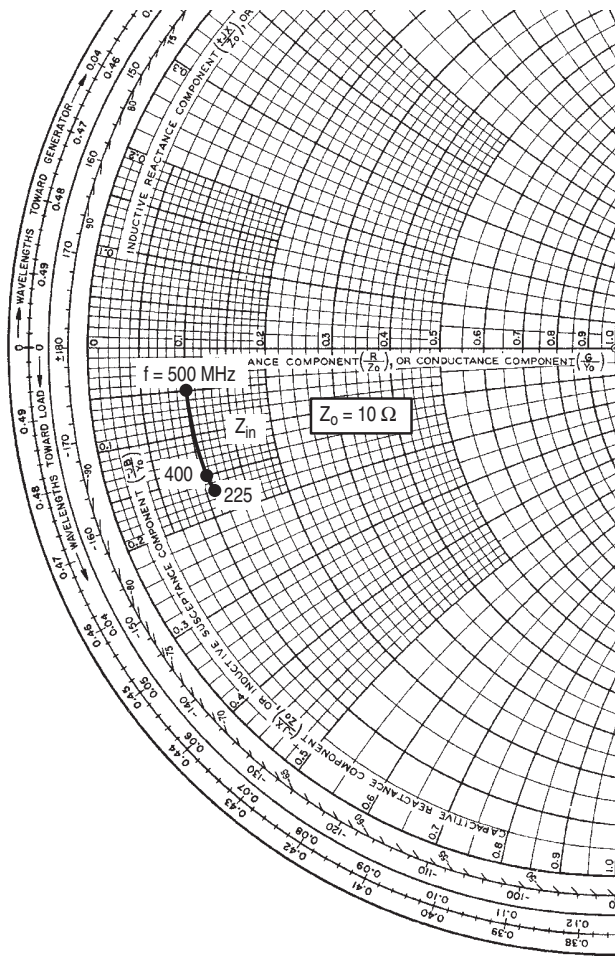

Figure 9. DC Safe Operating Area



$V_{DD} = 28\text{ V}$ ,  $I_{DQ} = 100\text{ mA}$ ,  $P_{out} = 100\text{ W}$

f (MHz)	$Z_{in}$ Ohms
225	$1.1 - j1.7$
400	$1.08 - j1.5$
500	$1.0 - j0.5$

$V_{DD} = 28\text{ V}$ ,  $I_{DQ} = 100\text{ mA}$ ,  $P_{out} = 100\text{ W}$

f (MHz)	$Z_{OL}^*$ Ohms
225	$1.6 - j1.3$
400	$0.9 - j0.5$
500	$1.0 - j0.2$

$Z_{OL}^*$  = Conjugate of the optimum load impedance into which the device operates at a given output power, voltage and frequency.

Figure 10. Series Equivalent Input/Output Impedance

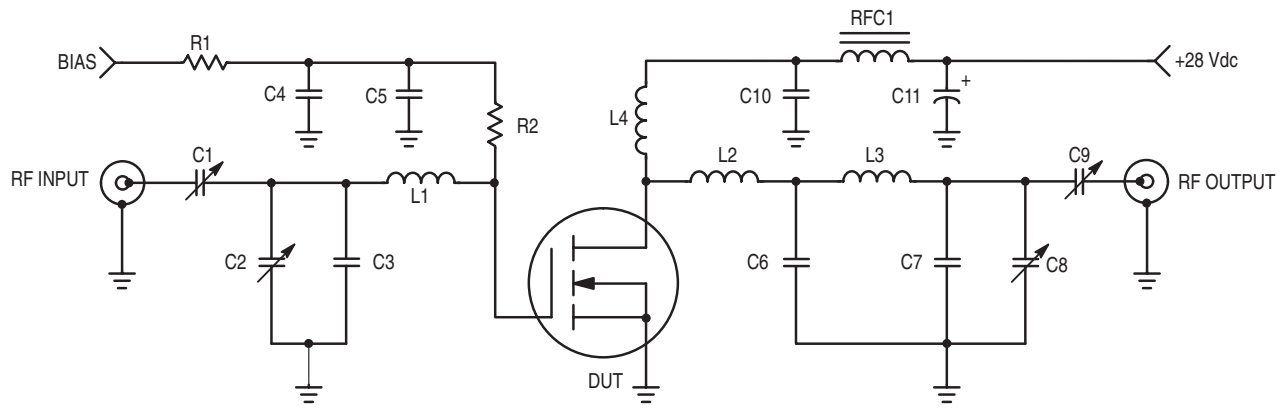

- |            |   |    |                                    |      |                            |
|------------|---|----|------------------------------------|------|----------------------------|
| C1, C2, C8 | Arco 463 or Equivalent                    | L1 | Hairpin Inductor #18 Wire          | L3   | Hairpin Inductor #16 Wire  |
| C3, C7     | 25 pF, Unelco Capacitor                   |    |                                    |      |                            |
| C4         | 1000 pF, Chip Capacitor                   |    |                                    |      |                            |
| C5         | 0.01 $\mu$ F, Chip Capacitor              |    |                                    |      |                            |
| C6         | 250 pF, Unelco Capacitor                  |    |                                    |      |                            |
| C9         | Arco 462 or Equivalent                    |    |                                    |      |                            |
| C10        | 1000 pF, ATC Chip Capacitor               |    |                                    |      |                            |
| C11        | 10 $\mu$ F, 100 V, Electrolytic Capacitor | L2 | Stripline Inductor 0.200" x 0.500" | L4   | 2 Turns #16 Wire, 5/16" ID |
|            |   |    |                                    | RFC1 | VK200-4B                   |
|            |   |    |                                    | R1   | 1.0 k, 1/4 W Resistor      |
|            |   |    |                                    | R2   | 100 $\Omega$ Resistor      |

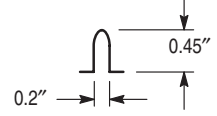
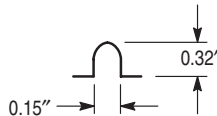
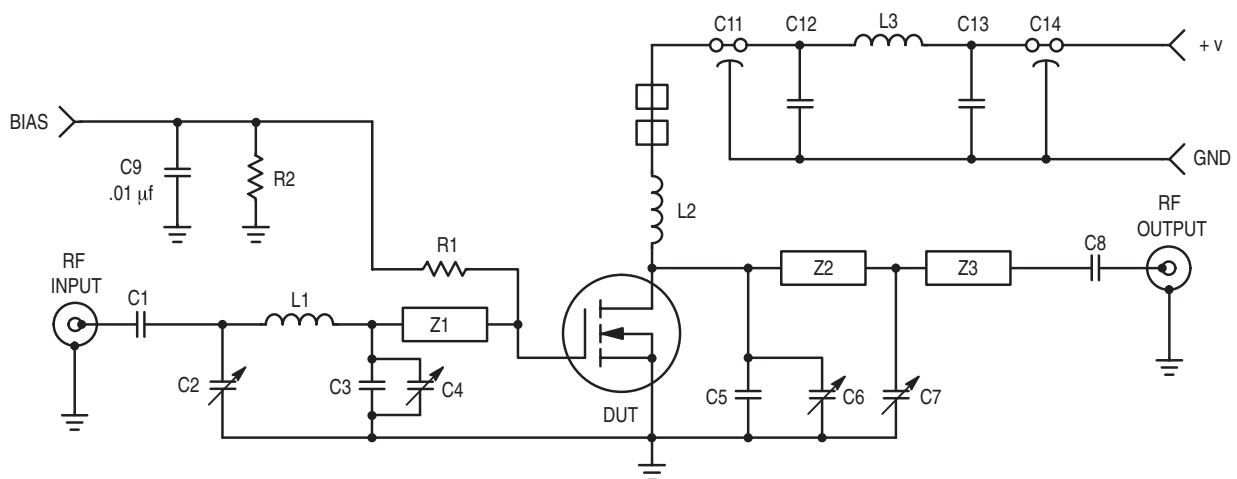

Figure 11. 225 MHz Test Circuit



- |                |                                |    |                              |                |   |
|----------------|--------------------------------|----|------------------------------|----------------|---|
| C1, C8         | 270 pF, ATC Chip Capacitor     | L1 | Hairpin Inductor #18 Wire    | R1             | 10 k, 1/4 W Resistor  |
| C2, C4, C6, C7 | 1.0–20 pF, Trimmer Capacitor   |    |                              | R2             | 1 k, 1/4 W Resistor   |
| C3             | 15 pF, Mini Unelco Capacitor   |    |                              | R3             | 1.5 k, 1/4 W Resistor   |
| C5             | 47 pF, Mini Unelco Capacitor   |    |                              | Z1             | 0.950" x 0.250", Microstrip Line  |
| C9, C12        | 0.1 $\mu$ F, Ceramic Capacitor |    |                              | Z2             | 1.25" x 0.250", Microstrip Line   |
| C11, C14       | 680 pF, Feed Thru Capacitor    |    |                              | Z3             | 0.300" x 0.250", Microstrip Line  |
| C13            | 50 $\mu$ F, Tantalum Capacitor | L2 | 12 Turns #18 Wire, 0.450" ID | Board Material | 0.062" Teflon <sup>®</sup> ,<br>Fiberglass, 1 oz. Copper,<br>Clad Both Sides, $\epsilon_r = 2.56$ |
|                |                                | L3 | Ferroxcube VK200 20/4B       |                |   |

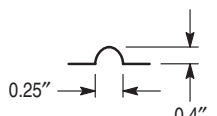
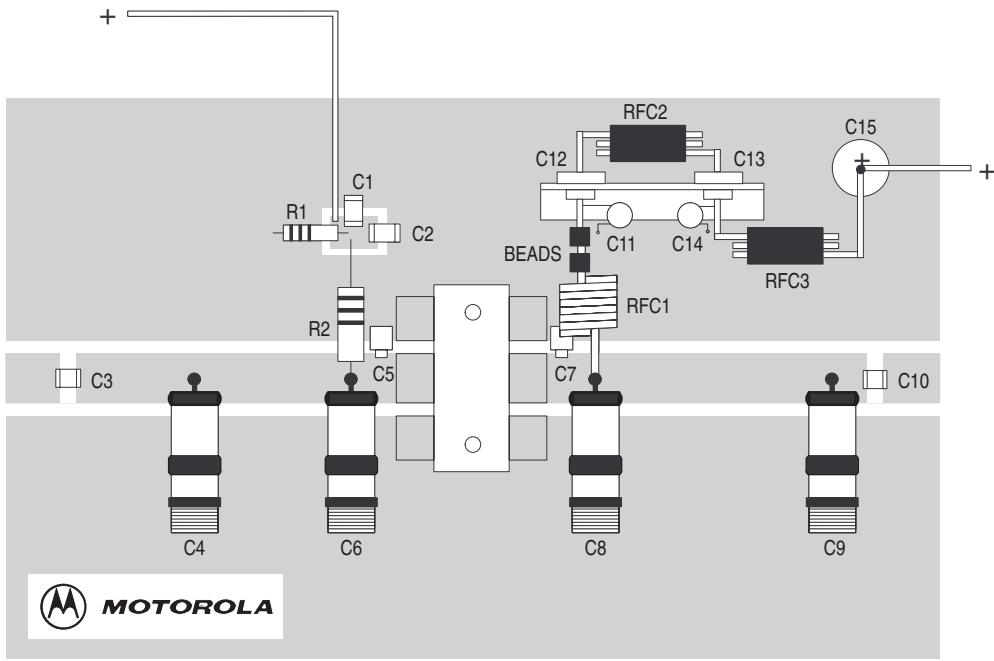
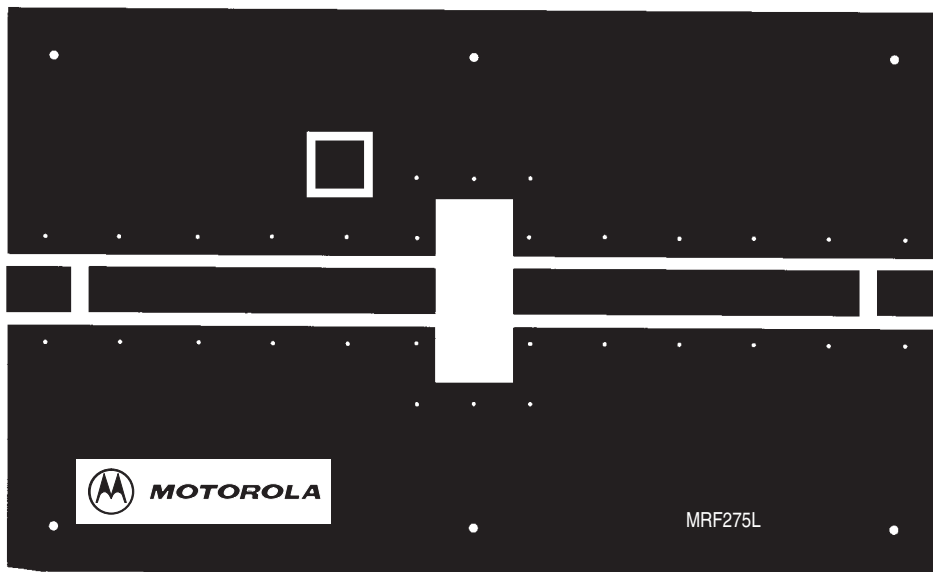

Figure 12. 400 MHz Test Circuit



(Not to Scale)

Figure 13. MRF275L Component Location (500 MHz)



(Scale 1:1)

Figure 14. MRF275L Test Circuit Photomaster  
(Reduced 25% in printed data book, DL110/D)

Table 1. Common Source S-Parameters ( $V_{DS} = 12.5\text{ V}$ ,  $I_D = 4.5\text{ A}$ )

f MHz	S <sub>11</sub>		S <sub>21</sub>		S <sub>12</sub>		S <sub>22</sub>	
	S <sub>11</sub>	φ	S <sub>21</sub>	φ	S <sub>12</sub>	φ	S <sub>22</sub>	φ
30	0.936	-176	6.22	87	0.010	21	0.944	-179
40	0.938	-178	4.28	87	0.010	24	0.930	-177
50	0.937	-178	3.65	83	0.010	29	0.922	179
60	0.937	-179	2.99	83	0.011	34	0.920	179
70	0.938	-179	2.54	81	0.011	39	0.917	179
80	0.938	-179	2.18	80	0.012	42	0.913	179
90	0.939	-180	1.94	78	0.012	44	0.909	180
100	0.939	-180	1.77	77	0.013	47	0.913	-180
110	0.939	180	1.57	77	0.015	50	0.916	-179
120	0.940	180	1.45	74	0.015	54	0.914	179
130	0.940	179	1.34	75	0.016	57	0.935	180
140	0.940	179	1.26	72	0.016	58	0.943	180
150	0.940	179	1.19	71	0.017	57	0.951	178
160	0.941	179	1.09	70	0.019	58	0.943	179
170	0.941	179	1.01	69	0.019	62	0.940	180
180	0.941	179	0.956	68	0.021	64	0.948	179
190	0.941	178	0.912	67	0.022	65	0.957	180
200	0.942	178	0.860	65	0.022	65	0.941	178
210	0.942	178	0.816	64	0.023	65	0.931	178
220	0.943	178	0.779	63	0.025	66	0.922	178
230	0.943	177	0.717	60	0.027	67	0.965	177
240	0.943	177	0.709	61	0.026	68	0.927	176
250	0.944	177	0.674	60	0.026	70	0.924	178
260	0.944	177	0.645	58	0.028	69	0.930	179
270	0.944	177	0.627	57	0.030	70	0.933	178
280	0.945	176	0.608	58	0.032	70	0.940	177
290	0.946	176	0.580	54	0.031	71	0.941	175
300	0.946	176	0.569	56	0.033	71	0.945	176
310	0.946	176	0.539	55	0.033	72	0.953	178
320	0.947	175	0.512	54	0.035	71	0.952	177
330	0.948	175	0.483	51	0.037	72	0.927	176
340	0.947	175	0.477	52	0.038	72	0.921	176
350	0.947	175	0.466	51	0.039	75	0.929	178
360	0.947	175	0.459	51	0.040	73	0.963	177
370	0.948	174	0.441	50	0.043	71	0.968	175
380	0.949	174	0.428	49	0.044	72	0.937	175
390	0.949	174	0.417	49	0.045	74	0.907	176
400	0.949	174	0.409	47	0.044	77	0.912	177
410	0.950	173	0.390	46	0.046	74	0.962	175
420	0.950	173	0.377	45	0.047	71	0.971	174
430	0.950	173	0.369	45	0.050	72	0.948	176



**Table 1. Common Source S-Parameters ( $V_{DS} = 12.5\text{ V}$ ,  $I_D = 4.5\text{ A}$ ) continued**

f MHz	S <sub>11</sub>		S <sub>21</sub>		S <sub>12</sub>		S <sub>22</sub>	
	S <sub>11</sub>	φ	S <sub>21</sub>	φ	S <sub>12</sub>	φ	S <sub>22</sub>	φ
440	0.951	173	0.368	47	0.052	74	0.953	176
450	0.951	172	0.371	42	0.053	76	0.943	175
460	0.952	172	0.347	44	0.053	72	0.965	172
470	0.952	172	0.331	43	0.053	71	0.933	173
480	0.953	172	0.323	43	0.056	71	0.936	173
490	0.953	171	0.317	41	0.059	72	0.965	173
500	0.954	171	0.306	41	0.061	74	0.963	173
600	0.957	168	0.267	35	0.069	77	0.941	171
700	0.965	165	0.224	35	0.090	70	0.958	169
800	0.967	160	0.219	32	0.099	67	0.937	164
900	0.980	156	0.214	33	0.114	69	0.943	164
1000	0.986	151	0.218	34	0.146	67	0.955	162

**Table 2. Common Source S-Parameters ( $V_{DS} = 24\text{ V}$ ,  $I_D = 4.5\text{ A}$ )**

f MHz	S <sub>11</sub>		S <sub>21</sub>		S <sub>12</sub>		S <sub>22</sub>	
	S <sub>11</sub>	φ	S <sub>21</sub>	φ	S <sub>12</sub>	φ	S <sub>22</sub>	φ
30	0.914	-174	9.08	87	0.011	19	0.882	-178
40	0.918	-176	6.29	86	0.011	22	0.876	-176
50	0.918	-177	5.31	82	0.011	26	0.871	180
60	0.917	-177	4.35	82	0.012	29	0.871	-179
70	0.919	-178	3.70	79	0.012	32	0.865	-179
80	0.919	-178	3.16	77	0.013	37	0.857	-179
90	0.920	-179	2.81	75	0.013	42	0.851	-180
100	0.921	-179	2.55	74	0.014	46	0.863	-179
110	0.922	-179	2.27	73	0.014	47	0.876	-178
120	0.923	-179	2.08	70	0.015	49	0.867	-179
130	0.923	-180	1.92	70	0.016	51	0.880	-178
140	0.924	-180	1.78	67	0.017	55	0.880	-179
150	0.925	-180	1.68	65	0.018	58	0.904	179
160	0.926	180	1.53	64	0.018	60	0.901	-180
170	0.927	180	1.42	62	0.018	61	0.900	-179
180	0.928	180	1.34	62	0.020	61	0.901	-179
190	0.929	179	1.28	60	0.021	63	0.906	-179
200	0.930	179	1.19	58	0.022	65	0.892	179
210	0.931	179	1.12	56	0.022	67	0.902	178
220	0.932	179	1.06	55	0.023	68	0.903	179
230	0.933	179	0.988	53	0.024	67	0.931	179
240	0.934	178	0.960	53	0.025	69	0.889	179
250	0.934	178	0.910	52	0.026	73	0.877	180
260	0.935	178	0.866	50	0.026	74	0.895	180
270	0.936	178	0.838	49	0.027	74	0.908	180
280	0.937	177	0.803	49	0.029	71	0.923	179
290	0.939	177	0.766	46	0.030	72	0.915	177

**Table 2. Common Source S-Parameters ( $V_{DS} = 24\text{ V}$ ,  $I_D = 4.5\text{ A}$ ) continued**

f MHz	S <sub>11</sub>		S <sub>21</sub>		S <sub>12</sub>		S <sub>22</sub>	
	S <sub>11</sub>	φ	S <sub>21</sub>	φ	S <sub>12</sub>	φ	S <sub>22</sub>	φ
300	0.939	177	0.744	46	0.032	76	0.907	178
310	0.939	177	0.702	46	0.032	81	0.908	180
320	0.940	176	0.660	45	0.031	81	0.913	178
330	0.941	176	0.623	41	0.031	75	0.909	177
340	0.942	176	0.613	42	0.035	71	0.910	178
350	0.943	176	0.599	41	0.039	78	0.905	-180
360	0.943	175	0.585	41	0.040	83	0.913	179
370	0.943	175	0.556	39	0.037	85	0.924	176
380	0.944	175	0.534	38	0.035	80	0.922	175
390	0.944	175	0.512	38	0.037	73	0.907	176
400	0.946	174	0.503	37	0.043	76	0.906	179
410	0.948	174	0.482	36	0.049	81	0.944	177
420	0.948	174	0.464	35	0.047	87	0.940	176
430	0.947	174	0.450	36	0.040	88	0.912	176
440	0.947	173	0.440	36	0.039	79	0.947	176
450	0.948	173	0.445	32	0.047	73	0.944	177
460	0.951	173	0.414	32	0.057	75	0.959	174
470	0.952	173	0.397	32	0.057	86	0.913	176
480	0.951	172	0.387	33	0.050	95	0.908	175
490	0.950	172	0.376	31	0.042	90	0.941	174
500	0.950	172	0.361	31	0.044	74	0.963	175
600	0.957	168	0.287	24	0.073	75	0.932	172
700	0.965	164	0.231	24	0.091	70	0.952	169
800	0.966	160	0.216	23	0.091	67	0.928	163
900	0.979	156	0.205	27	0.112	69	0.930	164
1000	0.981	150	0.206	29	0.146	58	0.947	162

**Table 3. Common Source S-Parameters ( $V_{DS} = 28\text{ V}$ ,  $I_D = 4.5\text{ A}$ )**

f MHz	S <sub>11</sub>		S <sub>21</sub>		S <sub>12</sub>		S <sub>22</sub>	
	S <sub>11</sub>	φ	S <sub>21</sub>	φ	S <sub>12</sub>	φ	S <sub>22</sub>	φ
30	0.910	-173	9.76	87	0.011	17	0.872	-177
40	0.913	-175	6.73	86	0.011	17	0.860	-174
50	0.913	-176	5.69	81	0.011	21	0.849	-179
60	0.913	-177	4.66	81	0.012	26	0.846	-178
70	0.915	-177	3.97	78	0.012	31	0.853	-179
80	0.916	-178	3.39	76	0.012	33	0.858	-178
90	0.916	-178	3.01	74	0.012	34	0.853	-178
100	0.917	-178	2.73	73	0.013	36	0.851	-177
110	0.918	-179	2.42	72	0.014	41	0.849	-177
120	0.919	-179	2.22	68	0.014	48	0.853	-178
130	0.920	-179	2.05	68	0.014	52	0.879	-178
140	0.921	-179	1.90	66	0.014	52	0.894	-178
150	0.922	-180	1.79	64	0.015	51	0.898	-178

**Table 3. Common Source S-Parameters ( $V_{DS} = 28\text{ V}$ ,  $I_D = 4.5\text{ A}$ ) continued**

f MHz	S <sub>11</sub>		S <sub>21</sub>		S <sub>12</sub>		S <sub>22</sub>	
	S <sub>11</sub>	φ	S <sub>21</sub>	φ	S <sub>12</sub>	φ	S <sub>22</sub>	φ
160	0.923	-180	1.63	63	0.016	53	0.880	-177
170	0.924	-180	1.50	61	0.017	58	0.890	-178
180	0.925	180	1.42	60	0.019	62	0.904	-178
190	0.926	180	1.35	58	0.019	64	0.922	-179
200	0.928	179	1.26	56	0.019	63	0.914	-179
210	0.929	179	1.19	54	0.020	62	0.897	-179
220	0.930	179	1.12	53	0.022	64	0.881	-179
230	0.932	179	1.04	51	0.024	67	0.907	180
240	0.932	179	1.01	51	0.024	69	0.892	179
250	0.933	178	0.955	49	0.024	70	0.910	-180
260	0.934	178	0.912	47	0.025	70	0.912	-178
270	0.936	178	0.882	46	0.027	71	0.904	-178
280	0.936	178	0.842	46	0.029	72	0.901	-180
290	0.938	177	0.798	43	0.028	71	0.920	177
300	0.939	177	0.770	44	0.030	71	0.930	178
310	0.939	177	0.731	43	0.032	72	0.934	-179
320	0.941	177	0.690	42	0.035	74	0.939	-180
330	0.942	176	0.655	39	0.036	76	0.895	180
340	0.942	176	0.639	40	0.035	75	0.892	179
350	0.942	176	0.613	39	0.036	75	0.906	-180
360	0.943	175	0.601	38	0.040	71	0.945	179
370	0.945	175	0.577	36	0.045	71	0.960	178
380	0.946	175	0.555	35	0.047	74	0.928	178
390	0.947	175	0.531	35	0.045	79	0.893	178
400	0.946	174	0.518	34	0.042	80	0.892	179
410	0.947	174	0.492	33	0.044	72	0.948	176
420	0.948	174	0.472	32	0.049	67	0.960	176
430	0.950	173	0.462	32	0.056	71	0.936	179
440	0.951	173	0.455	32	0.058	78	0.945	179
450	0.951	173	0.460	30	0.054	82	0.920	177
460	0.950	173	0.424	30	0.050	73	0.951	173
470	0.950	172	0.400	29	0.053	65	0.937	174
480	0.952	172	0.389	29	0.063	65	0.941	175
490	0.954	172	0.382	27	0.071	72	0.960	175
500	0.955	172	0.367	27	0.069	80	0.954	176
600	0.958	168	0.284	22	0.071	80	0.935	172
700	0.967	164	0.226	22	0.088	71	0.950	169
800	0.967	160	0.211	22	0.096	67	0.929	164
900	0.979	156	0.197	26	0.116	69	0.929	165
1000	0.978	150	0.200	29	0.139	67	0.944	163

## RF POWER MOSFET CONSIDERATIONS

### MOSFET CAPACITANCES

The physical structure of a MOSFET results in capacitors between the terminals. The metal oxide gate structure determines the capacitors from gate-to-drain ( $C_{gd}$ ), and gate-to-source ( $C_{gs}$ ). The PN junction formed during the fabrication of the FET results in a junction capacitance from drain-to-source ( $C_{ds}$ ).

These capacitances are characterized as input ( $C_{iss}$ ), output ( $C_{oss}$ ) and reverse transfer ( $C_{rss}$ ) capacitances on data sheets. The relationships between the inter-terminal capacitances and those given on data sheets are shown below. The  $C_{iss}$  can be specified in two ways:

1. Drain shorted to source and positive voltage at the gate.
2. Positive voltage of the drain in respect to source and zero volts at the gate. In the latter case the numbers are lower. However, neither method represents the actual operating conditions in RF applications.

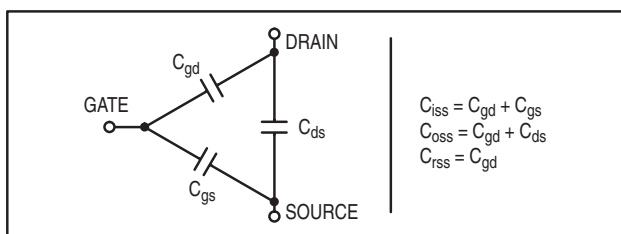

### DRAIN CHARACTERISTICS

One figure of merit for a FET is its static resistance in the full-on condition. This on-resistance,  $V_{DS(on)}$ , occurs in the linear region of the output characteristic and is specified under specific test conditions for gate-source voltage and drain current. For MOSFETs,  $V_{DS(on)}$  has a positive temperature coefficient and constitutes an important design consideration at high temperatures, because it contributes to the power dissipation within the device.

### GATE CHARACTERISTICS

The gate of the FET is a polysilicon material, and is electrically isolated from the source by a layer of oxide. The input resistance is very high — on the order of  $10^9$  ohms — resulting in a leakage current of a few nanoamperes.

Gate control is achieved by applying a positive voltage slightly in excess of the gate-to-source threshold voltage,  $V_{GS(th)}$ .

**Gate Voltage Rating** — Never exceed the gate voltage rating. Exceeding the rated  $V_{GS}$  can result in permanent damage to the oxide layer in the gate region.

**Gate Termination** — The gates of these devices are essentially capacitors. Circuits that leave the gate open-circuited or floating should be avoided. These conditions can result in turn-on of the devices due to voltage build-up on the input capacitor due to leakage currents or pickup.

**Gate Protection** — These devices do not have an internal monolithic zener diode from gate-to-source. If gate protection is required, an external zener diode is recommended.

Using a resistor to keep the gate-to-source impedance low also helps damp transients and serves another important function. Voltage transients on the drain can be coupled to the gate through the parasitic gate-drain capacitance. If the gate-to-source impedance and the rate of voltage change on the drain are both high, then the signal coupled to the gate may be large enough to exceed the gate-threshold voltage and turn the device on.

### HANDLING CONSIDERATIONS

When shipping, the devices should be transported only in antistatic bags or conductive foam. Upon removal from the packaging, careful handling procedures should be adhered to. Those handling the devices should wear grounding straps and devices not in the antistatic packaging should be kept in metal tote bins. MOSFETs should be handled by the case and not by the leads, and when testing the device, all leads should make good electrical contact before voltage is applied. As a final note, when placing the FET into the system it is designed for, soldering should be done with a grounded iron.

### DESIGN CONSIDERATIONS

The MRF275L is a RF power N-channel enhancement mode field-effect transistor (FETs) designed for HF, VHF and UHF power amplifier applications. Motorola FETs feature a vertical structure with a planar design.

Motorola Application Note AN211A, FETs in Theory and Practice, is suggested reading for those not familiar with the construction and characteristics of FETs.

The major advantages of RF power FETs include high gain, low noise, simple bias systems, relative immunity from thermal runaway, and the ability to withstand severely mismatched loads without suffering damage. Power output can be varied over a wide range with a low power dc control signal.

### DC BIAS

The MRF275L is an enhancement mode FET and, therefore, does not conduct when drain voltage is applied. Drain current flows when a positive voltage is applied to the gate. RF power FETs require forward bias for optimum performance. The value of quiescent drain current ( $I_{DQ}$ ) is not critical for many applications. The MRF275L was characterized at  $I_{DQ} = 100$  mA, each side, which is the suggested minimum value of  $I_{DQ}$ . For special applications such as linear amplification,  $I_{DQ}$  may have to be selected to optimize the critical parameters.

The gate is a dc open circuit and draws no current. Therefore, the gate bias circuit may be just a simple resistive divider network. Some applications may require a more elaborate bias system.

### GAIN CONTROL

Power output of the MRF275L may be controlled from its rated value down to zero (negative gain) by varying the dc gate voltage. This feature facilitates the design of manual gain control, AGC/ALC and modulation systems.